

Martin, Robert Cecil.
The Principles, Practices, & Patterns of Agile Software Development
/Robert Cecil Martin.

p. cm.

“An Alan R. Apt Book.”

Includes index.

ISBNxxxxxxxx

Publisher: Alan Apt

Production Editor:

Cover Designer:

Copy Editor:



© 2002 by Prentice-Hall, Inc.

A Simon & Schuster Company

The author and publisher of this book have used their best efforts in preparing this book. These efforts include the development, research, and testing of the theories and programs to determine their effectiveness. The author and publisher shall not be liable in any event for incidental or consequential damages in connection with, or arising out of, the furnishing, performance, or use of these programs.

All rights reserved. No part of this book may be reproduced, in any form or by any means, without permission in writing from the publisher.

Printed in the United States of America

10 9 8 7 6 5 4 3 2 1

ISBN 0-13-203837-4

PRENTICE-HALL INTERNATIONAL (UK) Limited, *London*

PRENTICE-HALL OF AUSTRALIA PTY. LIMITED, *Sydney*

PRENTICE-HALL CANADA, INC., *Toronto*

PRENTICE-HALL HISPANOAMERICANA, S.A., *Mexico*

PRENTICE-HALL OF INDIA PRIVATE LIMITED, *New Delhi*

PRENTICE-HALL OF JAPAN, INC., *Tokyo*

SIMON & SCHUSTER ASIA PTE. LTD., *Singapore*

EDITORIA PRENTICE-HALL DO BRASIL, LTDA., *Rio de Janeiro*

This book is dedicated to my grandchildren:

XXX: the son of Micah and Angelique.

Alexis: the daughter of Angela and Matt.

It has been said that grandchildren are the desert of life.

*If that's so, what am I supposed to do with all the many
main courses I'm not done with yet?*

Source Code and Contact Information:

Much of the source code presented in this book can be obtained from the Object Mentor Inc. web site. www.objectmentor.com/UMLFJP

Robert C. Martin: unclebob@objectmentor.com

Object Mentor Inc.: info@objectmentor.com
www.objectmentor.com

Chapter 1:

Overview of UML for Java Programmers	1
Diagram Types	2
Class Diagrams.....	4
Object Diagrams.....	5
Sequence Diagrams	6
Collaboration Diagrams	6
State Diagrams	7
Conclusion.....	8
Bibliography	8

Chapter 2:

Working with Diagrams	9
Why Model?.....	9
Why build models of software?	10
Why should we build comprehensive designs before coding?	10
Making Effective use of UML	10
Communicating with Others.	11
Back end Documentation	13
What to keep, and What to throw away.	14
Iterative Refinement	15
Behavior first.....	15
Check the structure.....	17
Envisioning the code.	19
Iterative Refinement.....	20
Minimalism	21
When and how to draw diagrams.....	21
When to draw diagrams, and when to stop.	21
CASE Tools.....	22
But what about documentation?.....	23
And Javadocs?.....	23
Conclusion.....	24

Chapter 3:

Class Diagrams	25
-----------------------------	-----------

The Basics	25
Classes	25
Association	26
Multiplicity.....	26
Inheritance	27
An Example Class Diagram	28
The Details	30
Class Stereotypes.....	30
Abstract classes	31
Properties.....	31
Aggregation.....	32
Composition	33
Multiplicity.....	34
Association Stereotypes	35
Inner Classes	36
Anonymous Inner Classes.....	36
Association classes.....	37
Association Qualifiers	38
Conclusion	38
Bibliography	39

Chapter 4:

Sequence Diagrams	41
The Basics	41
Objects, Lifelines, Messages, and other odds and ends.	41
Creation and Destruction.....	43
Simple Loops.....	44
Cases and Scenarios	44
Advanced Concepts	48
Loops and Conditions.....	48
Messages that take time.....	49
Asynchronous Messages.	51
Multiple Threads	53
Active Objects	54
Sending Messages to Interfaces.	54
Conclusion	56

Chapter 5:

Use Cases	57
Writing Use Cases	57
What is a use case.....	58
The Primary Course	58
Alternate Courses	59
What else?	59
Use Cases Diagrams	60
System Boundary Diagram	60
Use Case Relationships	61
Conclusion	61

Chapter 6:

Principles of OOD	63
Design Quality	63
Design Smells.....	63
Dependency Management.....	64
The Single Responsibility Principle (SRP)	64
The Open Closed Principle (OCP)	66
The Liskov Substitution Principle (LSP)	78
The Dependency Inversion Principle (DIP)	80
The Interface Segregation Principle	81
Conclusion	82
Bibliography	83

Chapter 7:

The Practices: dX	85
Iterative Development	85
The Initial Exploration	85
Estimating the features	86
Spikes	87
Planning	87
Planning Releases.....	87
Planning Iterations.....	87
The midpoint.	88

Velocity Feedback.....	89
Organizing the Iterations into Management Phases.....	89
What's in an Iteration?.....	89
Developing in Pairs.....	90
Acceptance Tests.....	90
Unit Tests.....	91
Refactoring.....	91
Open Office.....	92
Continuous Integration.....	92
Conclusion.....	92
Bibliography.....	93

Chapter 8:

Packages.....	95
Java Packages.....	95
Packages.....	95
Dependencies.....	96
Binary Components -- .jar files.....	97
Principles of Package Design.....	97
The Release/Reuse Equivalency Principle (REP).....	98
The Common Closure Principle (CCP).....	98
The Common Reuse Principle (CRP).....	99
The Acyclic Dependencies Principle (ADP).....	99
The Stable Dependencies Principle (SDP).....	99
The Stable Abstractions Principle (SAP).....	100
Conclusion.....	100

Chapter 9:

Object Diagrams.....	103
A Snapshot in Time.....	103
Active Objects.....	105
Conclusion.....	108

Chapter 10:

State Diagrams.....	109
----------------------------	------------

The Basics	109
Special Events	110
Super States	111
Initial and Final Pseudo States	113
Using FSM Diagrams	113
SMC	114
ICE: A Case Study	116
Conclusion	121

Chapter 11:

Heuristics and Coffee	123
The Mark IV Special Coffee Maker	123
A Challenge.....	126
A Common, but Hideous, Coffee Maker Solution.....	126
MissingMethods.....	126
Vapor Classes.....	127
Imaginary Abstraction.....	128
God Classes	129
A Coffee Maker Solution	129
Crossed Wires	130
The Coffee Maker User Interface.....	131
Use Case 1: User pushes brew button.	131
Use Case 2: Containment Vessel not Ready.	132
Use Case 3: Brewing Complete.	132
Use Case 4: Coffee all gone.	134
Implementing the Abstract Model.....	134
Use Case 1. User pushes Brew Button (Mark IV)	135
Implementing the isReady() functions.	136
Implementing the start() functions.	137
How does M4UserInterface.checkBoxButton get called?	138
Completing the Coffee Maker.....	139
The Benefits of this design.....	141
How did I really come up with this design?.....	141

Chapter 12:

SMC Remote Service: Case Study	153
---	-----

Caveat Emptor.....	153
Unit Tests.	154
The SMCRemote System.....	154
SMCRemoteClient	154
SMCRemoteClient Command Line	155
SMCRemote Communication Protocols	155
SMCRemoteClient	157
The Loggers.....	164
The Remote Sessions.	165
RemoteSessionBase	166
The Remote Registrar.....	169
The Remote Compiler	171
FileCarrier	176
SMCRemoteClient Conclusion.....	177
SMCRemoteServer	178
SocketService	178
SMCRemoteService	183
SMCRemoteServer.....	187
ServerSession	190
Three Level FSM	192
UserRepository.....	192
OReillyEmailSender.....	202
PasswordGenerator.....	202
Conclusion.....	203
Tests for SMCRemoteClient	204
Tests for SocketService.....	211
Tests for SMCRemoteServer	214
Other Tests.....	224
ServerController (SMC Generated)	227
Bibliography	235

Overview of UML for Java Programmers

The Unified Modeling Language (UML) is a graphical notation for drawing diagrams of software concepts. One can use it for drawing diagrams of a problem domain, a proposed software design, or an already completed software implementation. Fowler¹ describes these three different levels as *Conceptual*, *Specification*, and *Implementation*. This deals with the last two.

Specification and *Implementation* level diagrams have a strong connection to source code. Indeed it is the intent for a *Specification* level diagram to be turned into source code. Likewise it is the intent for an *Implementation* level diagram to describe existing source code. As such there are rules and semantics that diagrams at these levels must follow. Such diagrams have very little ambiguity, and a great deal of formality.

On the other hand, diagrams at the *Conceptual* level are not strongly related to source code. Rather they are related to *human* language. They are a shorthand used describe concepts and abstractions that exist in the human problem domain. They don't follow strong semantic rules and therefore their meaning can be ambiguous and subject to interpretation.

Consider, for example, the following sentence: *A dog is an animal*. We can create a *Conceptual* UML diagram that represents this sentence. (See Figure 1-1.)

This diagram depicts two entities named *Animal* and *Dog* connected by *generalization* relationship. An *Animal* is a generalization of a *Dog*. A *Dog* is a special case of an *Animal*. That's all the diagram means. Nothing more can be inferred from it. We might be asserting that our pet dog, Sparky, is an animal; or we might be asserting that dogs, as a

1. [Fowler00], p??

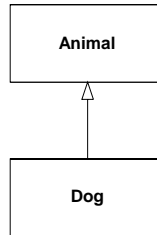

Figure 1-1
A Dog is an Animal

biological species, belong to the animal kingdom. Thus, the diagram is subject to interpretation.

However, the same diagram at the *Specification* or *Implementation* level has a much more precise meaning:

```
public class Animal {}
public class Dog extends Animal {}
```

This source code defines `Animal` and `Dog` as classes connected by an *inheritance* relationship. Whereas the *Conceptual* model says nothing at all about computers, data processing, or programs, the *Specification* model *describes part of a program*.

It is unfortunate that the diagrams themselves don't communicate what level they are drawn at. Failure to recognize the level of a diagram is the source of significant miscommunication between programmers and analysts. A *Conceptual* level diagram *does not* define source code, nor should it. A *Specification* level diagram that describes the solution to a problem does not have to look anything like the *Conceptual* level diagram that describes that problem.

All the rest of the diagrams in this book will be at the *Specification/Implementation* level, and will be accompanied by corresponding source code where feasible. We have seen our last *Conceptual* level diagram.

Diagram Types

Below is a very quick tour of the primary diagrams used in UML. Once you read through it, you will be able to read and write most of the UML diagrams you will usually need. What remains, and what subsequent chapters address, are the details and formalisms that you will need to become proficient in UML.

UML has three main kinds of diagrams. Static diagrams describe the unchanging logical structure of software elements by depicting classes, objects, and data structures; and the relationships that exist between them. Dynamic diagrams show how software entities change during execution by depicting the flow of execution, or the way entities change

state. Physical diagrams show the unchanging physical structure of software entities by depicting physical entities such as source files, libraries, binary files, data files, etc., and the relationships that exist between them.

Consider the code in Listing 1-1. This program implements a map based upon a simple binary tree algorithm. Familiarize yourself with the code before you consider the diagrams that follow.

Listing 1-1
TreeMap.java

```
public class TreeMap {
    TreeMapNode topNode = null;

    public void add(Comparable key, Object value) {
        if (topNode == null)
            topNode = new TreeMapNode(key, value);
        else
            topNode.add(key, value);
    }

    public Object get(Comparable key) {
        return topNode == null ? null : topNode.find(key);
    }
}

class TreeMapNode {
    private final static int LESS = 0;
    private final static int GREATER = 1;
    private Comparable itsKey;
    private Object itsValue;
    private TreeMapNode nodes[] = new TreeMapNode[2];

    public TreeMapNode(Comparable key, Object value) {
        itsKey = key;
        itsValue = value;
    }

    public Object find(Comparable key) {
        if (key.compareTo(itsKey) == 0) return itsValue;
        return findSubNodeForKey(selectSubNode(key), key);
    }

    private int selectSubNode(Comparable key) {
        return (key.compareTo(itsKey) < 0) ? LESS : GREATER;
    }

    private Object findSubNodeForKey(int node, Comparable key) {
        return nodes[node] == null ? null : nodes[node].find(key);
    }

    public void add(Comparable key, Object value) {
        if (key.compareTo(itsKey) == 0)
            itsValue = value;
        else
            addSubNode(selectSubNode(key), key, value);
    }
}
```

Listing 1-1 (Continued)
TreeMap.java

```

private void addSubNode(int node, Comparable key,
                        Object value) {
    if (nodes[node] == null)
        nodes[node] = new TreeMapNode(key, value);
    else
        nodes[node].add(key, value);
}
}

```

Class Diagrams

The *Class Diagram* in Figure 1-2 shows the major classes and relationships in the program. It shows that there is a `TreeMap` class that has public methods named `add` and `get`. It shows that `TreeMap` holds a reference to a `TreeMapNode` in a variable named `topNode`. It shows that each `TreeMapNode` holds a reference to two other `TreeMapNode` instances in some kind of container named `nodes`. And it shows that each `TreeMapNode` instance holds references to two other instances in variables named `itsKey` and `itsValue`. The `itsKey` variable holds a reference to some instance that implements the `Comparable` interface. The `itsValue` variable simply holds a reference to some object.

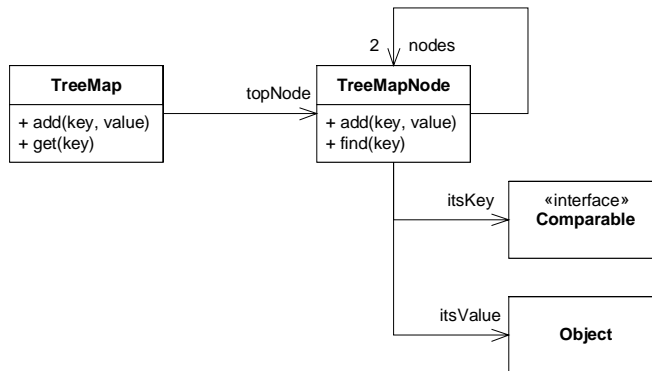

Figure 1-2
Class Diagram of TreeMap

We'll go over the nuances of class diagrams in a subsequent chapter. For now, there are only a few things you need to know.

- Rectangles represent classes, and arrows represent relationships.
- In this diagram all the relationships are *associations*. Associations are simple data relationships in which one object holds a reference to, and invokes methods

upon, the other.

- The name on an association maps to the name of the variable that holds the reference.
- A number next to an arrowhead typically shows the number of instances held by the relationship. If that number is greater than one then some kind of container, usually an array, is implied.
- Class icons can have more than one compartment. The top compartment always holds the name of the class. The other compartments describe functions and variables.
- The «interface» notation means that Comparable is an interface.
- Most of the notations shown are optional.

Look carefully at this diagram and relate it to the code in Listing 1-1. Notice how the association relationships correspond to instance variables. For example, the association from `TreeMap` to `TreeNode` is named `topNode` and corresponds to the `topNode` variable within `TreeMap`.

Object Diagrams

Figure 1-3 is an *Object Diagram*. It shows a set of objects and relationships at a particular moment in the execution of the system. You can view it as a snapshot of memory.

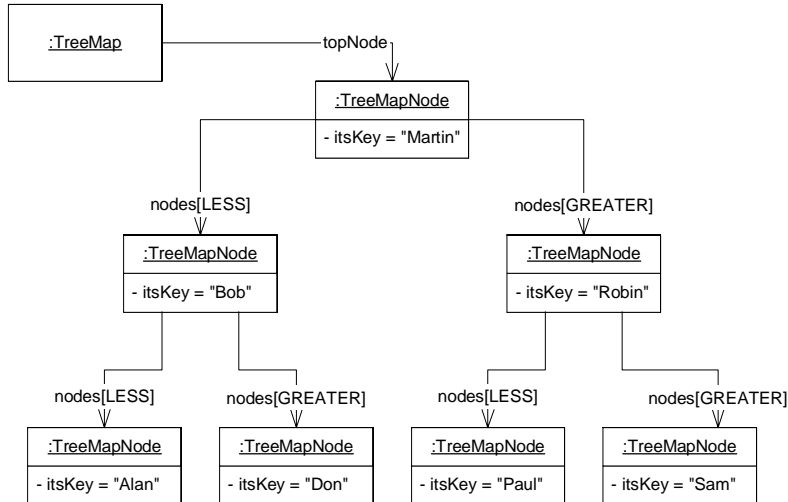

Figure 1-3
TreeMap Object Diagram

In this diagram the rectangle icons represent objects. You can tell that they are objects because their names are underlined. The name after the colon is the name of the class that the object belongs to. Note that the lower compartment of each object shows the value of that object's `itsKey` variable.

The relationships between the objects are called links, and are derived from the associations in Figure 1-3. Note that the links are named for the two array cells in the `nodes` array.

Sequence Diagrams

Figure 1-4 is a *Sequence Diagram*. It describes how the `TreeMap.add` method is implemented.

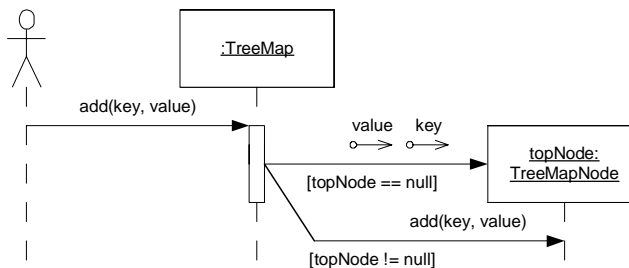

Figure 1-4
TreeMap.add

The stick figure represents an unknown caller. This caller invokes the `add` method on a `TreeMap` object. If the `topNode` variable is `null`, then `TreeMap` responds by creating a new `TreeMapNode` and assigning it to `topNode`. Otherwise the `TreeMap` sends the `add` message to `topNode`.

The boolean expressions inside square brackets are called *guards*. They show which path is taken. The message arrow that terminates on the `TreeMapNode` icon represents construction. The little arrows with circles are called *data tokens*. In this case they depict the construction arguments. The skinny rectangle below `TreeMap` is called an *activation*. It depicts how much time the `add` method executes.

Collaboration Diagrams

The diagram in Figure 1-5 is a *Collaboration Diagram* depicting the case of `TreeMap.add` where `treeNode` is not `null`. Collaboration diagrams contain the same information that sequence diagrams contain. However whereas sequence diagrams make the order of the messages clear, collaboration diagrams make the relationships between the objects clear.

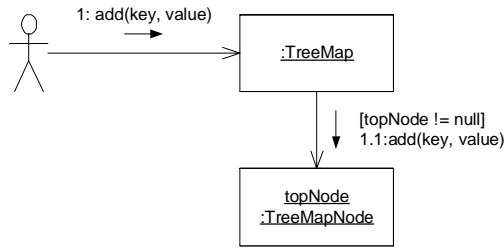

Figure 1-5
Collaboration Diagram of one case of `TreeMap.add`

The objects are connected by relationships called links. A link exists wherever one object can send a message to another. Traveling over those links are the messages themselves. They are depicted as the smaller arrows. The messages are labeled with the name of the message, its sequence number, and any guards that apply.

The dot structure of the sequence number shows the calling hierarchy. The `TreeMap.add` function (message 1) invokes the `TreeMapNode.add` function (message 1.1). Thus message 1.1 is the first message sent by the function invoked by message 1.

State Diagrams

UML has a very comprehensive notation for finite state machines. Figure 1-6 shows just the barest subset of that notation.

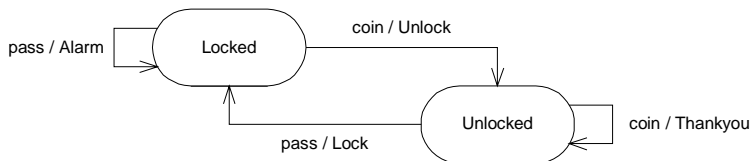

Figure 1-6
State Machine of a Subway Turnstile

Figure 1-6 shows the state machine for a subway turnstile. There are two *states* named `Locked` and `Unlocked`. Two *events* may be sent to the machine. The `coin` event means that the user has dropped a coin into the turnstile. The `pass` event means that the user has passed through the turnstile.

The arrows are called *transitions*. They are labeled with the the *event* that triggers the transition, and the *action* that the transition performs. When a transition is triggered it causes the state of the system to change.

We can translate Figure 1-6 to english as follows:

- If we are in the `Locked` state, and we get a `coin` event, then we transition to the `Unlocked` state and we invoke the `Unlock` function.
- If we are in the `Unlocked` state and we get a `pass` event then we transition to the `Locked` state and we invoke the `Lock` function.
- If we are in the `Unlocked` state and we get a `coin` event, then we stay in the `Unlocked` state and we call the `Thankyou` function.
- If we are in the `Locked` state and we get a `pass` event then we stay in the `Locked` state and we call the `Alarm` function.

Diagrams like this are extremely useful for figuring out the way a system behaves. They give us the opportunity to explore what the system should do in unexpected cases, like when a user drops a coin, and then drops another coin for no good reason.

Conclusion

The diagrams shown in this chapter are enough for most purposes. Most programmers could live without any more knowledge of UML than what is shown here.

Bibliography

[Fowler00]: *UML Distilled*, 2d. ed. Martin Fowler, Addison Wesley, 199?

Working with Diagrams

“Before we explore the details of UML, it would be wise to talk about when and why we use it. Much harm has been done to software projects through the misuse and overuse of UML.

Why Model?

Why do engineers build models? Why do aerospace engineers build models of aircraft? Why do structural engineers build models of bridges? What purposes do these models serve?

These engineers build models to find out if their designs will work. Aerospace engineers build models of aircraft and then put them into wind tunnels to see if they will fly. Structural engineers build models of bridges to see if they will stand. Architects build models of buildings to see if their clients will like the way they look. *Models are built to find out if something will work.*

This implies that models must be testable. It does no good to build a model if there are no criteria you can apply to that model in order to test it. If you can't evaluate the model, the model has no value.

Why don't aerospace engineers just build the plane and try to fly it? Why don't structural engineers just build the bridge and then see if it stands? Because airplanes and bridges are a *lot* more expensive than the models. *We investigate designs with models when the models are much cheaper than the real thing we are building.*

Why build models of software?

Can a UML diagram be tested? Is it much cheaper to create and test than the software it represents? In both cases the answer is nowhere near as clear as it is for aerospace engineers and structural engineers. There are no firm criteria for testing a UML diagram. We can look at it, and evaluate it, and apply principles and patterns to it; but in the end the evaluation is still very subjective. UML diagrams are less expensive to draw than software is to write; but not by a huge factor. Indeed, there are times when it's easier to change source code than it is to change a diagram. So then, does it make sense to use UML?

I wouldn't be writing this book if UML didn't make sense to use. However, the above illustrates just how easy UML is to misuse. *We make use of UML when we have something definitive we need to test, and when using UML to test it is cheaper than using code to test it.*

For example, let's say I have an idea for a certain design. I need to test whether the other developers on my team think it is a good idea. So I write a UML diagram on the whiteboard and ask my teammates for their feedback.

Why should we build comprehensive designs before coding?

Architects, aerospace engineers, and structural engineers all draw blueprints. Why? Because one person can draw the blueprints for a home that will require five or more people to build. A few dozen aerospace engineers can draw blueprints for an airplane that will require thousands of people to build. Blueprints can be drawn without digging foundations, pouring concrete, or hanging windows. In short, it is *much* cheaper to plan a building up front, than it is to try to build it without a plan. It doesn't cost much to throw away a faulty blueprint, but it costs a *lot* to tear down a faulty building.

Once again things are not so clear cut in software. It is not at all clear that drawing UML diagrams is much cheaper than writing code. Indeed, many project teams have spent *more* on their diagrams than they have on the code itself. It is also not clear that throwing away a diagram is much cheaper than throwing away code. Therefore, it is not at all clear that creating a comprehensive UML design before writing code is a cost effective option.

Making Effective use of UML

Apparently neither architecture, nor aerospace engineering, nor structural engineering provide a clear metaphor for software development. We cannot blithely use UML the way those other disciplines use blueprints and models. So when and why *should* we use UML?

Communicating with Others.

UML is enormously convenient for communicating design concepts between software developers. A lot can be done with a small group of developers at a whiteboard. If you have some ideas that you need to communicate to others, UML can be a big benefit.

UML is very good for communicating focussed design ideas. For example, the diagram in Figure 2-1 is very clear. We see the `LoginServlet` implementing the `Servlet` interface and using the `UserDatabase`. Apparently the classes `HttpServletRequest` and `HttpServletResponse` are needed by the `LoginServlet`. One could easily imagine a group of developers standing around a whiteboard debating a diagram like this. Indeed, the diagram makes it very clear what the code structure would look like.

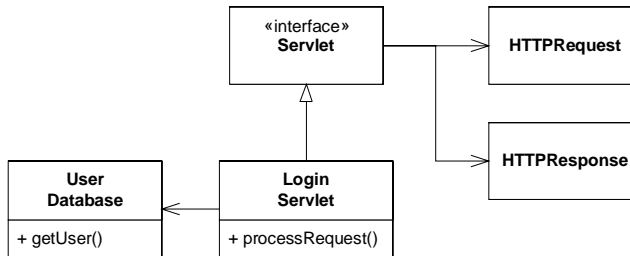

Figure 2-1
Login Servlet

On the other hand, UML is not particularly good for communicating algorithmic detail. Consider the simple bubble sort code in Listing 2-1. Expressing this simple module in UML is not very satisfying..

Listing 2-1 Bubble Sort

```

public class BubbleSorter
{
    static int operations = 0;
    public static int sort(int [] array)
    {
        operations = 0;
        if (array.length <= 1)
            return operations;

        for (int nextToLast = array.length-2;
            nextToLast >= 0; nextToLast--)
            for (int index = 0; index <= nextToLast; index++)
                compareAndSwap(array, index);

        return operations;
    }
}
  
```

```

Listing 2-1 (Continued)
Bubble Sort
private static void swap(int[] array, int index)
{
    int temp = array[index];
    array[index] = array[index+1];
    array[index+1] = temp;
}

private static void compareAndSwap(int[] array, int index)
{
    if (array[index] > array[index+1])
        swap(array, index);
    operations++;
}
}
    
```

The diagram in Figure 2-2 gives us a rough structure, but is combersome and reflects none of the interesting details. The diagram in Figure 2-3 is no eaiser to read than the code and is substantially more difficult to create. UML for these purposes leaves much to be desired.

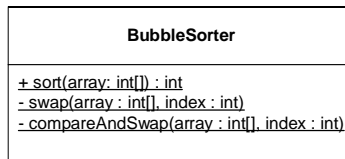

Figure 2-2
Bubble Sorter

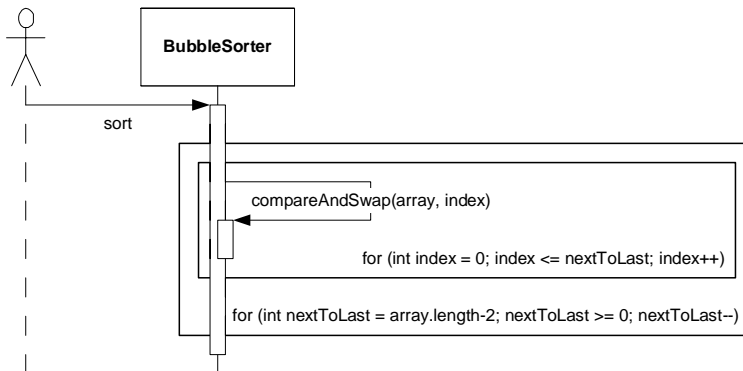

Figure 2-3
Bubble Sort Sequence Diagram

UML can be useful for creating roadmaps of large software structures. Such roadmaps give developers a quick way to find out which classes depend upon which others and provide a reference to the structure of the whole system.

For example, in Figure 2-4 it is easy to see that `Space` objects have a `PolyLine` constructed of many `Lines` which are derived from `LinearObject` which contains two `Points`. Finding this structure in code would be tedious. Finding it in a roadmap diagram is trivial.

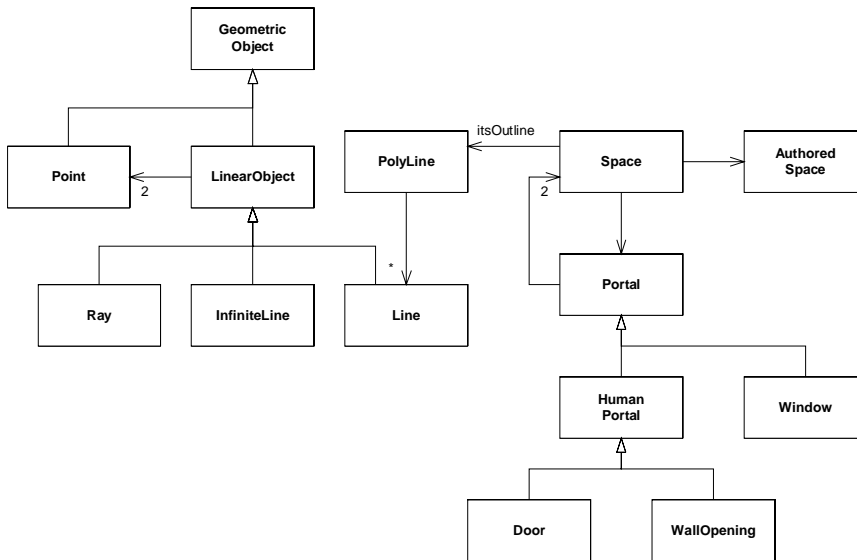

Figure 2-4
Roadmap

Such roadmaps can be useful teaching tools. However, any team member ought to be able to throw such a diagram up on the whiteboard at a moments notice. Indeed, I drew the one above from my memory of a system I was working on five years ago. Such diagrams capture the knowledge that all the developers must keep in their heads in order to work effectively in the system. So, for the most part, there is not much point is going to a lot of trouble to create and archive such documents. Their best use is, once again, at the whiteboard.

Back end Documentation

When is the best time to create a design document? At the end of the project as the last act of the team. Such a document will accurately reflect the state of the design as the team left it, and could certainly be useful to an incoming team.

However, there are some pitfalls. UML diagrams need to be carefully considered. We don't want a thousand pages of sequence diagrams! Rather, we want a few very salient diagrams that describe the major issues in the system. No UML diagram is worse than one that is cluttered with so many lines and boxes that you get lost in the tangle (See Figure 2-5). **Don't do this.**

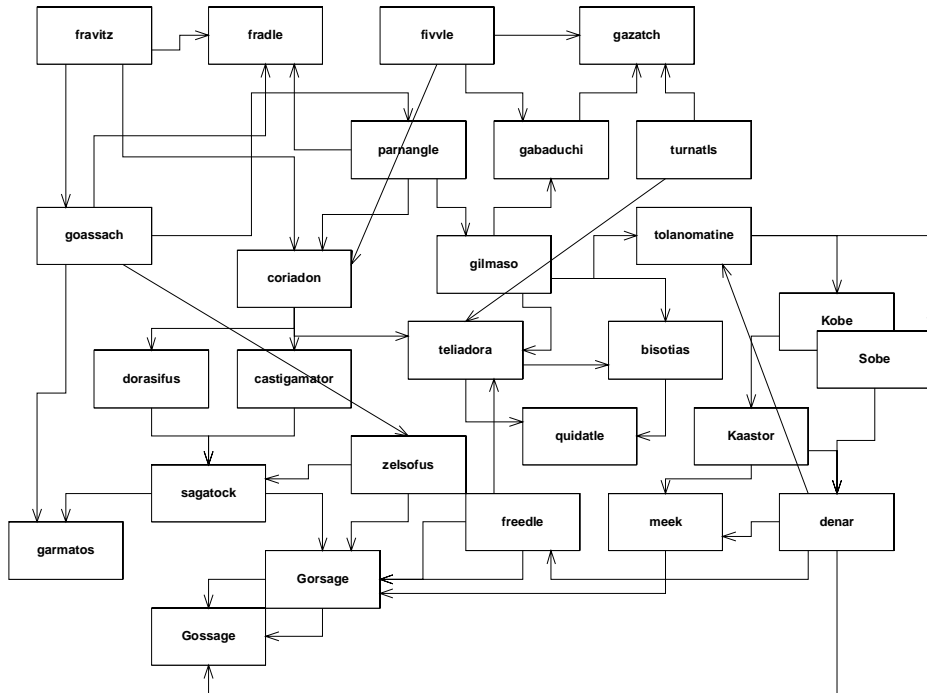

Figure 2-5

What to keep, and What to throw away.

Get into the habit of throwing UML diagrams away. Better yet, get into the habit of not creating them on a persistent medium. Write them on a whiteboard, or on scraps of paper. Erase the whiteboard frequently, and throw the scraps of paper away. Don't use a case tool or a drawing program as a rule. There is a time and place for such tools, but most of your UML should be short-lived.

Some diagrams, however, are useful to save. There are diagrams that express a common design solution in your system. There are diagrams that record complex protocols that are hard to see in the code. There are diagrams that provide roadmaps for areas of the

system that aren't touched very often. There are diagrams that record designer intent in a way that is better than code can express it.

There is no point in hunting for these diagrams; you'll know them when you see them. There's no point in trying to create these diagrams up front. You'll be guessing, and you'll guess wrong. The real useful diagrams will keep showing up over and over again. They'll show up on whiteboards or scraps of paper in design session after design session. Eventually someone will make a persistent copy of the diagram just so it doesn't have to be drawn again. That is the time to place the diagram in some common area that everyone has access to.

It is important to keep common areas convenient and uncluttered. Putting useful diagrams on a web server, or a networked knowledge base, is a good idea. However, don't allow hundreds or thousands of diagrams to accumulate there. Be judicious about what diagrams are truly useful, and which could be recreated by anybody on the team at a moments notice. Keep only those whose long term survival has lots of value.

Iterative Refinement

How do we create UML diagrams? Do we draw them in one brilliant flash of insight? Do we draw the class diagrams first and then the sequence diagrams? Should we scaffold the whole structure of the system first before we flesh in any of the details?

The answer to all these questions is a resounding NO. Anything humans do well they do by taking tiny little steps and then evaluating what they have done. The things that humans do not do well are things that they do in great leaps. We desire to create useful uml diagrams. Therefore we will create them in tiny little steps.

Behavior first.

I like to start with behavior. For those problems where I think UML will help me think the problem through, I'll start by drawing a simple sequence diagram of the problem. Consider, for example, the software that controls a cellular phone. How does this software make the phone call?

We might imagine that the software detects each button press and sends a message to some object that controls dialing. So we'll draw a `Button` object and a `Dialler` object and show the `Button` sending the `digit` message to the `Dialler`.

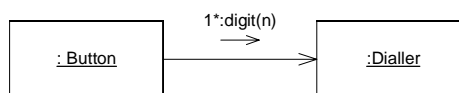

What will the `Dialler` do when it receives the `digit` message? Well, it needs to get the digit displayed on the screen. So perhaps it'll send `displayDigit` to the `Screen` object.

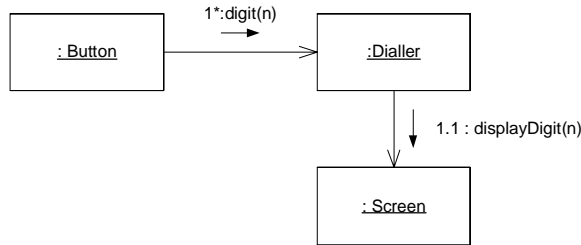

Next the `Dialler` had better cause a tone to be emitted from the speaker. So we'll have it send the `tone` message to the `Speaker` object.

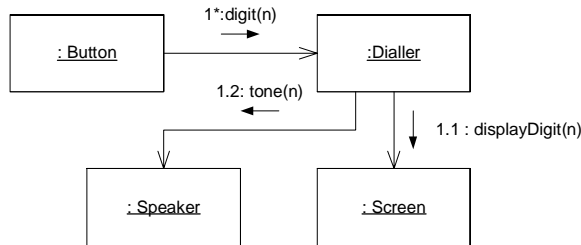

At some point the user will press the “send” button indicating that he wants the call to go through. At that point we'll have to tell the cellular radio to connect to the cellular network and pass along the phone number that was dialed.

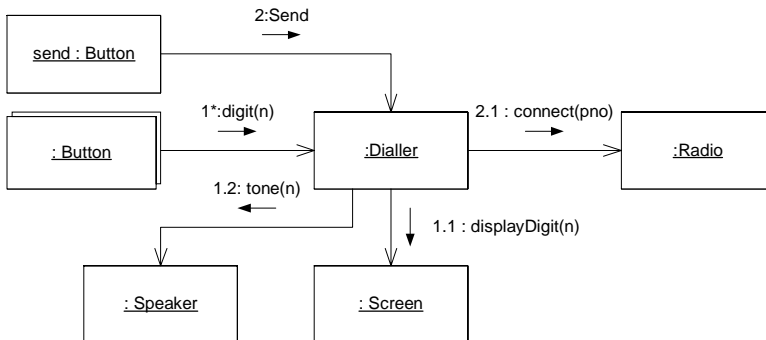

Once the connection has been established, the `Radio` can tell the `Screen` to light up the “in use” indicator. This message will almost certainly be sent in a different thread of control (which is denoted by the letter in front of the sequence number). The final collaboration diagram is shown in Figure 2-6.

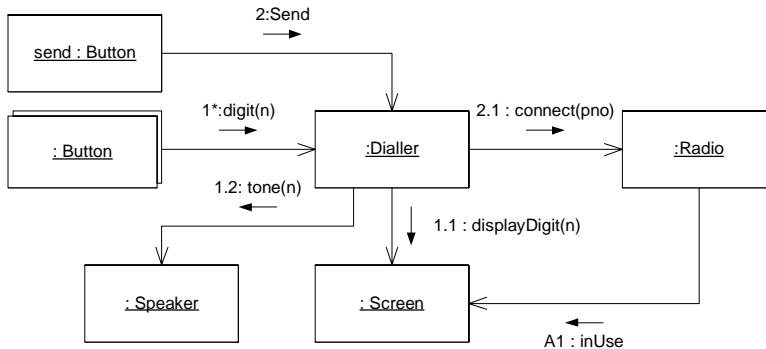

Figure 2-6
Cell Phone Collaboration Diagram

Check the structure

This little exercise has shown how we build a collaboration from nothing. Notice how we invented objects along the way. We didn't know these objects were going to be there ahead of time, we just knew we needed certain things to happen, so we invented objects to do them.

But now, before we go much further, we need to examine what this collaboration means to the structure of the code. So we'll create a class diagram that supports the collaboration. This class diagram will have a class for each object in the collaboration, and an association for each link in the collaboration.

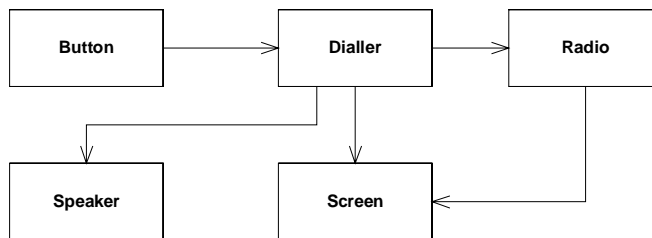

Figure 2-7
Cell Phone Class Diagram

Those of you who are familiar with UML will note that I have ignored aggregation and composition. That's intentional. There'll be plenty of time to consider whether any of those relationships apply or not.

What's important to me right now is an analysis of the dependencies. Why should `Button` depend upon `Dialler`? If you think about this, it's pretty hideous. Consider the implied code:

```
public class Button
{
    private Dialler itsDialler;
    public Button(Dialler dialler)
    {itsDialler = dialler;}
    ...
}
```

I don't want the source code of `Button` mentioning the source code of `Dialler`. `Button` is a class that I can use in many different contexts. For example, I'd like to use the `Button` class to control the on/off switch, or the menu button, or the other control buttons on the phone. If I bind the `Button` to the `Dialler`, then I won't be able to reuse the `Button` code for other purposes.

I can fix this by inserting an interface between `Button` and `Dialler` as shown in Figure 2-8. Here we see that each `Button` is given a token that identifies it. When the `Button` class detects that the real button has been pressed, it invokes the `buttonPressed` method of the `ButtonListener` interface, passing the token. This breaks the dependence of `Button` upon `Dialler` and allows `Button` to be used virtually anywhere that needs to receive button presses..

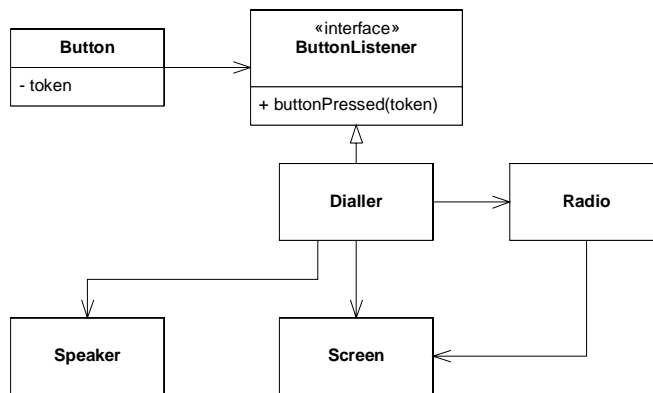

Figure 2-8
Isolating `Button` from `Dialler`

Notice that this change has had no effect upon the dynamic diagram in Figure 2-6. The objects are all the same, it's just the classes that have changed.

Unfortunately now we've made `Dialler` know something about `Button`. Why should `Dialler` expect to get its input from `ButtonListener`? Why should it have a

method within it named `buttonPressed`? What has the `Dialler` got to do with `Button`?

We can solve this problem, and get rid of all the token nonsense, by using a batch of little adapters. The `ButtonDiallerAdapter` implements the `ButtonListener` interface. It receives the `buttonPressed` method and sends a `digit(n)` message to the `Dialler`. The `digit` passed to the `Dialler` is held in the adapter.

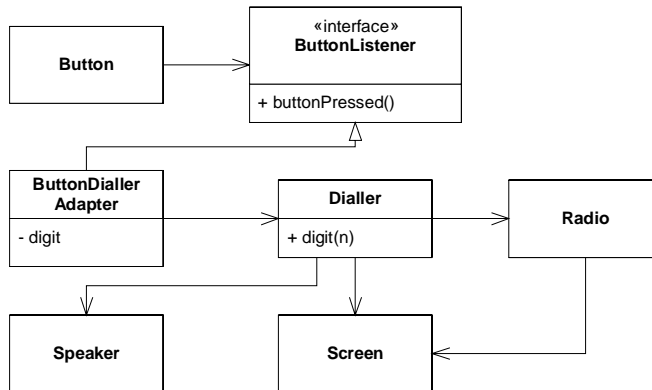

Figure 2-9
Adapting Buttons to Diallers

Envisioning the code.

We can easily envision the code for the `ButtonDiallerAdapter`. It appears in Listing 2-2. Being able to envision the code is critically important when working with diagrams. We use the diagrams as a shortcut for code, not a replacement for it. If you are drawing diagrams and cannot envision the code that they represent, then you are building castles in the air. *Stop what you are doing, and figure out how to translate it to code.* Never let the diagrams become an end unto themselves. You must always be sure you know what code you are representing.

Listing 2-2 `ButtonDiallerAdapter.java`

```

public class ButtonDiallerAdapter implements ButtonListener
{
    private int digit;
    private Dialler dialler;
    public ButtonDiallerAdapter(int digit, Dialler dialler)
    {
        this.digit = digit;
        this.dialler = dialler;
    }
}
  
```

<p>Listing 2-2 ButtonDiallerAdapter.java</p> <pre> public void buttonPressed() { dialler.digit(digit); } </pre>
--

Iterative Refinement

Note that the last change we made in Figure 2-9 has invalidated the dynamic model back in Figure 2-6. The dynamic model knows nothing of the adapters. We'll change that now. See Figure 2-10.

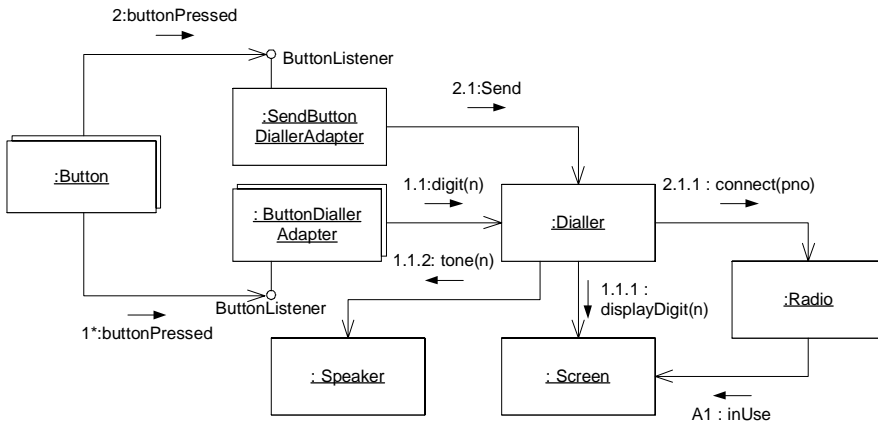

Figure 2-10
 Adding Adapters to the Dynamic Model

This shows how the diagrams evolve together in an iterative fashion. You start with a little bit of dynamics. Then you explore what those dynamic imply to the static relationships. You alter the static relationships according to the principles of good design. Then you go back and improve the dynamic diagrams.

Each of these steps in *tiny*. We don't want to invest any more than 5 minutes into a dynamic diagram before exploring the static structure implied. We don't want to spend any more than 5 minutes refining that static structure before we consider the impact on the dynamic behavior. Rather, we want to evolve the two diagrams together using very short cycles.

Remember, we're probably doing this at a whiteboard, and we are probably not recording what we are doing for posterity. We aren't trying to be very formal or very precise. Indeed, the diagrams I have included in the figures above are a bit more precise and

formal than you would normally have to be. The goal at the whiteboard is not to get all the dots right on your sequence numbers. The goal is to get everybody standing at the board to understand the discussion. The goal is to stop working at the board and start writing code.

Minimalism

This book will show you all the various widgets and icons you can adorn a UML diagram with. Using these adornments you can make your diagrams very complex. It is possible to represent an amazing amount of detail in a UML diagram. However, I advise against this.

As we'll discuss below, diagrams are most useful for communicating with other, and for helping you work out design problems. It is important that you only use the amount of detail necessary to accomplish your goal. Loading a diagram up with lots of adornments is possible, but counter-productive. Keep your diagrams simple and clean. UML diagrams are not source code and should not be treated as the place to declare every method, variable, and relationship.

When and how to draw diagrams.

Drawing UML diagrams can be a very useful activity. It can also be a horrible waste of time. A decision to use UML can be a very good thing, or it can be a very bad thing. It depends upon how, and how much, you choose to use it.

When to draw diagrams, and when to stop.

Don't make a rule that everything must be diagrammed. Such rules are worse than useless. Enormous amounts of project time and energy can be wasted in pursuit of diagrams that no one will ever read.

When to draw diagrams:

- Draw diagrams when several people need to understand the structure of a particular part of the design because they are all going to be working on it simultaneously. Stop when everyone agrees that they understand.
- Draw diagrams when two or more people disagree on how a particular element should be designed, and you want team consensus. Put the discussion into a timebox choose a means for deciding, like a vote, or an impartial judge. Stop at the end of the timebox, or when the decision can be made. Then erase the diagram.
- Draw diagrams when you just want to play with a design idea, and the diagrams can help you think it through. Stop when you've gotten to the point that you can finish your thinking in code. Discard the diagrams.

- Draw diagrams when you need to explain the structure of some part of the code to someone else, or to yourself. Stop when the explanation would be better done by looking at code.
- Draw diagrams when it's close to the end of the project and your customer has requested them as part of a documentation stream for others.

When **not** to draw diagrams:

- Don't draw diagrams because the process tells you to.
- Don't draw diagrams because you feel guilty not drawing them or because you think that's what good designers do. Good designers write code and draw diagrams only when necessary.
- Don't draw diagrams to create comprehensive documentation of the design phase prior to coding. Such documents are almost never worth anything and consume immense amounts of time.
- Don't draw diagrams for other people to code. True software architects participate in the coding of their designs, so that they can lay in the bed they have made.

CASE Tools.

UML CASE tools can be beneficial, but they can also be expensive dust collectors. Be very careful about making a decision to purchase and deploy a UML CASE tool.

- ***Don't UML CASE tools make it easier to draw diagrams?***
No, they make it significantly harder. There is a long learning curve to get proficient; and even then the tools are more cumbersome than whiteboards. Whiteboards are very easy to use. Developers are usually already familiar with them. If not, there is virtually no learning curve.
- ***Don't UML CASE tools make it easier for large teams to collaborate on diagrams?***
In some cases. However, the vast majority of developer and development projects do not need to be producing diagrams in such quantities and complexities that they require an automated collaborative system to coordinate their activities. In any case, the best time to purchase a system to coordinate the preparation of UML diagrams is when a manual system has first been put in place, is starting to show the strain, and there is no other choice but to automate.
- ***Don't UML CASE tools make it easier to generate code?***
The sum total effort involved in creating the diagrams, generating the code, and then using the generated code is not likely to be less than the cost of just writing the code in the first place. If there is a gain, it is not an order of magnitude, or even a factor of two. Developers know how to edit text file and use IDEs. Gener-

ating code from diagrams may sound like a good idea; but I strongly urge you to measure the productivity increase before you spend a lot of money.

- ***What about these CASE tools that are also IDEs and show the code and diagrams together?***

These tools are definitely cool. However, I don't think the constant presence of UML is important. The fact that the diagram changes as I modify the code, or that the code changes as I modify the diagram, does not really help me much. Frankly, I'd rather buy an IDE that has put its effort on figuring out how to help me manipulate my programs than my diagrams. Again, measure productivity improvement before making a huge monetary commitment.

In short, look before you leap, and look very hard. There *may* be a benefit to outfitting your team with an expensive CASE tool; but verify that benefit with your own experiments before buying something that could very well turn into shelfware.

But what about documentation?

Good documentation is essential to any project. Without it the team will get lost in a sea of code. On the other hand, too much documentation of the wrong kind is worse; because then you have all this distracting and misleading paper, and you still have the sea of code.

Documentation must be created, but it must be created prudently. Often the choice *not* to document is just as important as the choice to document. A complex communication protocol needs to be documented. A complex relational schema needs to be documented. A complex reusable framework needs to be documented.

However, none of these things needs a hundred pages of UML. Software documentation should be *short, and to the point*. The value of a software document is inversely proportional to its size.

For a project team of 12 people working on a project of a million lines of Java, I would have a total of 25 to 200 pages of persistent documentation, with my preference being for the smaller. These documents would include UML diagrams of the high level structure of the important modules, ER diagrams of the relational schema, a page or two about how to build the system, testing instructions, source code control instructions, etc.

I would put this documentation into a wiki, or some collaborative authoring tool so that anyone on the team can have access to it on their screens and search it, and anyone can change it as need be.

It takes a lot of work to make a document small, but that work is worth it. People will read small documents. They won't read 1,000 pages tomes.

And Javadocs?

Javadocs are excellent tools. Create them. But keep them small and focussed. Those that describe functions that others will use, should be written with care, and should contain

enough information to help the user understand. Javadocs that describe private utility functions or methods that aren't for wide distribution can be much smaller.

Conclusion

A few folks at a whiteboard can use UML to help them think through a design problem. Such diagrams should be created iteratively, in very short cycles. It is best to explore dynamic scenarios first, and then determine their implications on static structure. It is important to evolve the dynamic and static diagrams together using very short iterative cycles on the order of 5 minutes or less.

UML CASE tools can be beneficial in certain cases; but for the normal development team they are likely to be more of a hindrance than a help. If you think you need a UML CASE tool; even one integrated with an IDE, run some productivity experiments first. Look before you leap.

UML is a tool, not an end in itself. As a tool, it can help you think through your designs and communicate them to others. Use it sparingly and it will give you great benefit. Overuse it and it will waste a lot of your time. When using UML, think small.

Class Diagrams

UML class diagrams allow us to denote the static contents of, and relationships between classes. In a class diagram we can show the member variables, and member functions of a class. We can also show whether one class inherits from another, or whether it holds a reference to another. In short, we can depict all the *source code dependencies* between classes.

This can be valuable. It can be much easier to evaluate the dependency structure of a system from a diagram than from source code. Diagrams make certain dependency structures visible. We can *see* dependency cycles, and determine how best to break them. We can see when abstract classes depend upon concrete classes, and determine a strategy for rerouting such dependencies. .

The Basics

Classes

Figure 3-1 shows the simplest form of class diagram. The class named `Dialler` is represented as a simple rectangle. This diagram represents nothing more than the code shown to its right.

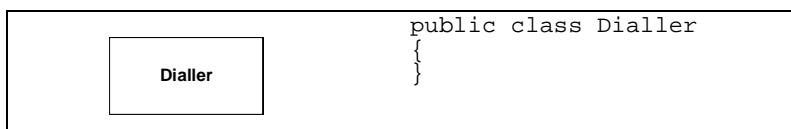

Figure 3-1
Class Icon

This is the most common way you will represent a class. The classes on most diagram don't need any more than their name to make clear what is going on.

A class icon can be subdivided into compartments. The top compartment is for the name of the class, the second is for the variables of the class, and the third is for the methods of the class. Figure 3-2 shows these compartments and how they translate into code.

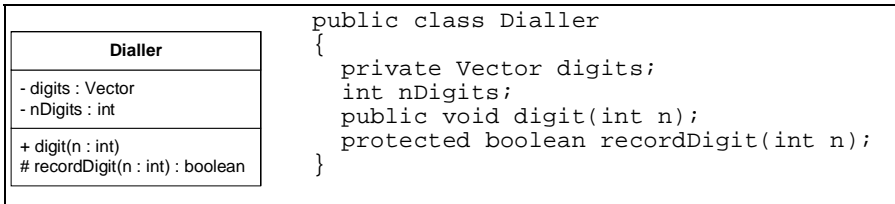

Figure 3-2

Notice the character in front of the variables and functions in the class icon. A dash (-) denotes private, hash (#) denotes protected, and plus (+) denotes public.

The type of a variable, or a function argument is shown after the colon following the variable or argument name. Similarly, the return value of a function is shown after the colon following the function.

This kind of detail is sometimes useful; but should not be used very often. UML diagrams are not the place to declare variables and function. Such declarations are better done in source code. Use these adornments only when they are essential to the purpose of the diagram.

Association

Associations between classes most often represent instance variables that hold references to other objects. For example, in Figure 3-3 we see an association between Phone and Button. The direction of the arrow tells us that Phone holds a reference to Button. The name near the arrowhead is the name of the instance variable. The number near the arrowhead tells us how many references are held.

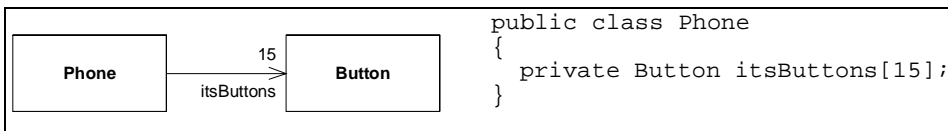

Figure 3-3

Multiplicity

The number near the arrowhead represents the number of objects that connected to the other associate. In Figure 3-3 above we saw that fifteen Button objects were connected to

the Phone object. Below, in Figure 3-4, we see what happens when there is no limit. A Phonebook is connected to *many* PhoneNumber objects. The star means *many*. In Java this is most commonly implemented with a Vector, a List, or some other container type.

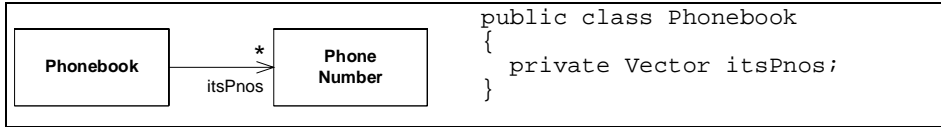

Figure 3-4

Why didn't I use HASA? You may have noticed that I avoided using the word “has”. I could have said: “A Phonebook has many PhoneNumbers.” This was intentional. The common OO verbs HASA and ISA have led to a number of unfortunate misunderstandings. We'll explore some of them later in Chapter 6. For now, don't expect me to use the common terms. Rather, I'll use terms that are descriptive of what actually happens in software.

Inheritance

You have to be very careful with your arrowheads in UML. Figure 3-5 shows why. The little arrowhead pointing at Employee denotes *inheritance*¹. If you draw your arrowheads carelessly, it may be hard to tell whether you mean inheritance or association. To make it clearer, I often make inheritance relationships vertical and associations horizontal.

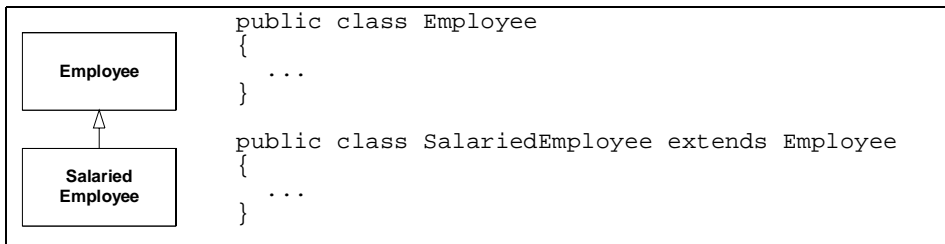

Figure 3-5

In UML all arrowheads point in the direction of *source code dependency*. Since it is the SalariedEmployee class that mentions the name of Employee, the arrowhead points at Employee. So, in UML, inheritance arrows point at the base class.

UML has a special notation for the kind of inheritance used between a Java class and a Java interface. It is shown, in Figure 3-6, as a dashed inheritance arrow². In the diagrams to come, you'll probably catch me forgetting to dash the arrows that point to interfaces. I

-
1. Actually, it denotes *Generalization*, but as far as a Java programmer is concerned, the difference is moot.
 2. This is called a *Realizes* relationship. There's more to it than just inheritance of interface, but the difference is beyond the scope of this book.

suggest you forget to dash the arrows that you draw on whiteboards too. Life's too short to be dashing arrows.

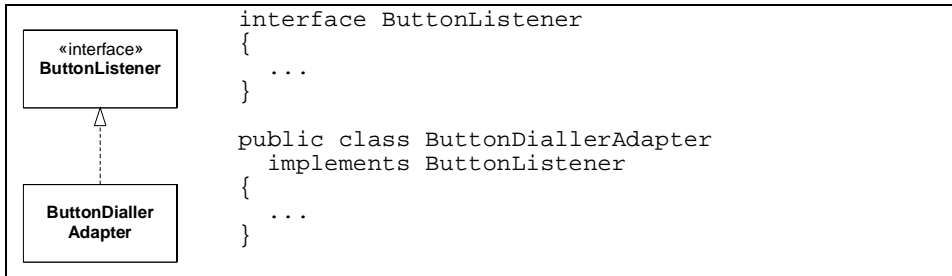

Figure 3-6

Figure 3-7 shows another way to convey the same information. Interfaces can be drawn as little lollipops on the classes that implement them. We often see this kind of notation in COM designs.

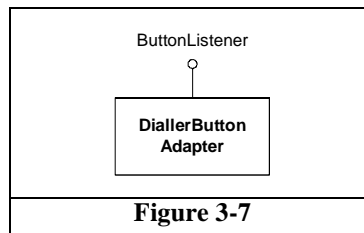

Figure 3-7

An Example Class Diagram

Figure 3-8 shows a simple class diagram of part of an ATM system. This diagram is interesting both for what it shows, and for what it does not show. Note that I have taken pains to mark all the interfaces. I consider it crucial to make sure my readers know what classes I intend to be interfaces and which I intend to be implemented. For example, the diagram immediately tells you that `WithdrawTransaction` talks to a `CashDispenser` interface. Clearly some class in the system will have to implement the `CashDispenser`, but in this diagram we don't care which class it is.

Note that I have not been particularly thorough in documenting the methods of the various UI interfaces. Certainly `WithdrawLUI` will need more than just the two methods shown there. What about `promptForAccount` or `informCashDispenserEmpty`? Putting those methods in the diagram would just clutter it. By providing a representative batch of methods, I've given the reader the idea. That's all that's really necessary.

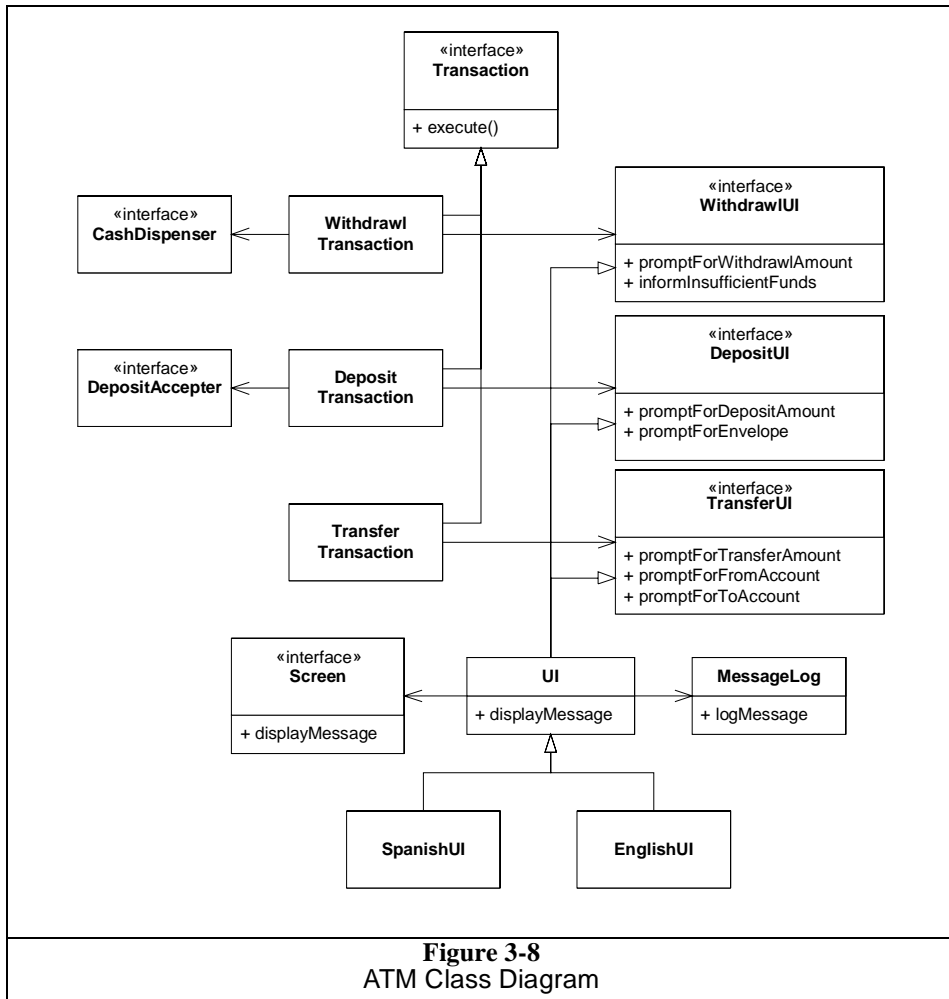

Figure 3-8
ATM Class Diagram

Again note the convention of horizontal association and vertical inheritance. This really helps to differentiate these vastly different kinds of relationships. Without a convention like this it can be hard to tease the meaning out of the tangle.

Notice how I've separated the diagram into three distinct zones. The transactions and their actions are on the left, the various UI interfaces are all on the right, and the UI implementation is on the bottom. Note also that the connections between the groupings are minimal and regular. In one case it is three associations, all pointing the same way. In the other case it is three inheritance relationships all merged into a single line. The grouping, and the way they are connected help the reader to see the diagram in coherent pieces.

You should be able to *see* the code as you look at the diagram. Is Listing 3-1 close to what you expected for the implementation of UI?

Listing 3-1
UI.java

```

public class UI implements
    WithdrawlUI, DepositUI, TransferUI
{
    private Screen itsScreen;
    private MessageLog itsMessageLog;

    public void displayMessage(String message)
    {
        itsMessageLog.logMessage(message);
        itsScreen.displayMessage(message);
    }
}

```

The Details

There are a vast number of details and adornments that can be added to UML class diagrams. Most of the time these details and adornments should not be added. But there are times when they can be helpful.

Class Stereotypes

Class stereotypes appear between guilmette³ characters, usually above the name of the class. We have seen them before. The **«interface»** denotation in Figure 3-8 is a class stereotype. «interface» is one of two standard stereotypes that can be used by java programmers. The other is «utility».

«interface». All the methods of classes marked with this stereotype are abstract. None of the methods can be implemented. Moreover, «interface» classes can have no instance variables. The only variables they can have are static variables. This corresponds exactly to java interfaces. See Figure 3-9.

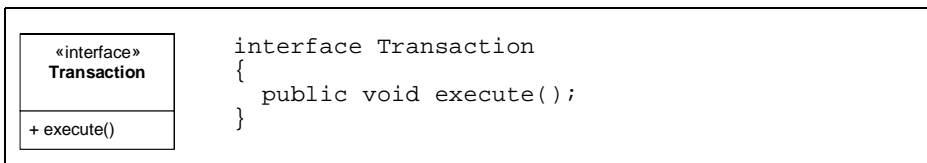
**Figure 3-9**

«utility». All the methods and variables of a «utility» class are static. Booch⁴ used to call these *class utilities*. See Figure 3-10.

-
3. The quotation marks that look like double angle brackets « ». These are *not* two less-than, and two greater-than signs. If you use doubled inequality operators instead of the appropriate and proper guilmette characters, the UML police *will* find you.
 4. [Booch94], p. 186

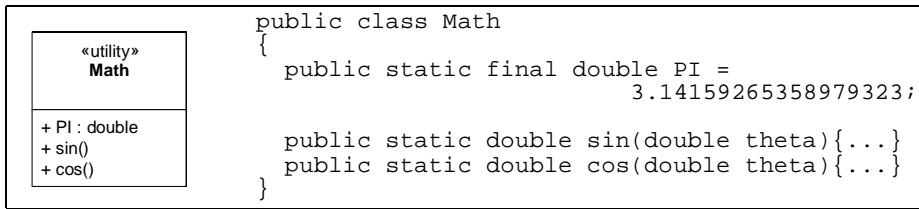

Figure 3-10

You can make your own stereotypes if you like. I often use stereotypes like «persistent», «C-API», «struct», or «function». You just have to make sure that the people who are reading your diagrams know what your stereotype means.

Abstract classes

In UML there are two ways to denote that a class, or a method, is abstract. You can write the name in italics, or you can use the {abstract} property. Both options are shown in Figure 3-11.

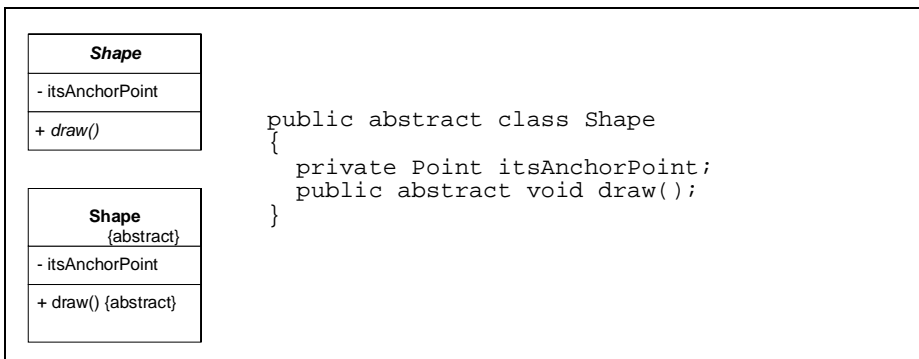

Figure 3-11

It's a little difficult to write italics at a whiteboard, and the {abstract} property is wordy. So at the whiteboard, if I need to denote a class or method as abstract, I use the convention shown in Figure 3-12. This isn't legal UML, but at the whiteboard it is a lot more convenient⁵.

Properties

Properties, like {abstract} can be added to any class. They represent extra information that's not usually part of a class. You can create your own properties at any time.

5. Some of you may remember the Booch notation. One of the nice things about that notation was it's convenience. It was truly a whiteboard notation.

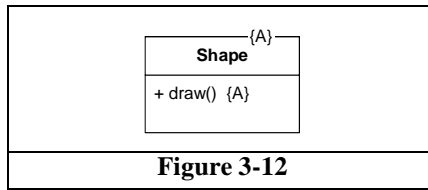

Figure 3-12

Properties are written in a comma separated list of name value pairs like this:

```
{author=Martin, date=20020429, file=shape.java, private}
```

The properties in the above example are not part of UML. The {abstract} property is the only defined property of UML that java programmers would find useful.

If a property does not have a value, it is assumed to take the boolean value true. Thus {abstract} and {abstract = true} are synonyms.

Properties are written below and to the right of the name of the class as shown in Figure 3-13.

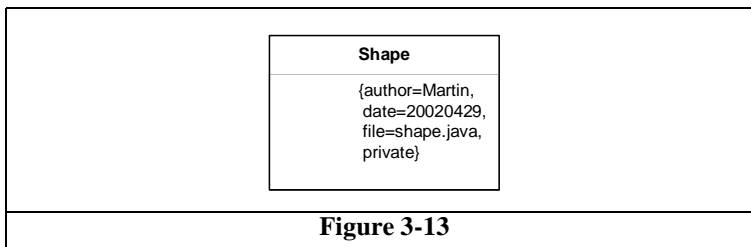

Figure 3-13

Other than the {abstract} property, I don't know when you'd this useful. Personally, in the many years that I've been writing UML diagrams, I've never had occasion to use class properties for anything.

Aggregation

Aggregation is a special form of association that connotes a "whole/part" relationship. Figure 3-14 shows how it is drawn and implemented. Notice that the implementation shown in Figure 3-14 is indistinguishable from association. That's a hint.

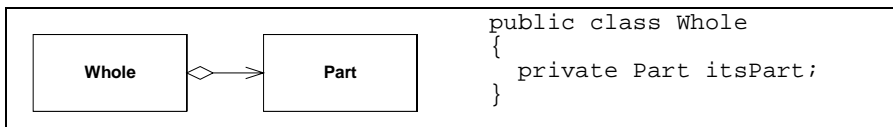
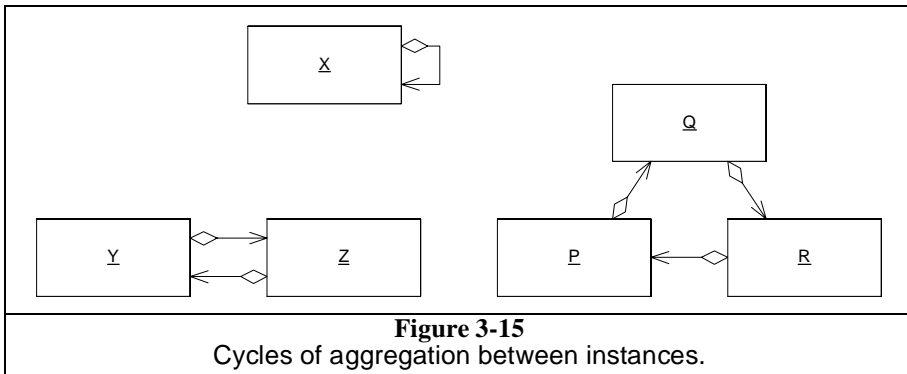

Figure 3-14

Unfortunately, UML does not provide a strong definition for this relationship. This leads to confusion because various programmers and analysts adopt their own pet defini-

tions for the relationship. For that reason, I don't use the relationship at all; and I recommend that you avoid it as well.

The one hard rule that UML gives us regarding aggregations is simply this. A whole cannot be its own part. Therefore *instances* cannot form cycles of aggregations. A single object cannot be an aggregate of itself; two objects cannot be aggregates of each other; three objects cannot form a ring of aggregation, etc. See Figure 3-15



I don't find this to be a particularly useful definition. How often am I concerned about making sure that instances form a directed acyclic graph? Not very often. Therefore I find this relationship useless in the kinds of diagrams I draw.

Composition

Composition is a special form of aggregation shown in Figure 3-16. Again, notice that the implementation is indistinguishable from association. However, this time the reason is not due to a lack of definition; this time it's because the relationship does not have a lot of use in a Java program. C++ programmers, on the other hand, find a *lot* of use for it.

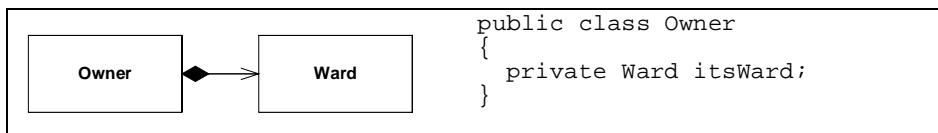

The same rule applies to Composition that applied to aggregation. There can be no cycles of instances. An owner cannot be its own ward. However UML provides quite a bit more definition.

- An instance of a ward cannot be simultaneously owned by two owners. The object diagram in Figure 3-17 is illegal. Note, however, that the corresponding class diagram is not illegal. An owner can transfer ownership of a ward to another owner.

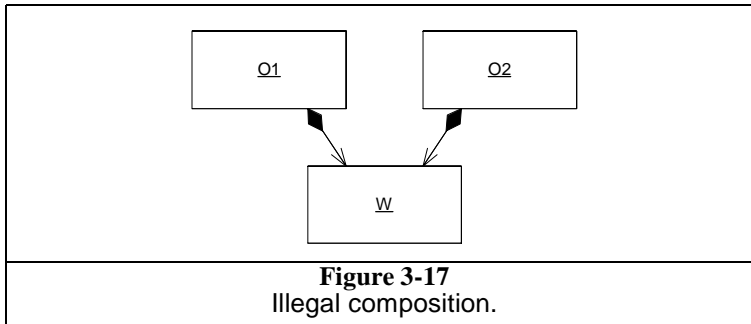

- The owner is responsible for the lifetime of the ward. If the owner is destroyed, the ward must be destroyed with it. If the owner is copied, the ward must be copied with it.

In Java destruction happens behind the scenes by the garbage collector, so there is seldom a need to manage the lifetime of an object. Deep copies are not unheard of, but the need to show deep copy semantics on a diagram is rare. So, though I have used composition relationships to describe some Java programs, such use is infrequent.

Figure 3-18 shows how composition is used to denote deep copy. We have a class named `Address` which holds many `Strings`. Each string holds one line of the address. Clearly, when you make a copy of the `Address`, you want the copy to change independently of the original. Thus, we need to make a deep copy. The composition relationship between the `Address` and the `Strings` indicates that copies need to be deep⁶.

Multiplicity

Objects can hold arrays or vectors of other objects; or they can hold many of the same kind of object in separate instance variables. In UML this can be shown by placing a *multiplicity* expression on the far end of the association. Multiplicity expressions can be simple numbers, ranges, or a combination of both. For example Figure 3-19 shows a `BinaryTreeNode`, using a multiplicity of 2.

Here are the allowable forms:

- Digit. The exact number of elements
- * or 0..* zero to many.
- 0..1 Zero or one. In Java this is often implemented with a reference that can be null.
- 1..* One to many.
- 3..5 Three to five.
- 0, 2..5, 9..* Silly, but legal.

6. Exercise: Why was it enough to clone the `itsLines` vector? Why didn't I have to clone the actual `String` instance?

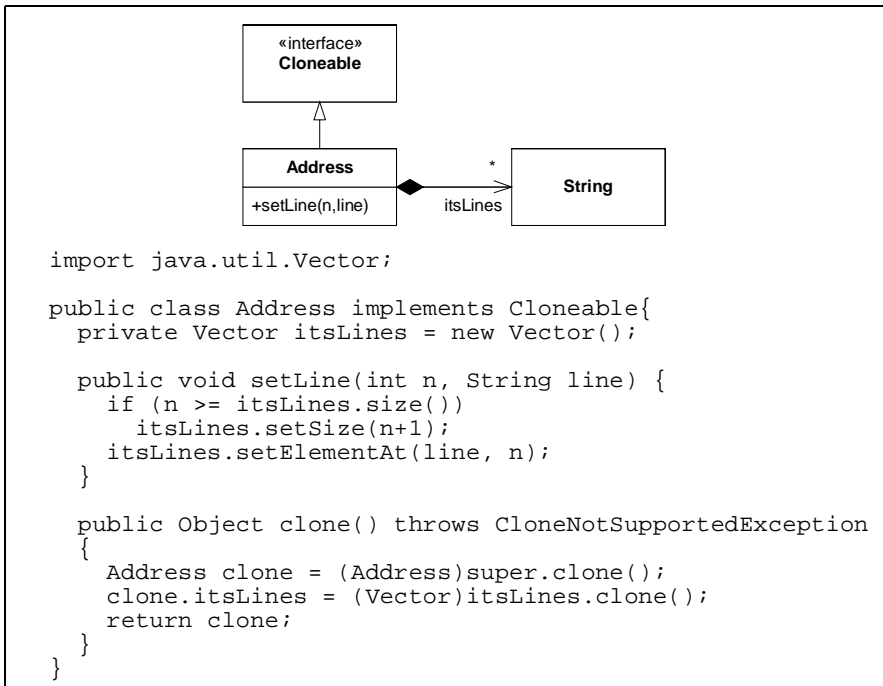

Figure 3-18
DeepCopy is implied by Composition

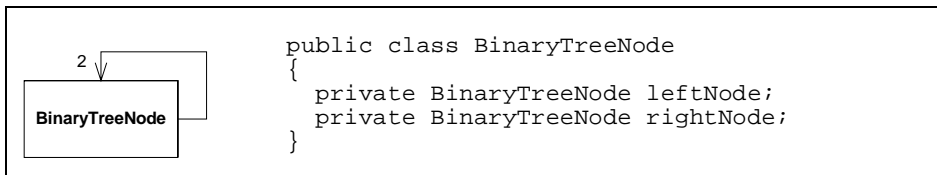

Figure 3-19
Simple multiplicity

Association Stereotypes

Associations can be labeled with stereotypes that change their meaning. Figure 3-20 shows the ones that I use most often. All but the last are standard UML.

The **«creates»** stereotype indicates that the target of the association is created by the source. The implication is that the source creates the target and then passes it around to other parts of the system. In the example I've shown a typical factory.

The **«local»** stereotype is used when the source class creates an instance of the target and holds it in a local variable. The implication is that the created instance does not sur-

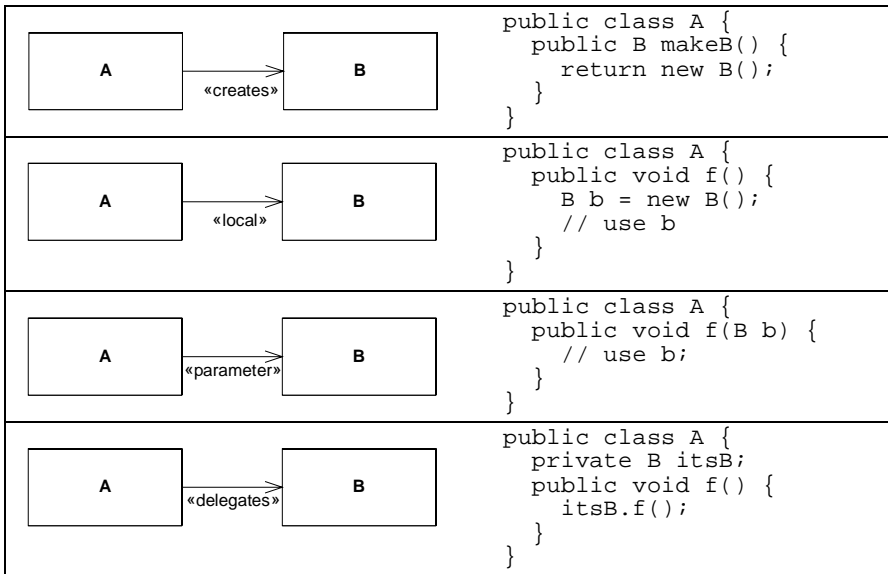

Figure 3-20

vive the member function that creates it. Thus, it is not held by any instance variable nor passed around the system in any way.

The **«parameter»** stereotype shows that the source class gains access to the target instance though the parameter of one of its member functions. Again, the implication is that the source forgets all about this object once the member function returns. The target is not saved in an instance variable.

The **«delegates»** stereotype is not a standard part of UML, it is one of my own. However, I find I use it so often that I thought I'd include it here. I use it when the source class forwards a member function invocation to the target. There are a number of design patterns where this technique is applied, such as PROXY, DECORATOR, and COMPOSITE⁷. Since I use these patterns a lot, I find the notation helpful.

Inner Classes

Inner (nested) classes are represented in UML with an association adorned with a crossed circle.

Anonymous Inner Classes

One of Java's most interesting features is anonymous inner classes. While UML does not have an official stance on these, I find the notation in Figure 3-22 works well for me. It is

7. [GOF94] p207, 175, 163

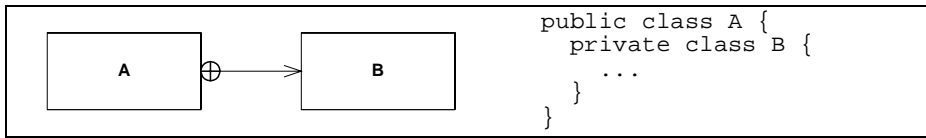

Figure 3-21

concise and descriptive. The anonymous inner class is shown as a nested class that is given the «anonymous» stereotype, and is also given the name of the interface it implements.

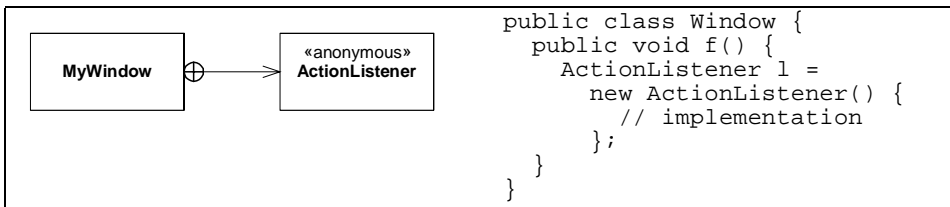

Figure 3-22

Association classes

Associations with multiplicity tell us that the source is connected to many instances of the target; but the diagram doesn't tell us what kind of container class is used. This can be depicted by using an association class as shown in Figure 3-23.

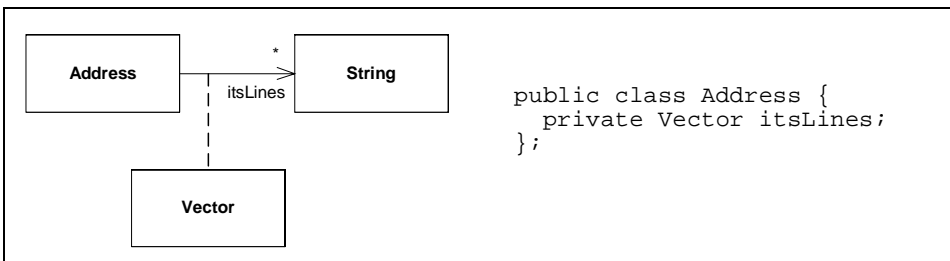

Figure 3-23
Association class.

Association classes show how a particular association is implemented. On the diagram they appear as a normal class connected to the association with a dashed line. As Java programmers we interpret this to mean that the source class really contains a reference to the association class, which in turn contains references to the target.

Association classes can also be used to indicate special forms of references, such as weak, soft, or phantom references. See Figure 3-24.

On the other hand, this notation is a bit cumbersome and is probably better done with stereotypes as in Figure 3-25.

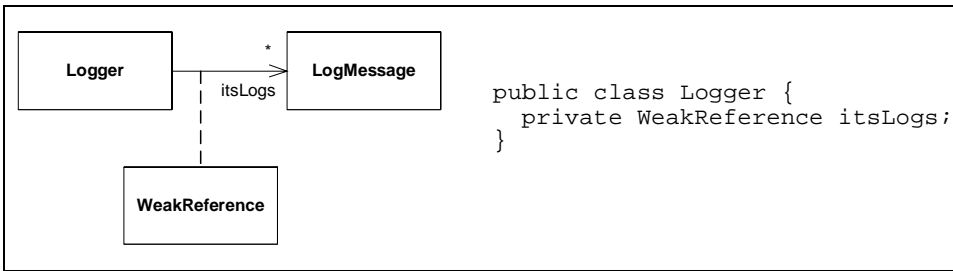

Figure 3-24

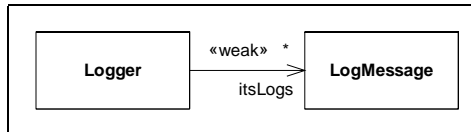

Figure 3-25

Association Qualifiers

Association qualifiers are used when the association is implemented through some kind of key or token, instead of with a normal Java reference. The example in Figure 3-26 shows a LoginServlet associated with an Employee. The association is mediated by a member variable named empid which contains the database key for the Employee.

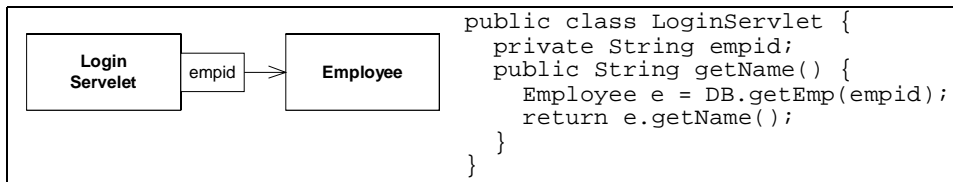

Figure 3-26

I find this notation useful in rare situations. Sometimes it's convenient to show that an object is associated to another through a database or dictionary key. It is important, however, that all the parties reading the diagram know how the qualifier is used to access the actual object. This is not something that's immediately evident from the notation.

Conclusion

There are lots of widgets, adornments, and whatchamajiggers in UML. There are so many that you can spend a long time becoming an UML language lawyer enabling you to do what all lawyers can -- write documents nobody can understand.

In this chapter I have avoided most of the arcanities and byzantine features of UML. Rather I have showed you the parts of UML that *I* use. I hope that along with that knowledge I have instilled within you the values of minimalism. Using too little of UML is almost always better than using too much.

Bibliography

[Booch94]: *Object Oriented Analysis and Design with Applications*, Grady Booch, Benjamin Cummings, 1994

[GOF94]: *Design Patterns*, Gamma, Helm, Vlissides, Johnson, Addison Wesley, 1994.

Sequence Diagrams

Sequence diagrams are the most common of the dynamic models drawn by UML slingers. As you might expect, UML provides lots and lots of goodies to help you draw truly incomprehensible diagrams. In this chapter we'll study those goodies, and try to convince you to use them with great restraint.

I once consulted for a team that had decided to create sequence diagram for every method of every class. No, no, no, no, no! Don't do this, it's a terrible waste of time. Use sequence diagrams when you have an immediate need to describe to someone how a group of objects collaborate, or when you want to visualize that collaboration for yourself. Use them as a tool that you occasionally use to hone your analytical skills, rather than as necessary documentation.

The Basics

I first learned to draw sequence diagrams in 1978. James Grenning, a long time friend and associate, showed them to me while we were working on a project that involved complex communication protocols between computers connected by modems. What I am going to show you here is just a little more complex than what he taught me then; and should suffice for the vast majority of sequence diagrams that you will need to draw.

Objects, Lifelines, Messages, and other odds and ends.

Figure 4-1 shows a typical sequence diagram. The objects involved in the collaboration are shown at the top. The stick figure (actor) at left represents an anonymous object. It is the source and sink of all the messages entering and leaving the collaboration. Not all sequence diagrams have such an anonymous actor, but many do.

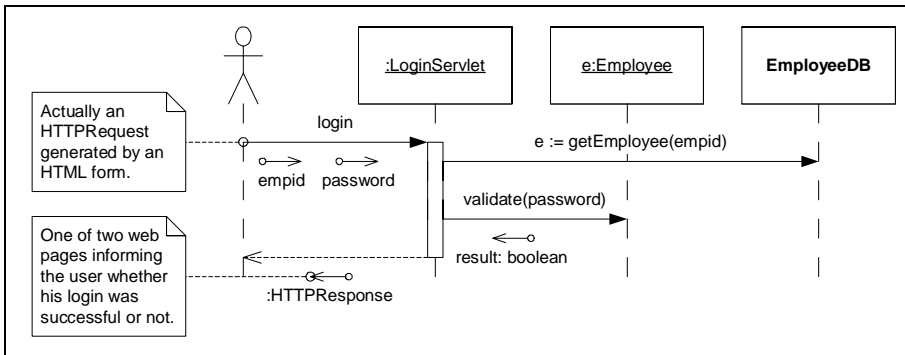

Figure 4-1
Typical Sequence Diagram

The dashed lines hanging down from the objects and the actor are called *lifelines*. A message being sent from one object to another is shown as an arrow between the two lifelines. Each message is labeled with its name. Arguments appear either in the parenthesis that follow the name, or next to *data tokens* (the little arrows with the circles on the end). Time is in the vertical dimension, so the lower a message appears the later it is sent.

The skinny little rectangle on the lifeline of the `LoginServlet` object is called an *activation*. Activations are optional; most diagrams don't need them. They represent the time that a function executes. In this case it shows how long the `login` function runs. The two messages leaving the activation to the right were sent by the `login` method. The unlabeled arrow shows the `login` function returning to the actor, and passing back a return value.

Note the use of the `e` variable in the `getEmployee` message. This signifies the value returned by `getEmployee`. Notice also that the `Employee` object is named `e`. You guessed it, they're one and the same. The value that `getEmployee` returns is a reference to the `Employee` object.

Finally, notice that `EmployeeDB` is a class, not an object. This can only mean that `getEmployee` is a static method. Thus, we'd expect `EmployeeDB` to be coded as in Listing 4-1.

Listing 4-1
`EmployeeDB.java`

```

public class EmployeeDB
{
    public static Employee getEmployee(String empid)
    {
        ...
    }
    ...
}
  
```

Creation and Destruction

We can show the creation of an object on a sequence diagram using the convention shown in Figure 4-2. An unlabeled message terminates on the object to be created, not on its life-line. We would expect ShapeFactory to be implemented as shown in Listing 4-2.

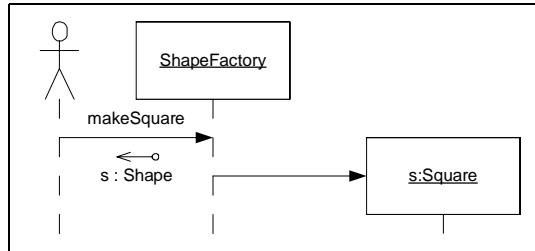

Figure 4-2
Creating an object

Listing 4-2 ShapeFactory.java

```

public class ShapeFactory
{
    public Shape makeSquare()
    {
        return new Square();
    }
}
  
```

In Java we don't explicitly destroy objects. The garbage collector does all the explicit destruction for us. However, there are times when we want to make it clear that we are done with an object and that, as far as we are concerned, the garbage collector can have it.

Figure 4-3 shows how we denote this in UML. The lifeline of the object to be released comes to a premature end at a large X. The message arrow terminating on the X represents the act of releasing the object to the garbage collector.

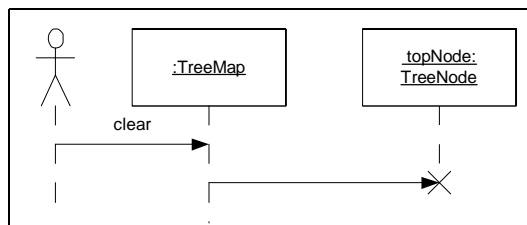

Figure 4-3
Releasing an object to the garbage collector

Listing 4-3 shows the implementation we might expect from this diagram. Notice that the `clear` method sets the `topNode` variable to `nil`. Since the `TreeMap` is the only object that holds a reference to that `TreeNode` instance, it will be released to the garbage collector.

Listing 4-3
TreeMap.java

```
public class TreeMap
{
    private TreeNode topNode;
    public void clear()
    {
        topNode = nil;
    }
}
```

Simple Loops

You can draw a simple loop in a UML diagram by drawing a box around the messages that repeat. The loop condition can appear somewhere in the box, usually at the lower left. See Figure 4-4.

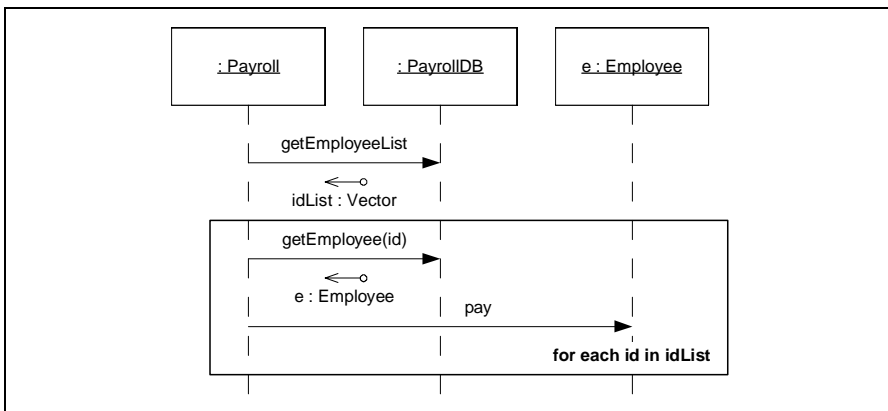

Figure 4-4
A simple loop

This is a useful notational convention. However, it is not wise to try to capture algorithms in sequence diagrams. Sequence diagrams should be used to expose the connections between objects not the nitty gritty details of an algorithm.

Cases and Scenarios

Rule: Don't draw sequence diagrams like Figure 4-5 with lots of objects and scores of messages. Nobody can read them. Nobody will read them. They're a huge waste of time.

Rather, learn how to draw a few smaller sequence diagrams that capture the essence of what you are trying to do. Each sequence diagram should fit on a single page, with plenty of room left for explanatory text. You should not have to shrink the icons down to tiny sizes to get them to fit on the page.

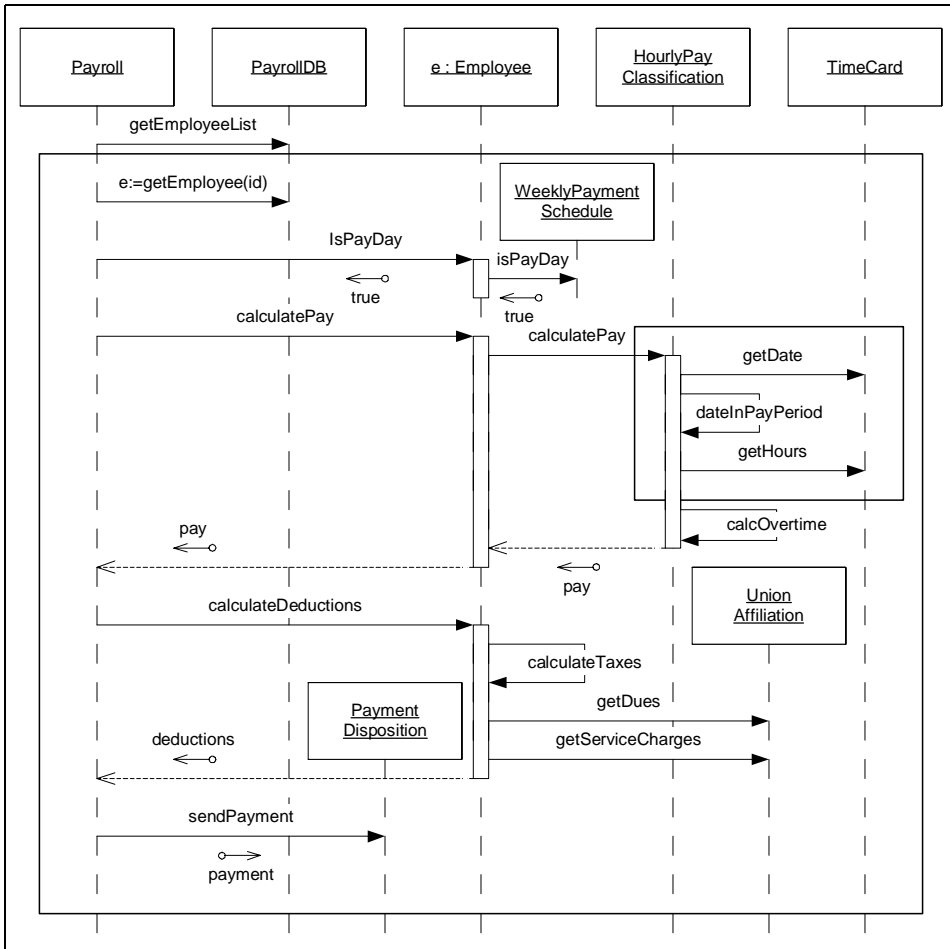

Figure 4-5

This sequence diagram is too complex

Also, don't draw dozens or hundreds of sequence diagrams. If you have too many, they won't be read. Find out what's common about all the scenarios and focus on that. *In the world of UML diagrams, commonalities are much more important than differences.* Use your diagrams to show common themes and common practices. Don't use them to document every little detail. If you really need to draw a sequence diagram to describe the

way messages flow, then do them succinctly, and sparingly. Draw as few of them as possible.

First of all, ask yourself if the sequence diagram is necessary at all. Code is often more communicative and economical. Listing 4-4, for example, shows what the code for the `Payroll` class might look like. This code is very expressive, and stands on its own. We don't need the sequence diagram to understand it. So perhaps there's no need to draw the sequence diagram. Perhaps the code is good enough to stand on its own. When code can stand on its own, then diagrams are redundant and wasteful.

Listing 4-4
Payroll.Java

```
public class Payroll
{
    private PayrollDB itsPayrollDB;
    private PayrollDisposition itsDisposition;
    public void doPayroll()
    {
        List employeeList = itsPayrollDB.getEmployeeList();
        for (Iterator iterator = employeeList.iterator();
            iterator.hasNext();)
        {
            String id = (String) iterator.next();
            Employee e = itsPayrollDB.getEmployee(id);
            if (e.isPayDay())
            {
                double pay = e.calculatePay();
                double deductions = e.calculateDeductions();
                itsDisposition.sendPayment(pay - deductions);
            }
        }
    }
}
```

Can code really be used to describe part of a system? In fact, this should be a goal of the developers and designers. The team should strive to create code that is expressive and readable. The more the code can describe itself, the fewer diagrams you will need, and the better of the whole project will be.

Secondly, if you feel a sequence diagram is necessary, ask yourself if there is a way to split it up into a small group of scenarios. For example, we could break the large sequence diagram in Figure 4-5 into several much smaller sequence diagrams that would be much easier to read. Consider how much easier the small scenario in Figure 4-6 is to understand.

Thirdly, think about what you are trying to depict. Are you trying to show the details of a low level operation like Figure 4-6 shows how to calculate hourly pay? Or are you trying to show a high level view of the overall flow of the system as in Figure 4-7? In general, high level diagrams are more useful than low level ones. They help the reader tie the system together in his mind. They expose commonalities more than differences.

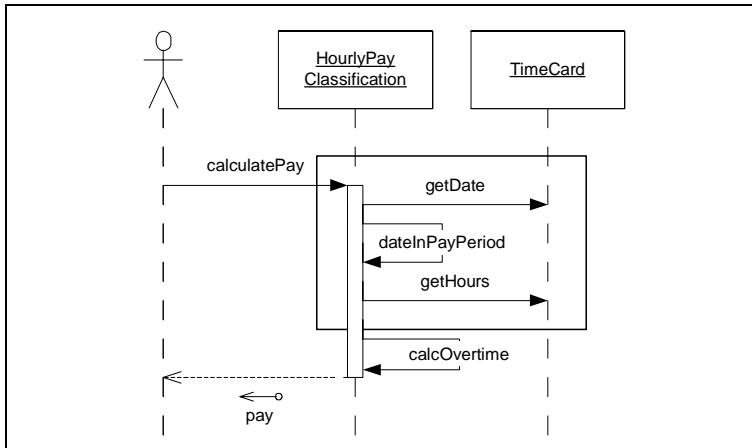

Figure 4-6
One small scenario

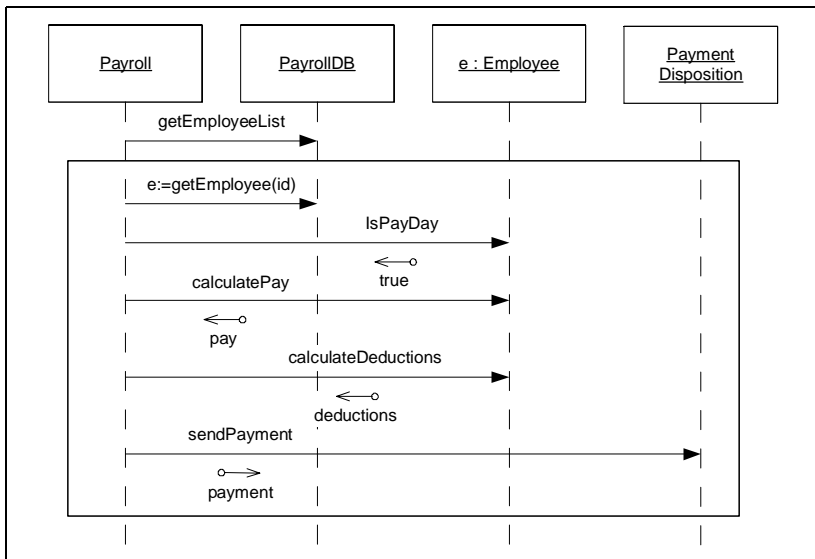

Figure 4-7
A high level view.

Advanced Concepts

Loops and Conditions

It is possible to draw a sequence diagram that completely specifies an algorithm. In Figure 4-8 you can see the payroll algorithm, complete with well specified loops and if statements.

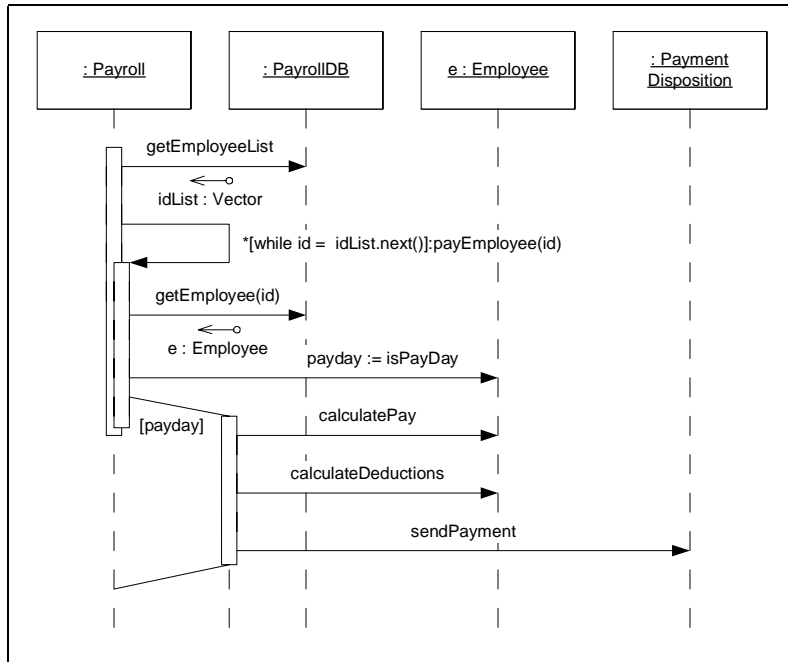

Figure 4-8

The `payEmployee` message is prefixed with an *recurrence* expression that looks like this:

```
*[while id := idList.next()]
```

The star tells us that this is an iteration; the message will be sent repeatedly until the *guard* expression in the square brackets is false. UML does not specify a syntax for the guard expression so I have used a java-like pseudo code that suggests the use of an iterator.

The `payEmployee` message terminates on an activation that is touching, but offset from, the first. This denotes that there are now two functions executing in the same object. Since the `payEmployee` message is recurrent, the second activation will also be recurrent, and so all the messages depending from it will be part of the loop.

Note the activation that is near the [payday] guard. This denotes an `if` statement. The second activation only gets control if the guard condition is true. Thus, if `isPayDay` returns `true`, then `calculatePay`, `calculateDeductions`, and `sendPayment` will be executed. Otherwise they won't.

The fact that it is possible to capture all the details of an algorithm in a sequence diagram should not be construed as a license to capture all your algorithms in this manner. The depiction of algorithms in UML is clunky at best. The code in Listing 4-4 is a *much* better way of expressing the algorithm.

Messages that take time.

Usually we don't consider the time it takes to send a message from one object to another. In most OO languages that time is virtually instantaneous. That's why we draw the message lines horizontally -- they don't take any time. However, in some cases messages *do* take time to send. We could be trying to send a message across a network boundary, or in a system where the thread of control can break between the sending and reception of a message. When this is possible, we can denote it by using angled lines as shown in Figure 4-9

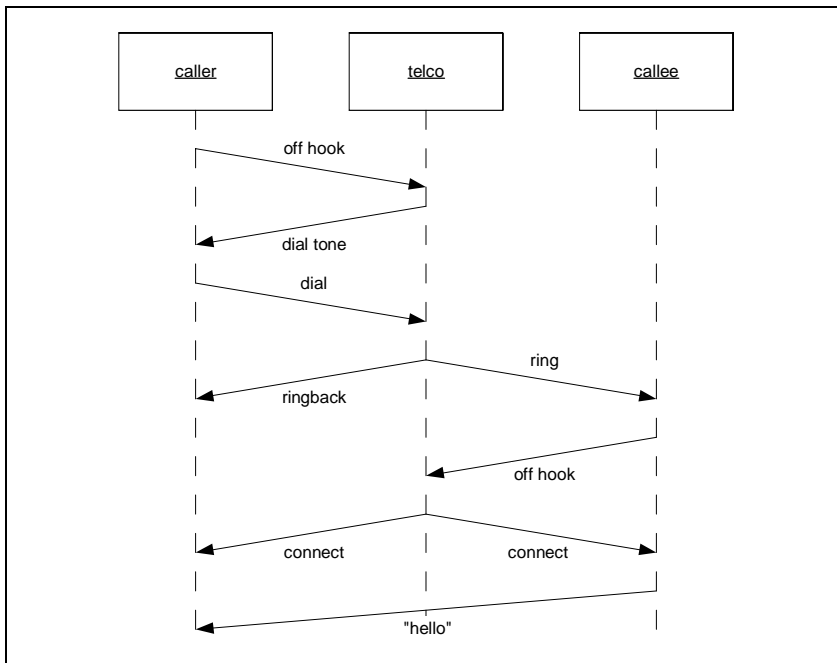

Figure 4-9
Normal Phone Call

This figure shows a phone call being made. There are three objects in this sequence diagram. The `caller` is the person making the call. The `callee` is the person being called. The `telco` is the telephone company.

When the caller lifts the phone from the receiver it send the off hook message to the telco. The telco responds with dial tone. Having recieved dial tone the caller dials the phone number of the callee. The telco responds by ringing the callee and playing ringback tone to the caller. The callee picks up the phone in response to the ring. The telco makes the connection. The callee says “Hello”, and the phone call has succeeded.

However, there is another possibility that demonstrates the usefulness of these kinds of diagrams. Look carefully at the diagram in Figure 4-10. Note that it starts exactly the same. However, just before the callee’s phone rings, he picks it up to make a call himself. The caller is now connected to the callee, but neither know it. The caller is waiting for “Hello”, and the callee is waiting for dial tone. The callee eventually hangs up in frustration, and the caller hears dial tone.

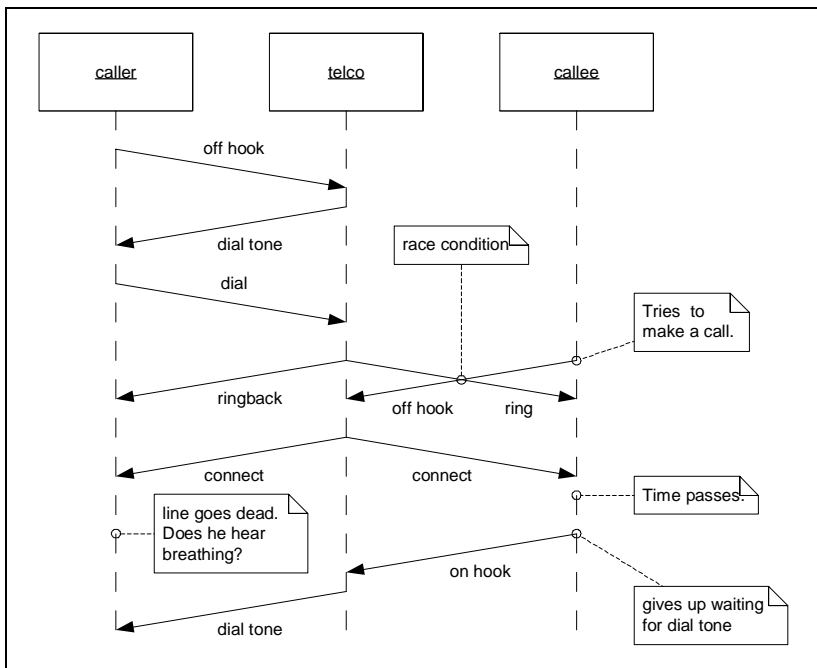

Figure 4-10
Failed Phone Call.

The crossing of the two arrows in Figure 4-10 is called a *race condition*. Race conditions occur when two asynchronous entities can simultaneously invoke incompatible operations. In our case the telco invoked ring, and the callee went off hook. At this point the parties all had a different notion of the state of the system. The caller thought he was wait-

ing for “Hello.”, the telco thought its job was done, and the callee thought he was waiting for dial tone.

Race conditions in software systems can be remarkably difficult to discover and debug. These diagrams can be helpful in finding and diagnosing them. Mostly they are useful in explaining them to others, once discovered.

Asynchronous Messages.

Usually, when you send a message to an object you don’t expect to get control back until the receiving object has finished executing. Messages that behave this way are called *synchronous messages*. However, in distributed or multi-threaded systems it is possible for the sending object to get control back immediately, and for the receiving object to execute in another thread of control. Such messages are called *asynchronous messages*.

Figure 4-11 shows an asynchronous message. Note that the arrowhead is open instead of filled. Look back at all the other sequence diagrams in this chapter. They were all drawn with synchronous (filled arrowhead) messages. It is the elegance (or perversity, take your pick) of UML that such a subtle difference in the arrowhead can have such a profound difference in the represented behavior.

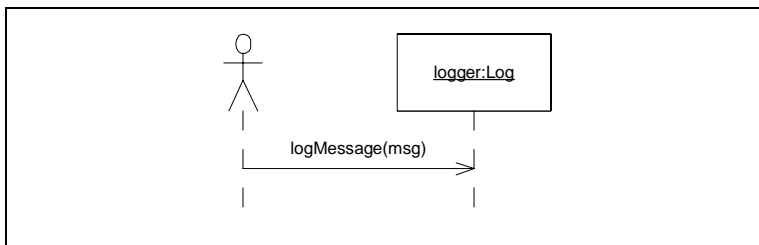

Figure 4-11
Asynchronous Message

Listing 4-5 and Listing 4-6 show code that could correspond to Figure 4-11. Listing 4-5 shows a unit test for the Log class in Listing 4-6. Note that the `logMessage` function returns immediately after queuing the message. Note also that the message is actually processed in a completely different thread that is started by the constructor. The `LogTest` class makes sure that the `logMessage` method behaves asynchronously by first checking to see if the message was logged but not processed, then yielding the processor to other threads, and finally by verifying that the message was processed and removed from the queue.

Listing 4-5 TestLog.java

```

import junit.framework.TestCase;
import junit.swingui.TestRunner;

public class TestLog extends TestCase {
  
```

Listing 4-5 (Continued)**TestLog.java**

```

public static void main(String[] args) {
    TestRunner.main(new String[]{"TestLog"});
}

public TestLog(String name) {
    super(name);
}

public void testSend() throws Exception {
    Log l = new Log(System.out);
    l.logMessage("the message");
    assertEquals(1, l.messages());
    assertEquals(0, l.logged());
    Thread.yield();
    assertEquals(1, l.logged());
    assertEquals(0, l.messages());
    l.stop();
}
}

```

Listing 4-6**Log.java**

```

import java.util.Vector;
import java.io.PrintStream;

public class Log {
    private Vector messages = new Vector();
    private Thread t;
    private boolean running = false;
    private int logged = 0;
    PrintStream logStream;

    public Log(PrintStream stream) {
        logStream = stream;
        running = true;
        t = new Thread(
            new Runnable() {
                public void run() {
                    while (running) {
                        if (messages() > 0) {
                            String msg;
                            synchronized (messages) {
                                msg = (String) messages.remove(0);
                            }
                            logStream.println(msg);
                            logged++;
                        }
                    }
                }
            }
        );
        t.start();
    }

    public void logMessage(String msg) {

```

Listing 4-6 (Continued)
Log.java

```

    synchronized (messages) {
        messages.add(msg);
    }
}

public int messages() {
    return messages.size();
}

public int logged() {
    return logged;
}

public void stop() throws InterruptedException {
    running = false;
    t.join();
}
}

```

This is just one possible implementation of an asynchronous message. Other implementations are possible. In general, we denote a message to be asynchronous if the caller can expect it to return before the desired operations are performed.

Multiple Threads

Asynchronous messages imply multiple threads of control. We can show several different threads of control in a UML diagram by tagging the message name with a thread identifier as shown in Figure 4-12.

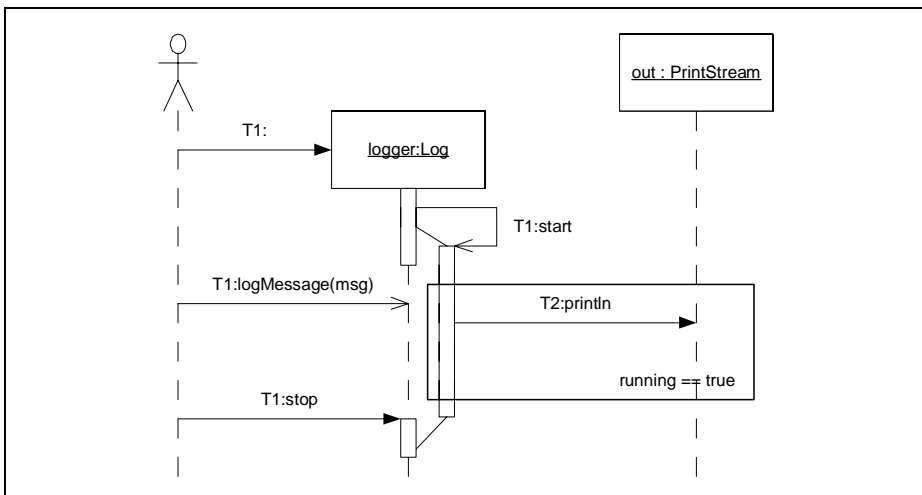

Figure 4-12
 Multiple Threads of Control

Notice that the name of the message is prefixed with an identifier such as T1, followed by a colon. This identifier names the thread that the messages was sent from. In the diagram, the `Log` object was created and manipulated by thread T1. The thread that actually does the message logging, running inside the `Log` object, is named T2.

As you can see, the thread identifiers don't necessarily correspond to names in the code. Listing 4-6 above does not name the logging thread T2. Rather, the thread identifiers are for the benefit of the diagram.

Active Objects

Sometimes we want to denote that an object has a separate internal thread. Such objects are known as *active objects*. They are shown with a bold outline as in Figure 4-13.

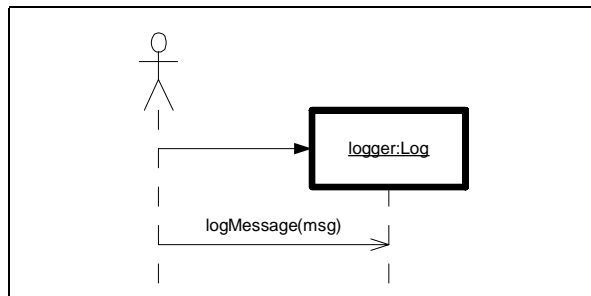

Figure 4-13
Active Object

Active objects simply objects that instantiate and control their own thread. There are no restrictions about their methods. Their methods may run in the object's thread, or they may run in the caller's thread.

Sending Messages to Interfaces.

Our `Log` class is just one way to log messages. What if we wanted our application to be able to use many different kinds of loggers. We'd probably create a `Logger` interface that declared the `logMessage` method, and derive our `Log` class, and all the other implementations from that interface. See Figure 4-14.

The application is going to be sending messages to the `Logger` interface. It won't know that the object is an `AsynchronousLogger`. How can we depict this in a sequence diagram?

The diagram in Figure 4-15 is the obvious approach. You just name the object for the interface and be done with it. This may seem to break the rules since it's impossible to have an instance of an interface. However, all we are saying here is that the `logger` object

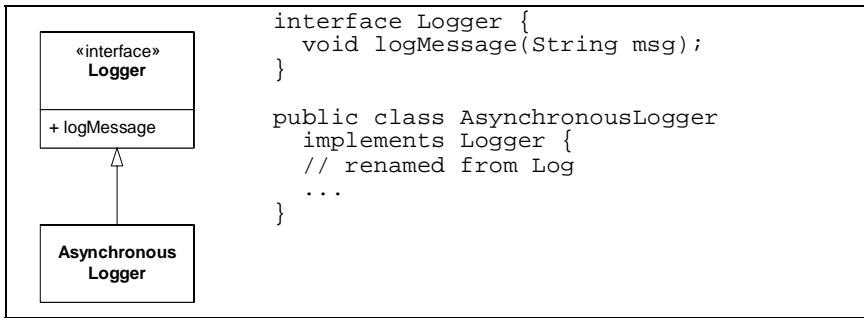
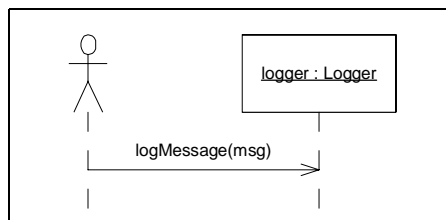

Figure 4-14

Figure 4-15
Sending to an interface

conforms to the `Logger` type. We aren't saying that we somehow managed to instantiate an interface.

Sometimes, however, know the type of the object and yet want to show the message being sent to an interface. For example, we might know that we have created an `AsynchronousLogger`, but we still want to show the application using only the `Logger` interface. Figure 4-16 shows how this is depicted. We use the interface lollipop on the lifeline of the object.

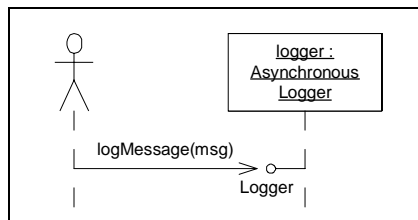

Figure 4-16

Conclusion

As we have seen, sequence diagrams are a powerful way to communicate the flow of messages in an object oriented application. We've also hinted that the fact that they are easy to abuse, and easy to overdo.

An occasional sequence diagram on the whiteboard can be invaluable. A very short paper with five or six sequence diagrams denoting the most common interactions in a subsystem can be worth its weight in gold. On the other hand, a document filled with a thousand sequence diagrams is not likely to be worth the paper it's printed on.

One of the great fallacies of software development in the 1990s was the notion that developers should draw sequence diagrams for all methods *before* writing the code. This always proves to be a very expensive waste of time. Don't do it.

Instead, use sequence diagrams as the tool they were intended to be. Use them at a whiteboard to communicate with others in real time. Use them in a document to capture the core salient collaborations of the system.

As far as sequence diagrams are concerned, too few is better than too many. You can always draw one later if you find you need it.

5

Use Cases

Use cases are a wonderful idea that has been vastly overcomplicated. Over and over again I have seen teams sitting and spinning in their attempts to write use cases. Typically they thrash on issues of form rather than substance. They argue and debate over preconditions, postconditions, actors, secondary actors, and a whole bevy of other things that just don't matter.

The real trick to doing use cases is to *keep them simple*. Don't worry about use case forms, just write them on *blank* paper, or on a *blank* page in a simple word processor, or on *blank* index cards. Don't worry about filling in all the details. Details aren't important until much latter. Don't worry about capturing *all* the use cases, that's an impossible task anyway.

The one thing to remember about use cases is: *tomorrow they are going to change*. No matter how dilligently you capture them, no matter how fastidiously you record the details, no matter how thoroughly you think them through, no matter how much effort you apply to exploring and analyzing the requirements, *tomorrow* they are going to change.

If something is going to change tomorrow, you don't really need to capture its details today. Indeed, you want to postpone the capture of the details until the very last possible moment.

Think of use cases as: *Just In Time Requirements*.

Writing Use Cases

Notice the title of this section. We *write* use cases, we don't draw them. Use cases are not diagrams. Use cases are textual descriptions of behavioral requirements; written from a certain point of view.

“Wait!”, you say. “I know UML has use case diagrams, I’ve seen them.”

Yes, UML does have use case diagrams, and we’ll study them in a few pages. However, those diagrams tell you nothing at all about the content of the use cases. They are devoid of information regarding the behavioral requirements that use cases are meant to capture. Use case diagrams in UML capture something else entirely. And we’ll discuss them in due course.

What is a use case.

A use case is a description of the behavior of a system. That description is written from the point of view of a user who has just told the system to do something particular. A use case captures the *visible* sequence of events that a system goes through in response to a *single* user stimulus.

A visible event is an event that the user can see. Use cases do not describe hidden behavior at all. They don’t discuss the hidden mechanisms of the system. They only describe those things that a user can see.

The Primary Course

Typically, a use case is broken up into two sections. The first is the primary course. This section describes how the system responds to the stimulus of the user and assumes that nothing goes wrong.

For example, here is a typical use case for a point of sale system:

Check Out Item:

- 1. Cashier swipes product over scanner, scanner reads UPC code.*
- 2. Price and description of item, as well as current subtotal appear on the display facing the customer. The price and description also appear on the cashier’s screen.*
- 3. Price and description are printed on receipt.*
- 4. System emits an audible “acknowledgement” tone to tell the cashier that the UPC code was correctly read.*

That’s the primary course of a use case! Nothing more complex is necessary. Indeed, even the tiny sequence above might be too much detail if the use case isn’t going to be implemented for awhile. We wouldn’t want to record this kind of detail until the use cases was within a few weeks of being implemented.

How can you estimate a use case if you don’t record it’s detail? You talk to the stakeholders about the detail, without necessarily recording it. This will give you the information you need to give a rough estimate. Why not record the detail if we’re going to talk to the stakeholders about it? Because tomorrow the details are going to change. Won’t that

chnage affect the estimate? Yes, but over many use cases those effects integrate out. Recording the detail too early just isn't cost effective.

If we aren't going to record the details of the use case just yet, then what *do* we record? How do we know that the use case even exists if we don't write something down? Write the name of the use case. Keep a list of them in a spreadsheet, or a word processor document. Better yet, write the name of the use case on an index card and maintain a stack of use case cards. Fill in the details as they get closer to implementation.

Alternate Courses

Some of those details are concerning things that can go wrong. During the conversations with the stakeholders you'll want to talk over failure scenarios. Later, it gets closer and closer to the time when the use case will be implemented, you'll want to think through more and more of those alternative cases. They become addenda to the primary course of the use case. They can be written as follows:

UPC Code Not Read:

If the scanner fails to capture the UPC code, the system should emit the "reswipe" tone telling the cashier to try again. If after three tries the scanner still does not capture the UPC code, the cashier should enter it manually.

No UPC Code:

If the item does not have a UPC code, the cashier should enter the price manually.

These alternate courses are interesting because they hint at other use cases that the stakeholders might not have identified initially. In this case it is apparently necessary to be able to enter the UPC or price manually.

What else?

What about actors, secondary actors, preconditions, postconditions, etc. etc. What about all that stuff?

Don't worry about it. For the vast majority of the systems you will work on, you won't need to know about all those other things. Should the time come that you need to know more about use cases, then you can read Alistair Cockburn's definitive work on the topic: *Writing Effective Use Cases*, Addison Wesley, 2001. For now, learn to walk before you learn to run. Get used to writing simple use cases as above. As you master them (defined as having successfully used them in a project), you can ever so carefully and parsimoniously adopt some of the more sophisticated techniques. But remember, don't sit and spin.

Use Cases Diagrams

Of all the diagrams in UML, use case diagrams are the most confusing, and the least useful. With the exception of the System Boundary Diagram, which I'll describe in a minute, I recommend that you avoid them entirely.

System Boundary Diagram

Figure 5-1 shows a System Boundary Diagram. The large rectangle is the system boundary. Everything inside the rectangle is part of the system under development. Outside the rectangle we see the *actors* that *act* upon the system. Actors are entities outside the system that provide the stimuli for the system. Typically they are human users. They might also be other systems, or even devices such as real-time clocks.

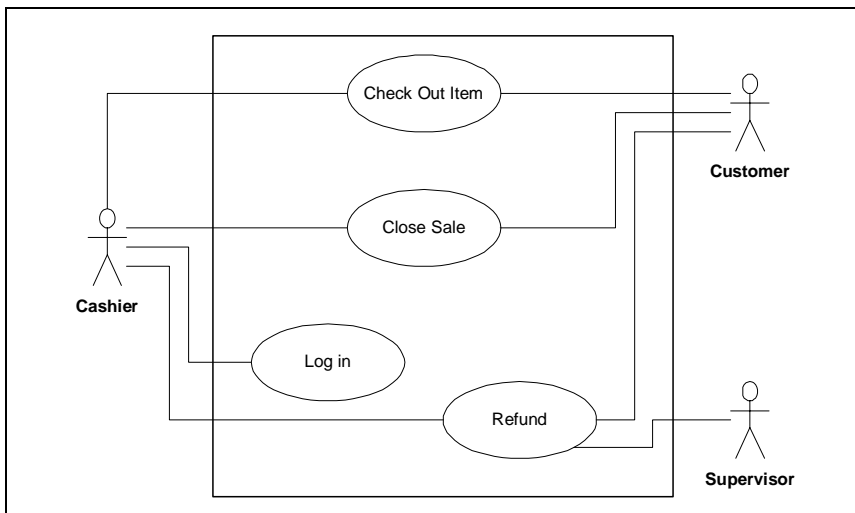

Figure 5-1
System Boundary Diagram

Inside the boundary rectangle we see the use cases. These are the ovals with names inside. The lines connect the actors to the use cases that they stimulate. Avoid using arrows, nobody really knows what the direction of the arrowheads means.

This diagram is almost, but not quite, useless. It contains very little information of use to the Java programmer, but it makes a good cover page for a presentation to stakeholders.

Use Case Relationships

Use case relationships fall into the category of things that “seemed like a good idea at the time”. I suggest that you actively ignore them. They’ll add no value to your use cases, or to your understanding of the system, and they will be the source of many never ending debates about whether or not to use «extends» or «generalization».

Conclusion

This was a short chapter. That’s fitting because the topic is simple. It is that simplicity that must be your attitude concerning use cases. If once you proceed down the dark path of use case complexity, forever will it dominate your destiny. Use the force, Luke, and keep your use cases simple.

Principles of OOD

Reading chapters about notation is like a box of chocolate candy. After eating a few you start to crave meat. So lets dump the sugary notation for awhile and eat a nice, rare chees-burger.

When we look at a UML diagram, what are we looking for? How do we evaluate it? What are the principles of design that we should apply? In this chapter we will discuss five such principles that will help us evaluate whether a set of UML diagrams, or a batch of code, for that matter, are well designed.

Design Quality

What does it mean to be well designed? A system that is well designed is easy to understand, easy to change, and easy to reuse. It presents no particular development difficulties, is simple, terse, and economical. It is a pleasure to work with. Conversely, a bad design stinks like rotting meat.

Design Smells.

You know when a programmer is working with a poor design by the state of his eyes and nose while he's looking at the code. If his or her facial expression reminds you of the detectives who have just opened a body bag containing a 12 day old corpse, then the design is probably pretty ripe. The smells of a poor design have many different components.

1. **Rigidity:** The system is hard to change because every time you change one thing, you have to change something else in a never ending succession of changes.

2. **Fragility:** A change to one part of the system causes it to break in many other, completely unrelated, parts.
3. **Immobility:** It is hard to disentangle the system into components that can be reused in other systems.
4. **Viscosity:** The development environment is held together with scotch tape and toothpaste. It takes forever to go around the edit, compile, test loop.
5. **Needless Complexity:** There are lots of very clever code structures that aren't actually necessary right now, but could be very useful one day.
6. **Needless Repetition:** The code looks like it was written by two programmers named Cut and Paste.
7. **Opacity:** Elucidation of the originator's intent presents certain difficulties related to convolution of expression.

It is our desire to rid the code of these smells. UML diagrams can often help with this because many of the smells can be seen by examining the dependencies in the diagrams.

Dependency Management

Many of these smells are a result of mismanaged dependencies. Mismanaged dependencies conjure the view of code that is a tangled mass of couplings. Indeed, it is this view of entanglement that was the origin of the term "spaghetti code".

Object oriented languages provide tools that aid in managing dependencies. Interfaces can be created that break or invert the direction of certain dependencies. Polymorphism allows modules to invoke functions without depending upon the modules that contain them. Indeed, an OOPL gives us lots of power to shape the dependencies the way we want.

So, how do we want them shaped? That's where the following principles come in. I have written a great deal about these principles. The definitive (and most long-winded) treatment is [Martin2002]. There are also quite a number of papers describing these principles on www.objectmentor.com. What follows is a very brief summary.

The Single Responsibility Principle (SRP)

A CLASS SHOULD HAVE ONLY ONE REASON TO CHANGE.

You've probably read the nonsense about objects needing to know how to draw themselves in a GUI, or save themselves to disk, or convert themselves to XML, right? Beginning OO texts like to say things like that. Ridiculous! Classes should know about only one thing. They should have a single responsibility. More to the point, there should only be one reason for a class to change.

Consider Figure 6-1. This class knows way too much. It knows how to calculate pay and taxes, how to read and write itself on disk, how to convert itself to XML and back, and how to print itself on various reports. Can you smell the **Fragility**? Change from SAX to JDOM and you have to change `Employee`. Change from Access to Oracle, and you have to change `Employee`. Change the format of the tax report and you have to change `Employee`. This design is badly coupled.

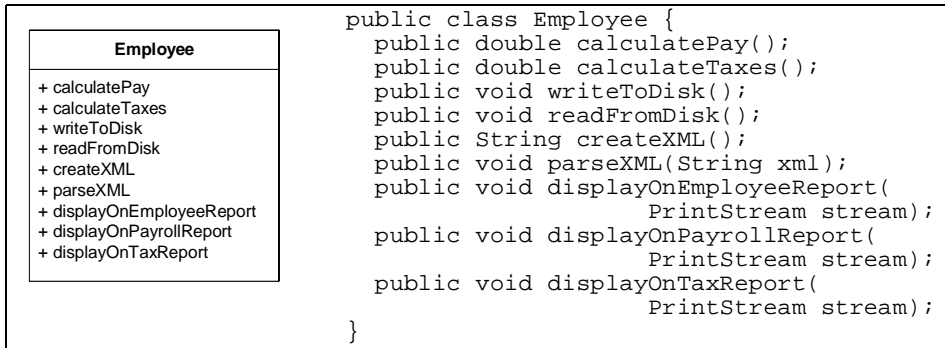

Figure 6-1
Class knows too many things.

In reality we want to separate all these concepts into their own classes so that each class has one, and only one, reason to change. We'd like the `Employee` class to deal with pay and taxes, an XML related class to deal with converting `Employee` instances to and from XML, an `EmployeeDatabase` class to deal with reading and writing `Employee` instances to and from the database, and individual classes for each of the various reports. In short, we want a separation of concerns. A potential structure is shown in Figure 6-2

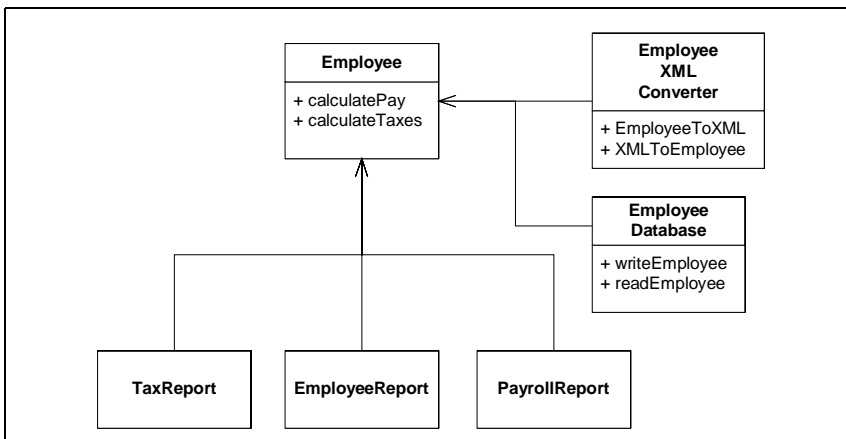

Figure 6-2
Separation of concerns.

Violation of this principle is pretty easy to spot in a UML diagram. Look for classes that have dependencies on more than one topic area. A dead give-away is a class that implements one or more interfaces that endow it with certain properties. Careless use of an interface that endows an object with the ability to be stored on disk, for example, can lead to classes that couple business rules with issues of persistence.

Consider the two diagrams in Figure 6-3. The one on the left couples `Persistable` tightly into `Employee`. All users of `Employee` will transitively depend upon `Persistable`. This dependence may not be great, but it will be there. Changes to the `Persistable` interface will have the potential of affecting all users of `Employee`.

The diagram on the right side of Figure 6-3 leaves `Employee` independent of `Persistable`, and yet allows for persistence just the same. Instances of `PersistableEmployee` can be passed around the system as `Employees`, without the rest of the system knowing about the coupling. The coupling exists, but is hidden to most of the system.

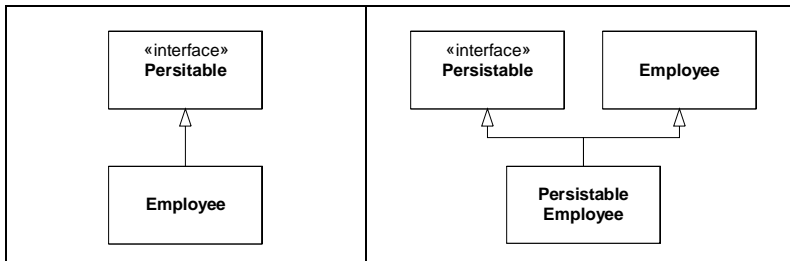

Figure 6-3
Two ways to use Serializable

The Open Closed Principle (OCP)

*SOFTWARE ENTITIES (CLASSES, MODULES, FUNCTIONS, ETC.)
SHOULD BE OPEN FOR EXTENSION, BUT CLOSED FOR MODIFICATION.*

This principle has a high-falutin' definition, but a simple meaning: You should be able to change the environment surrounding a module without changing the module itself.

Consider, for example, Figure 6-4. It shows a simple application that deals with `Employee` objects through a database facade named `EmployeeDB`. The facade deals directly with API of the database. This violates the OCP because a change to the implementation of the `EmployeeDB` class can force a rebuild of the `Employee` class. The `Employee` is transitively bound to the database API. Any system that contains the `Employee` class must also contain `TheDatabase` API.

Unit tests are often the places where we want to make controlled changes to the environment. Consider, for example, how we would test `Employee`. `Employee` objects make

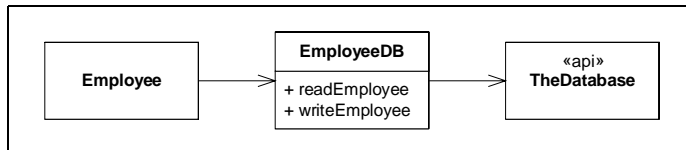

Figure 6-4
Violation of OCP

changes to the database. In a test environment we don't want the real database to change. We also don't want to create dummy databases just for the purposes of unit testing. Instead, we'd like to change the environment so that the test catches all the calls that `Employee` makes to the database, and verifies that those calls are made correctly.

We can do this by converting `EmployeeDB` to an interface as in Figure 6-5. Then we can create derivatives that either invoke the true database API, or that support our tests. The interface separates `Employee` from the database API, and allows us the change the database environment that surrounds `Employee` without affecting `Employee` at all.

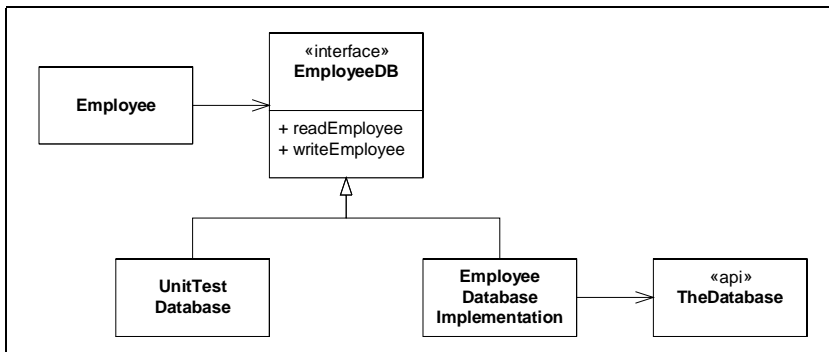

Figure 6-5
Conforming to the OCP

Among the systems that are plagued by violations of OCP are GUIs. Despite the fact that MODEL-VIEW-CONTROLLER has been known for nearly three decades, we often can't seem to get the design of GUI systems right. All too often the code that manipulates the GUI API is inextricably bound to the code that manages and manipulates the data being displayed.

Consider, for example, a very simple dialog box that displays a list of employees. The user selects an employee from the list and then clicks the "Terminate" button. We expect that if no employee is selected, then the "Terminate" button is disabled. On the other hand, if we select an employee from the list, the "Terminate" button will be enabled. When the user clicks the "Terminate" button, the terminated employee disappears from the list, none of the remaining employees is shown as selected, and the terminate button is disabled.

Implementations that violate the OCP would put all this behavior in the class that invokes the calls to the GUI API. OCP compliant systems would separate the manipulation of the GUI from the manipulation of the data.

Figure 6-6 shows the structure of an OCP compliant system. The `EmployeeTerminatorModel` manages the list of employees, and is informed when the user selects or terminates an employee. The `EmployeeTerminatorDialog` manages the GUI. It is given the list of employees to display, and informs its controller when a selection changes or when the terminate button is pressed.

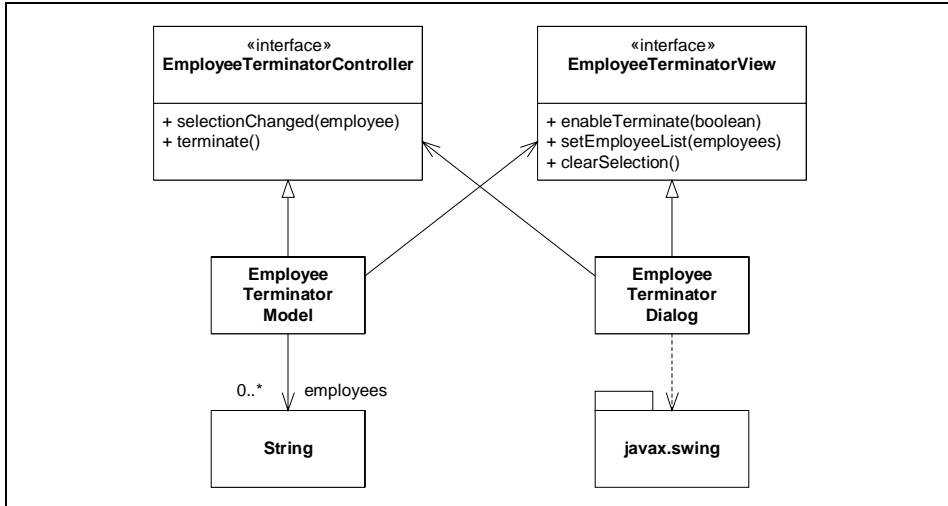

Figure 6-6
Isolating GUI from Data Manipulation

The `EmployeeTerminatorModel` is responsible for actually deleting the selected employee from the list. It is also responsible for determining whether or not the terminate control is enabled or disabled. It doesn't know that this control is implemented with a button. It simply tells its associated view whether or not the user is allowed to terminate. Similarly, even though the model doesn't know anything about a listbox, it can tell its view to clear the selection.

The `EmployeeTerminatorDialog` is brainless. It makes no decisions on its own, and manages no data. The `EmployeeTerminatorModel` pulls its strings, and the dialog reacts. If the user interacts with the dialog, it simply tells its controller what's going on by calling methods on the `EmployeeTerminatorController` interface. These messages are passed to the model which then interprets and acts upon them¹.

1. Readers who know MVC will recognize this as a variation. In more complex situations the controller would be a true object rather than just being an interface for the model. In this case, however, the application is so simple that the controller simply acts as a pass through to the model.

The Java implementation of this structure is shown in Listing 6-1 through Listing 6-4. The two interfaces don't hold any surprises. One might ask why `terminate` and `selectionChanged` are separate functions of `EmployeeTerminatorController`. Why not just have `terminate` take the employee argument? I did this because I didn't want the `EmployeeTerminatorDialog` making assumptions about what it means when the user clicks the terminate button.

Listing 6-1
EmployeeTerminatorView.java

```
import java.util.Vector;

public interface EmployeeTerminatorView {
    void enableTerminate(boolean enable);
    void setEmployeeList(Vector employees);
    void clearSelection();
}
```

Listing 6-2
EmployeeTerminatorController.java

```
public interface EmployeeTerminatorController {
    public void selectionChanged(String employee);
    public void terminate();
}
```

`EmployeeTerminatorModel` is very straightforward. Upon construction it sends the list of employees to the view, clears the selection, and disables the terminate command. When the dialog reports a change in selection by calling `selectionChanged`, then the model appropriately enables the terminate button and saves the selection. When the dialog calls `terminate` then the selected employee is removed from the list, the modified list is sent back to the view, the selection is cleared, and the terminate button is disabled.

Listing 6-3
EmployeeTerminatorModel.java

```
import java.util.Vector;

public class EmployeeTerminatorModel
    implements EmployeeTerminatorController {
    private EmployeeTerminatorView view;
    private Vector employees;
    private String selectedEmployee;

    public void initialize(Vector employees,
        EmployeeTerminatorView view) {
        this.employees = employees;
        this.view = view;
        view.setEmployeeList(employees);
        view.clearSelection();
        view.enableTerminate(false);
    }

    // EmployeeTerminatorController interface
    public void selectionChanged(String employee) {
```

Listing 6-3 (Continued)
EmployeeTerminatorModel.java

```

        view.enableTerminate(employee != null);
        selectedEmployee = employee;
    }

    public void terminate() {
        if (selectedEmployee != null)
            employees.remove(selectedEmployee);
        view.setEmployeeList(employees);
        view.clearSelection();
        view.enableTerminate(false);
    }
}

```

The `EmployeeTerminatorDialog` class is the most complex of the set. Fortunately that complexity is related only to managing the GUI widgets and has nothing to do with the business rules of the system. It simply builds the terminate button and list box, wires them up appropriately and then gets them ready for display. The implementation of the `EmployeeTerminatorView` are all trivial and unsurprising.

Listing 6-4
EmployeeTerminatorDialog.java

```

import javax.swing.*;
import javax.swing.event.ListSelectionEvent;
import javax.swing.event.ListSelectionListener;
import java.awt.*;
import java.awt.event.ActionEvent;
import java.awt.event.ActionListener;
import java.util.Vector;

public class EmployeeTerminatorDialog
    implements EmployeeTerminatorView {
    private JFrame frame;
    private JList listBox;
    private JButton terminateButton;
    private EmployeeTerminatorController controller;
    private Vector employees;

    public static final String
        EMPLOYEE_LIST_NAME = "Employee List";
    public static final String
        TERMINATE_BUTTON_NAME = "Terminate";

    public void
    initialize(EmployeeTerminatorController controller) {
        this.controller = controller;
        initializeEmployeeListBox();
        initializeTerminateButton();
        initializeContentPane();
    }

    private void initializeEmployeeListBox() {
        listBox = new JList();
        listBox.setName(EMPLOYEE_LIST_NAME);
        listBox.addListSelectionListener(

```

Listing 6-4 (Continued)
EmployeeTerminatorDialog.java

```

        new ListSelectionListener() {
            public void valueChanged(ListSelectionEvent e) {
                if (!e.getValueIsAdjusting())
                    controller.selectionChanged(
                        (String) listBox.getSelectedValue());
            }
        }
    );
}

private void initializeTerminateButton() {
    terminateButton = new JButton(TERMINATE_BUTTON_NAME);
    terminateButton.disable();
    terminateButton.setName(TERMINATE_BUTTON_NAME);
    terminateButton.addActionListener(
        new ActionListener() {
            public void actionPerformed(ActionEvent e) {
                controller.terminate();
            }
        }
    );
}

private void initializeContentPane() {
    frame = new JFrame("Employee List");
    frame.getContentPane().setLayout(new FlowLayout());
    frame.getContentPane().add(listBox);
    frame.getContentPane().add(terminateButton);
    frame.getContentPane().setSize(300, 600);
    frame.pack();
}

public Container getContentPane() {
    return frame.getContentPane();
}

public JFrame getFrame() {
    return frame;
}

// functions for EmployeeTerminatorView interface

public void enableTerminate(boolean enable) {
    terminateButton.setEnabled(enable);
}

public void setEmployeeList(Vector employees) {
    this.employees = employees;
    listBox.setListData(employees);
    frame.pack();
}

public void clearSelection() {
    listBox.clearSelection();
}

```

```

Listing 6-4 (Continued)
EmployeeTerminatorDialog.java
    }
}
    
```

The model and dialog objects interact in an interesting way when it comes to selection. The dialog reports all changes in selection to the model by way of the controller interface. This includes changes caused when the model calls `clearSelection`. As you can see in Figure 6-7, when the model calls `clearSelection` on the dialog, the dialog responds by calling `setSelection` on the model.

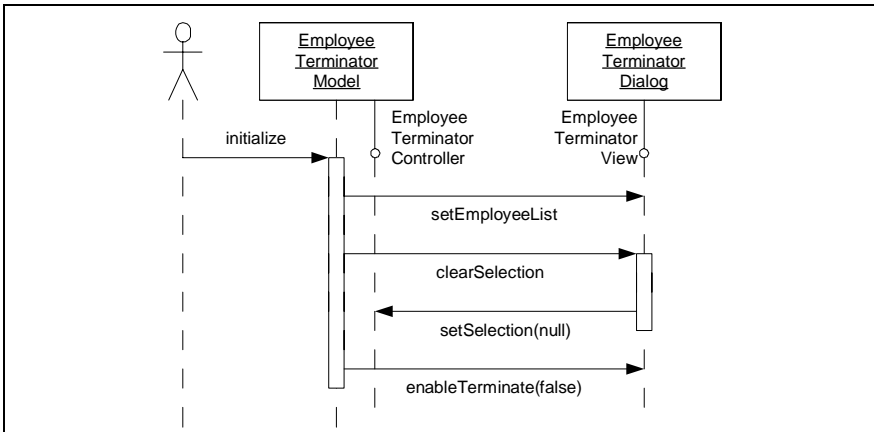

Figure 6-7
Interaction between the Model and Dialog

The conformance to the OCP can be seen most clearly when you look at the unit tests for the model (Listing 6-5) and the dialog (Listing 6-6). These unit tests work without the tested modules knowing about their existence. The `TestEmployeeTerminatorModel` class tests the functionality of the model. The test pretends to be an `EmployeeTerminatorView` and catches the messages that the model sends to the view, checking to be sure that they are called at the correct times and carry the appropriate information. This is known as the SELF SHUNT pattern² for unit testing.

```

Listing 6-5
TestEmployeeTerminatorModel.java
import junit.framework.TestCase;
import junit.swingui.TestRunner;

import java.util.Vector;

public class TestEmployeeTerminatorModel extends TestCase
implements EmployeeTerminatorView {
    private boolean terminateEnabled = true;
    
```

2. [Feathers2001]

Listing 6-5 (Continued)**TestEmployeeTerminatorModel.java**

```
private String selectedEmployee;
private Vector noEmployees = new Vector();
private Vector threeEmployees = new Vector();
private Vector employees = null;
private EmployeeTerminatorModel m;

public static void main(String[] args) {
    TestRunner.main(
        new String[]{"TestEmployeeTerminatorModel"});
}

public TestEmployeeTerminatorModel(String name) {
    super(name);
}

public void setUp() throws Exception {
    m = new EmployeeTerminatorModel();

    threeEmployees.add("Bob");
    threeEmployees.add("Bill");
    threeEmployees.add("Robert");
}

public void tearDown() throws Exception {
}

public void testNoEmployees() throws Exception {
    m.initialize(noEmployees, this);
    assertEquals(0, employees.size());
    assertEquals(false, terminateEnabled);
    assertEquals(null, selectedEmployee);
}

public void testThreeEmployees() throws Exception {
    m.initialize(threeEmployees, this);
    assertEquals(3, employees.size());
    assertEquals(false, terminateEnabled);
    assertEquals(null, selectedEmployee);
}

public void testSelection() throws Exception {
    m.initialize(threeEmployees, this);
    m.selectionChanged("Bob");
    assertEquals(true, terminateEnabled);
    m.selectionChanged(null);
    assertEquals(false, terminateEnabled);
}

public void testTerminate() throws Exception {
    m.initialize(threeEmployees, this);
    assertEquals(3, employees.size());
    selectedEmployee = "Bob";
    m.selectionChanged("Bob");
    m.terminate();
    assertEquals(2, employees.size());
}
```

Listing 6-5 (Continued)
TestEmployeeTerminatorModel.java

```

    assertEquals(null, selectedEmployee);
    assertEquals(false, terminateEnabled);
    assert(employees.contains("Bill"));
    assert(employees.contains("Robert"));
    assert(!employees.contains("Bob"));
}

// EmployeeTerminatorView interface
public void enableTerminate(boolean enable) {
    terminateEnabled = enable;
}

public void setEmployeeList(Vector employees) {
    this.employees = (Vector) employees.clone();
}

public void clearSelection() {
    selectedEmployee = null;
}
}

```

The `TestEmployeeTerminatorDialog` class also uses the SELF-SHUNT pattern, pretending to be a `TestTerminatorController`. It catches the messages sent from the dialog to the controller, and verifies that they are called at the right times and contain the appropriate data. Most of this test just checks the wiring of the dialog box. It checks to make sure that the listbox and button are created properly and that they function as they are supposed to.

Listing 6-6
TestEmployeeTerminatorDialog.java

```

import junit.framework.TestCase;
import junit.swingui.TestRunner;

import javax.swing.*;
import java.awt.*;
import java.util.HashMap;
import java.util.Vector;

public class TestEmployeeTerminatorDialog
    extends TestCase
    implements EmployeeTerminatorController
{
    private EmployeeTerminatorDialog terminator;
    private JList list;
    private JButton button;
    private Container contentPane;
    private String selectedValue = null;
    private int selectionCount = 0;
    private int terminations = 0;

    public static void main(String[] args) {
        TestRunner.main(
            new String[]{"TestEmployeeTerminatorDialog"});
    }
}

```

Listing 6-6 (Continued)
TestEmployeeTerminatorDialog.java

```
public TestEmployeeTerminatorDialog(String name) {
    super(name);
}

public void setUp() throws Exception {
    terminator = new EmployeeTerminatorDialog();
    terminator.initialize(this);
    putComponentsIntoMemberVariables();
}

private void putComponentsIntoMemberVariables() {
    contentPane = terminator.getContentPane();
    HashMap map = new HashMap();
    for (int i = 0; i < contentPane.getComponentCount(); i++) {
        Component c = contentPane.getComponent(i);
        map.put(c.getName(), c);
    }
    list = (JList) map.get(
        EmployeeTerminatorDialog.EMPLOYEE_LIST_NAME);
    button = (JButton) map.get(
        EmployeeTerminatorDialog.TERMINATE_BUTTON_NAME);
}

private void putThreeEmployeesIntoTerminator() {
    Vector v = new Vector();
    v.add("Bob");
    v.add("Bill");
    v.add("Boris");
    terminator.setEmployeeList(v);
}

public void testCreate() throws Exception {
    assertNotNull(contentPane);
    assertEquals(2, contentPane.getComponentCount());
    assertNotNull(list);
    assertNotNull(button);
    assertEquals(false, button.isEnabled());
}

public void testAddOneName() throws Exception {
    Vector v = new Vector();
    v.add("Bob");
    terminator.setEmployeeList(v);
    ListModel m = list.getModel();
    assertEquals(1, m.getSize());
    assertEquals("Bob", m.getElementAt(0));
}

public void testAddManyNames() throws Exception {
    putThreeEmployeesIntoTerminator();
    ListModel m = list.getModel();
    assertEquals(3, m.getSize());
    assertEquals("Bob", m.getElementAt(0));
    assertEquals("Bill", m.getElementAt(1));
    assertEquals("Boris", m.getElementAt(2));
}
```

Listing 6-6 (Continued)**TestEmployeeTerminatorDialog.java**

```

    }

    public void testEnableTerminate() throws Exception {
        terminator.enableTerminate(true);
        assertEquals(true, button.isEnabled());
        terminator.enableTerminate(false);
        assertEquals(false, button.isEnabled());
    }

    public void testClearSelection() throws Exception {
        putThreeEmployeesIntoTerminator();
        list.setSelectedIndex(1);
        assertNotNull(list.getSelectedValue());
        terminator.clearSelection();
        assertEquals(null, list.getSelectedValue());
    }

    public void testSelectionChangedCallback() throws Exception {
        putThreeEmployeesIntoTerminator();
        list.setSelectedIndex(1);
        assertEquals("Bill", selectedValue);
        assertEquals(1, selectionCount);
        list.setSelectedIndex(2);
        assertEquals("Boris", selectedValue);
        assertEquals(2, selectionCount);
    }

    public void testTerminateButtonCallback() throws Exception {
        button.doClick();
        assertEquals(1, terminations);
    }

    // implement EmployeeTerminatorController
    public void selectionChanged(String employee) {
        selectedValue = employee;
        selectionCount++;
    }

    public void terminate() {
        terminations++;
    }
}

```

The tests demonstrate conformance to the OCP because it is possible to change the environment surrounding both the `dialog` and the `model` to a *test environment* without the `dialog` or `model` knowing it. Consider what this means in terms of the flexibility of the modules. We could easily replace the `dialog` with a command line UI, or a text menu UI. The `model` would never know the difference. We can put the `model` and `dialog` on different machines using RMI. We can change the environment of each module without affecting the other.

It's easy to see the mechanism of OCP conformance. Look again at Figure 6-6. We see the familiar FLIP-FLOP pattern³ of modules implementing one interface and communi-

cating with another. Clearly we are free to change the environment surrounding the modules because of their use of abstract interfaces. Indeed, abstraction is the key to OCP conformance.

How do we identify the abstractions that help us to conform to the OCP? Most often I achieve OCP compliance simply by writing the unit tests before I write the actual code. Both of the preceding unit tests were written using the *test-first* method. Each of the test functions were written first, followed by just enough code in the module to make the test function pass.

For the sake of completeness, Listing 6-7 shows code that binds the dialog and model together and displays the dialog I used this module as a final, manual, test. It allowed me to verify the (admittedly sparse) look and feel of the dialog. This is the only code I wrote that actually displays the dialog. The dialog unit test above simply checks the wiring and function of the dialog, and does not actually display it.

Listing 6-7

ShowEmployeeTerminator.java

```
import java.awt.event.WindowAdapter;
import java.awt.event.WindowEvent;
import java.util.Vector;

public class ShowEmployeeTerminator {
    static Vector employees = new Vector();
    static EmployeeTerminatorDialog dialog;

    public static void main(String[] args) {
        initializeEmployeeVector();
        initializeDialog();
        runDialog();
    }

    private static void initializeEmployeeVector() {
        employees.add("Bob");
        employees.add("Bill");
        employees.add("Robert");
    }

    private static void initializeDialog() {
        EmployeeTerminatorModel model = new
EmployeeTerminatorModel();
        dialog = new EmployeeTerminatorDialog();
        dialog.initialize(model);
        model.initialize(employees, dialog);
    }

    private static void runDialog() {
        dialog.getFrame().addWindowListener(
            new WindowAdapter() {
                public void windowClosing(WindowEvent e) {
                    for (int i = 0; i < employees.size(); i++) {
```

3. So named because of its resemblance to the circuit diagram of an Eccles-Jordan flip-flop. I know of no written description of this pattern, yet I run into it all the time.

Listing 6-7 (Continued)
ShowEmployeeTerminator.java

```

        String s = (String) employees.elementAt(i);
        System.out.println(s);
    }
    System.exit(0);
}
}
);
dialog.getFrame().setVisible(true);
}
}
}

```

The Liskov Substitution Principle (LSP)

SUBTYPES MUST BE SUBSTITUTABLE FOR THEIR BASE TYPES.

Have you ever seen code that has lots of `instanceof` expressions in the clauses of `if` statements. Though there are some legitimate uses for expressions like this, they are few and far between. Usually they are a result of violating the LSP, and are themselves a violation of the OCP.

The LSP says that the users of base classes should not have to do anything special in order to use derivatives. Specifically, they should not have to use `instanceof`, or downcasts. Indeed, they should know nothing about the derivatives at all. Not even that they exist.

Consider the payroll application shown in Figure 6-8. The `Employee` class is abstract and has an abstract method named `calcPay`. It's pretty clear that `SalariedEmployee` will implement this to return the employee's salary. It's also pretty clear that `HourlyEmployee` will implement it to return the hourly rate times the sum of the hours on this week's time cards.

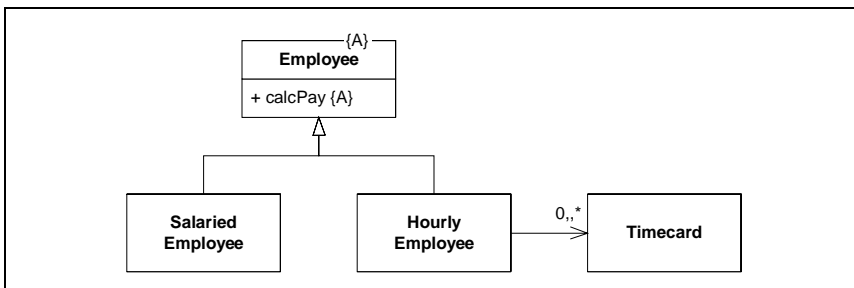

Figure 6-8
Simple Payroll Example

What would happen if we decided to add a `VolunteerEmployee`? How would we implement `calcPay`? At first this may seem obvious. We'd implement `calcPay` to return zero as shown below.

```
public class VolunteerEmployee extends Employee {
    public double calcPay() {
        return 0;
    }
}
```

But is this right? Does it make any sense to even *call* `calcPay` on a `VolunteerEmployee`? After all, by returning zero we are implying that `calcPay` is a reasonable function to call, and payment is possible. We might find ourselves in the embarrassing situation of printing and mailing a paycheck with a gross pay of zero, or some other similar non-sequitur.

So maybe the best thing to do is to throw an exception, indicating that this function really shouldn't have been called.

```
public class VolunteerEmployee extends Employee {
    public double calcPay() {
        throw new UnpayableEmployeeException();
    }
}
```

At first this seems like a reasonable thing to do. After all, it's *illegal* to call `calcPay` on a `VolunteerEmployee`. Exceptions are meant to be thrown for illegal situations like this.

Unfortunately, now, every call to `calcPay` can throw an `UnpayableEmployeeException`, so either the exception must be caught or declared by the caller. Thus, a constraint upon a *derivative* has impacted the users of the base class.

To make matters worse, the following code is now illegal.

```
for (int i = 0; i < employees.size(); i++) {
    Employee e = (Employee) employees.elementAt(i);
    totalPay += e.calcPay();
}
```

To make it legal we have to wrap the call to `calcPay` in a `try/catch` block.

```
for (int i = 0; i < employees.size(); i++) {
    Employee e = (Employee) employees.elementAt(i);
    try {
        totalPay += e.calcPay();
    }
    catch (UnpayableEmployeeException e1) {
    }
}
return totalPay;
}
```

This is ugly, complicated, and distracting. We might easily be tempted to change it to

```
for (int i = 0; i < employees.size(); i++) {
    Employee e = (Employee) employees.elementAt(i);
    if (!(e instanceof VolunteerEmployee))
        totalPay += e.calcPay();
}
```

But this is even worse because now code that was supposed to operate on the `Employee` base class makes *explicit* reference to one of its derivatives.

All this confusion has come about because we have violated the LSP. `VolunteerEmployee` is not substitutable for `Employee`. Users of `Employee` are impacted by the very presence of `VolunteerEmployee`. And this results in strange exceptions and odd `instanceof` clauses in `if` statements, all of which violate the OCP.

You know you are violating the LSP whenever you try to make it illegal to invoke a function on a derivative. You may also be violating the LSP if you make a derivative method *degenerate*, i.e. implemented with nothing. In both cases you are saying that this function makes no sense in this derivative. And that's a violation of LSP that can eventually lead to nasty exceptions and `instanceof` tests.

What's the solution to the `VolunteerEmployee` problem? Volunteers are not employees. It makes no sense to call `calcPay` on them, so they should not derive from `Employee`, and they should not be passed to functions that need to call `calcPay`.

The Dependency Inversion Principle (DIP)

A. HIGH LEVEL MODULES SHOULD NOT DEPEND UPON LOW LEVEL MODULES. BOTH SHOULD DEPEND UPON ABSTRACTIONS.

B. ABSTRACTIONS SHOULD NOT DEPEND UPON DETAILS. DETAILS SHOULD DEPEND UPON ABSTRACTIONS.

Better still: *Don't depend upon volatile concrete classes.* If you inherit from a class, make it an abstract class. If you hold a reference to a class, make it an abstract class. If you call a function, make it an abstract function.

In general, abstract classes and interfaces change far less often than their concrete derivatives. Therefore we would rather depend upon the abstractions than the concretions. Following this principle reduces the impact that a change can have upon the system.

Does this mean we can't use `Vector`, or `String`? After all, they are concrete classes. Does using them constitute a violation of DIP? No. It is perfectly safe to depend upon concrete classes that are not going to change. `Vector` and `String` are not going to change (much) in the next decade, so we can feel relatively safe using them.

It's the *volatile* concrete classes that we want to avoid depending upon. These are the concrete classes that are under active development, and that capture business rules that are likely to change. We want to create interfaces for these classes and depend upon those interfaces.

From a UML standpoint, this principle is very easy to check. Follow every arrow in a UML diagram and check to make sure the target of the arrowhead is an interface or an abstract class. If not, and if the concrete class is volatile, then the DIP has been violated, and the system will be sensitive to change.

The Interface Segregation Principle

CLIENTS SHOULD NOT DEPEND UPON METHODS THAT THEY DO NOT USE.

Have you ever seen a fat class? A fat class is a class that has dozens or hundreds of methods. Typically we don't want to have such classes in our systems; but sometimes they are unavoidable.

The problem with fat classes, other than the fact that they are big and ugly, is that their users seldom use all their methods. That is, a user might call just two or three methods on a class that declares dozens. Unfortunately those users are impacted when changes are made to the methods they *don't* call.

For example, consider the course enrollment system depicted in Figure 6-9. The diagram shows two clients of a class named `StudentEnrollment`. Clearly the `EnrollmentReportGenerator` does not invoke methods like `prepareInvoice` or `postPayment`. Lets also suppose that `AccountsReceivable` does not invoke the methods `getName` and `getDate`.

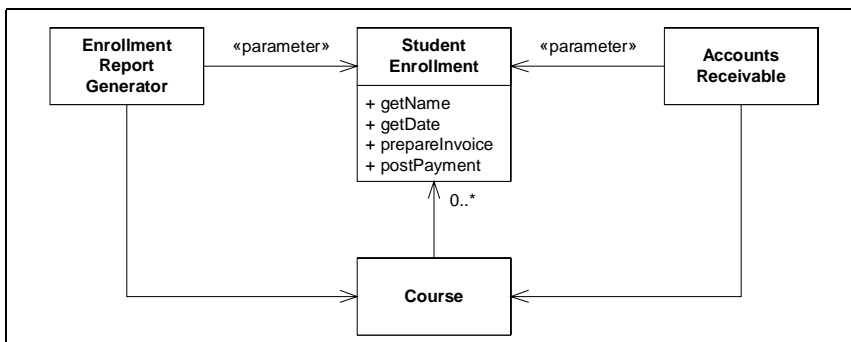

Figure 6-9
Unsegregated Enrollment System

Now, lets assume that the requirements change in a way that forces us to add a new argument to the `postPayment` method. This change to the declaration of `StudentEnrollment` may⁴ force us to recompile and redeploy `EnrollmentReportGenerator`. This is unfortunate because `EnrollmentReportGenerator` does not care at all about the `postPayment` method.

We can prevent this unfortunate dependency by following a simple rule. Protect users from methods they don't need by giving them interfaces with just the methods they do need. Figure 6-10 shows how this rule can be applied.

4. Some IDEs are smart enough to avoid such a recompile, but most are not.

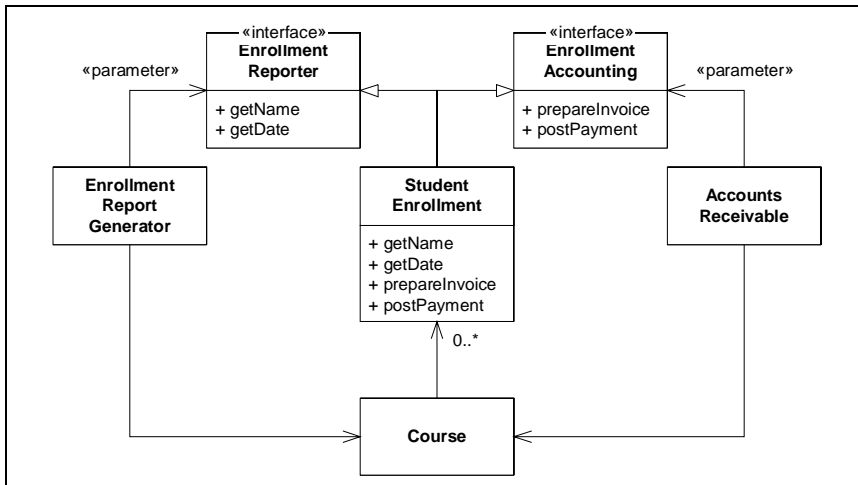

Figure 6-10
Segregated Enrollment System

Each user of a `StudentEnrollment` object is given an interface that provides just the methods that it is interested in. This protects the user from changes in methods that don't concern it. It also protects the user from knowing too much about the implementation of the object it is using.

Conclusion

So, five simple principles:

1. SRP -- A class should have one and only one reason to change.
2. OCP -- It should be possible to change the environment of a class without changing the class.
3. LSP -- Avoid making methods of derivatives illegal or degenerate. Users of base classes should not need to know about the derivatives.
4. DIP -- Depend on interfaces and abstract classes instead of volatile concrete classes.
5. ISP -- Give each user of an object an interface that has just the methods that user needs.

When should these principles be applied? At the first hint of pain. It is not wise to try to make all systems conform to all principles all the time, every time. You'll spend an eternity trying to imagine all the different environments to apply to the OCP, or all the different sources of change to apply to the SRP. You'll cook up dozens or hundreds of little interfaces for the ISP, and create lots of worthless abstractions for the DIP.

The best way to apply these principle is *reactively* as opposed to proactively. When you first detect that there is a structural problem with the code, or when you first realize that a module is being impacted by changes in another, *then* you should see whether one or more of these principles can be brought to bear to address the problem.

Of course if you take a reactive approach to applying the principles, then you also need to take a *proactive* approach to putting the kinds of pressure on the system that will create pain early. If you are going to react to pain, then you need to diligently find the sore spots.

One of the best ways to hunt for sore spots is to write lots and lots of unit tests. It works even better if you write the tests first, before you write the code that passes them. But that's a topic for the next chapter.

Bibliography

[Feathers2001]: *The 'Self'-Shunt Unit Testing Pattern*, Michael Feathers, May, 2001, <http://www.objectmentor.com/resources/articles/SelfShunPtrn.pdf>

[Martin2002]: *The Principles, Patterns, and Practices of Agile Software Development*, Robert C. Martin, Prentice Hall, 2002

7

The Practices: *dX*

Now we're going to put all this together into a set of practices that a team can use to get projects done. A group of practices like this is sometimes called a process. However, what I describe below is too lightweight to be called a process. It's just a set of simple rules that a team of developers can use to get a lot of work done in a short amount of time. I call this set of rules: *dX*¹.

Iterative Development

The key *dX* practice is to do *everything* in *short* iterations. By everything I mean requirements, analysis, design, implementation, testing, documentation, etc. Everything. By short I mean two weeks. We do everything in two week cycles. Each cycle begins with a plan, and ends with deliverables. After the initial exploration, the chief deliverable of each cycle, even the earliest of cycles, is working code.

The Initial Exploration

Our first *dX* iteration begins with an exploration of the requirements. This is the only iteration that does not end in code, and is the only iteration that may be shorter than two weeks. Typically exploration is a few days. Sometimes it is a week. On rare occasions it is two weeks.

First we need someone who will be responsible for requirements and priorities. Call this person "the Customer". In many projects this person may, in fact, be the real cus-

1. A visual pun on XP that I adopted in the paper: [Martin1999]

tomers. In other projects the role of “the Customer” may be played by a team of business analysts.

We sit down with the customer and talk over what the system has to do. For the first few days of the project we are just discussing how the system works and what behaviors it must have. We aren’t necessarily writing much down. We are not trying to capture requirements at this time, we are just trying to get an idea of the scope of the system.

As we discuss the system we identify use-cases. We write the name of each use-case down on an index card. We call these cards *user stories*. They don’t contain the details of the use-case, they contain only the name. You might write down a few other salient bits of information on the card, but we aren’t trying to be complete or thorough just yet. We’re just trying to get our arms around the overall system.

This exploration process never ends. Even when we are in the depths of implementation, even after the N^{th} release of the system has been shipped, we are still going to be sitting down with the customer and regularly discussing new needs and features.

Estimating the features

We write an estimate on each user story card. This estimate is a dimensionless number. We don’t care what the units are at this point. All we care about is that the estimates are proportional to each other. That is, a story with an estimate of eight will take twice as long as a story with an estimate of four.

The best way to estimate is to base the estimate for a story on a previously implemented story. If you’ve done a story like the one you are currently estimating, and you know that the estimate on the previous story was six, you can make the estimate on the new story five, six, or seven depending upon how much simpler or harder the new story is.

If you don’t have older stories to base your estimates on, then you can start estimating by using *perfect programming days*. Perfect programming days are days in which you went to bed on time the previous night, ate a hearty breakfast this morning, there was no traffic on the way to work, the phone never rings all day, there are no meetings, your computer never crashes, the network seems infinitely fast, and your co-workers are intelligent, patient, and considerate. How much could you get done on a day like that? How many days like that would it take to get the story you are estimating done. Write down that number and then forget that it had anything to do with days -- because, in reality, it doesn’t.

Stories that are too long should be split. Stories that are too short should be merged. A story should never be longer than three or four days worth of effort for the whole team. They should never be shorter than about half a day’s effort. Stories that are too short tend to be over-estimated. Stories that are too long tend to be under-estimated. So we merge and join stories until they sit near the sweet spot of accurate estimation².

2. Accurate Estimation. Now there’s an oxymoron for you.

Spikes

As our last act of the initial exploration we will spend two or three days doing a quick and dirty implementation of two or three interesting stories. We are going to throw this implementation away. The goal is simply to calibrate our estimates. Say, for example, that it took five man days to implement a story with a seven on it. That would imply that for quick and dirty implementations we can do seven points in five days. Perhaps it will take three times longer to do the same implementation in production quality. So we'll reduce our calibration to seven points in fifteen days. We'll round that down to half a point per day. This number is our initial *velocity*.

Planning

Now that we have stories, estimates, and and velocity, we can start planning our iterations. Planning is simply a matter of using the current velocity to figure out which stories will be done each iteration.

Planning Releases

We begin by planning the first release. A release is typically six iterations or about three months. Lets say we have five people on our team. That means we can do about fifty man days per iteration. In six iterations we can get 300 man days of work done. At our current velocity of .5, we can get 150 story points done. So the customer picks stories with estimates that add up to 150. The customer picks the stories that are most important and cost effective. This batch of stories becomes the release plan.

Planning Iterations

On the first day of each iteration we create a plan for that iteration. An iteration contains fifty man days. At our current velocity that means we can do about 25 story points. So the customer selects stories from the release plan that add up to 25. This is the initial iteration plan.

We take the stories that the customer selected and break them down into *tasks*. A task is much smaller than a story. It is a unit of work on the order of four to ten man hours in size. A task is a simple unit of work that a single developer can take responsibility for. It's a single dialog box, or a single database transaction, or something along those lines.

The customer helps us do the task breakdown, talking us through the details of the requirements. The customer also helps us make priority tradeoffs. He points out which parts of a feature are important and which are not. He helps us identify whether a glitzy UI is important or not. He helps us keep the business value of the iteration high.

Usually it will take us two or three hours to break the stories down into tasks. During that time we write the tasks on a whiteboard or a flip chart of something. Next we sign up to take responsibility for tasks.

Signup is a simple process. Each developer keeps a budget in the back of his or her head. This budget is the number of man hours the developer will spend actually working on tasks during this iteration. As the developer signs up for a task, he estimates that task, and then subtracts that estimate from his budget. A developer can continue to sign up for tasks until his budget is zero.

We don't assign tasks to developers, we let them sign. We find that the developers can usually work out the best distribution of tasks in this manner. We also let each developer estimate the tasks they are signing up for.

Ideally, at the end of the signup, every task will have an owner, and every developer's budget will be at zero. This seldom happens. Usually, especially during the first iterations, there are lots of tasks left on the board, and all the developer's budgets are at zero.

When this happens, the developers try to work out another way to divvy up the tasks. Perhaps someone signed up for a task that doesn't play to their strengths. Maybe that task should be done by someone else. The developers hash this out for a while in an effort to get more tasks signed up.

If there are still tasks left on the board, then the developers tell the customer that they can't get all 25 story points done. The customer removes stories from the iteration until all the tasks can be signed up.

Ideally, the plan is finalized at about noon.

The midpoint.

Lets say that we finally settled on 20 story points for the iteration. Now we start analyzing, designing, and implementing those stories. We'll talk about how to do that in the next few sections. Right now I want to jump forward to Monday morning -- the midpoint of the iteration.

On Monday morning we should have 10 story points done. We calculate the completed story points by adding up the estimates of the stories that are complete. This prevents us from getting all the stories half done. What we want is to get half the stories done.

If we don't have 10 story points done, then we aren't going as fast as we thought. Lets say we only got 8 story points done. Then we need to tell the customer that it's not likely that we'll get more than 16 story points done for the whole iteration. We ask the customer to remove a story or two so that the total is 16.

By the same token, if we are more than half done, then we ask the customer to add extra stories to the iteration. For example, if we have 15 story points done, then it looks like we might get a total of 30 done for the iteration. So we ask the customer to add more stories.

Velocity Feedback.

We stop the iteration on Friday afternoon whether we have completed all the stories or not. Then we recompute our velocity. If we completed 23 story points then our velocity is 23 story points per iteration. The following Monday, when we do the plan for the next iteration, the customer will select stories that add up to 23.

This is how we continuously calibrate our estimates. We measure how many story points we got done each iteration and sign up only for that many in the next iteration. We measure how many story points we got done during the previous release, and sign up only for that many for the next release. Individually we measure how many man hours worth of tasks we completed in the last iteration and only sign up for that many tasks in the next iteration.

Organizing the Iterations into Management Phases

The *Unified Process*³ suggests that projects go through four management phases. During the *Inception* phase we are trying to determine the feasibility and business case for the system. During the *Elaboration* phase we determine the architecture of the system and create a reliable plan for implementation. During the *Construction* phase we carry out the implementation of the system. Finally, during the *Transition* phase we install the system and work with the users to tune it.

Each of these phases of the Unified Process consists of one or more iterations; and each produces working code. From the programmer's point of view, there is no difference between the phases. Each is simply comprised of iterations, all of roughly the same structure. Each is a matter of identifying stories, estimating them, selecting them for implementation, and then implementing them.

What's in an Iteration?

During the two weeks of the iteration we carry out all the traditional tasks of software development. We analyze the requirements, design a solution, and implement that solution. However, we restrict our scope to *only* the stories selected for the current iteration. We do not consider any other stories that might be selected in future iterations. Our focus is on this iteration and only this iteration.

One might complain that this leads to poor architectures, inflexible designs, or lots of rework. On the contrary it leads to the best architectures, very flexible designs, and very little rework. The reason is simple, we are always working on the most important features. The customer selects the features to be developed in each iteration based upon business

3. [Kruchten1998]

value. Any feature scheduled for a later iteration is, by definition, not as important as the feature we are currently working on. Therefore our attention is always on the most important thing it can be one.

There are a set of practices that we like to follow while implementing stories. They help us to write clean flexible code. They help us keep our defect rate down and create flexible and easy to understand designs. They help us communicate with the customer, and eliminate surprises.

Developing in Pairs

Firstly, when using *dX*, we develop all software in pairs. Two developers work together at a single workstation implementing a task that one of them signed up for. Both programmers are fully engaged in writing the code. Both have their eyes locked on the screen. One may control the keyboard, but both know exactly what is about to happen. Indeed, the keyboard moves rapidly back and forth between them. I've even seen instances where one developer uses the keyboard while another uses the mouse.

We changes partners once per day. The owner of the task stays with his task, and recruits others to work with him. On average each programmer will spend about half his time working on the tasks he signed up for. The other half of his time will be spend helping other people with their tasks.

You might think this cuts productivity in half. After all, the owner of each task is only spending half his time on that task. However, the loss of productivity does not seem to happen. It turns out that pairing is a very efficient way to write software.

Acceptance Tests

At the start of each *dX* iteration, once the customer has selected the stories to be implemented, the customer and QA folks work together to flesh the user stories into use-cases and to write executable acceptance tests for the stories. These tests delivered to the programmers before the iteration is half over⁴. These tests are the true requirements document. It is in these tests that the details of the requirements are truly documented.

Once the developers receive the tests, they *know* what their stories and tasks must accomplish. They run the tests continuously throughout development making sure that they never break any that have passed. A good iteration ends in a kind of anti-climax with everybody going home early Friday afternoon, all acceptance tests passing.

4. At least one QA manager I know of made it his goal to deliver the acceptance tests *during* the iteration planning meeting. He worked with the customer a few days before the iteration began to get an idea of which stories were most important. He then developed acceptance tests for those stories "on spec".

Unit Tests

In a *dX* project we write unit tests. Lots and lots of unit tests. Moreover we write them first, before we write the code that passes them. Indeed, the rule is that we will not write any production code until we have a unit tests that is failing. Every line of production code is written to make a particular failing unit test pass.

The technique is extremely iterative. We write a tiny fragment of a unit test, no more than five or ten lines of code. Then we compile it. Usually it won't compile because it uses code that hasn't been written yet. So we write just enough of the production code to get the test to compile. Typically this will be less than half a dozen lines of code. Then we run the test. It will fail because we did not finish writing the production code. Seeing it fail we then write just enough production code to make that one fragment of the test pass. Once it passes we add another fragment to the test and start over.

This cycle lasts between one and ten minutes depending upon the language or the environment. The faster you can go round the loop the better. And each time around the loop you run *all* the tests you have written for that module. This means that, no matter what is going on at the moment, the code was working a just a few minutes ago. We don't have dozens of windows open with dozens of modules torn to shreds hoping we can wire them all back together again. *A minute or so ago all our tests passed.*

As we work from day to day we continue to add more and more tests to the growing body of unit tests. Dozens per day, hundreds per week, thousands per month. We organize them into a body that is convenient to run. We run them all the time. We are confident in the state of our code.

The tests are a form of documentation. If you want to know how to invoke a particular API function, there is a test that does it. If you want to know how to create a certain object, there is a test that does it. The tests act as a set of examples for nearly every programming task in the system. This kind of documentation is unambiguous, accurate, compilable, and executable.

Refactoring⁵

The ability to run some or all of the suite of unit and acceptance tests, provides a simple way to determine if we've done something to break the system. If we desire to make a change, we can make it fearlessly, because the tests will tell us if we've broken anything important.

This means that we can make changes to the code with near impunity. If we see a variable that could have a better name, we can rename it. If we see a class that has too many methods, we can split it. If we see a method that is in the wrong class we can move it. Indeed, so long as we are supported by a bevy of unit and acceptance tests, we can fearlessly make any change we like.

5. [Fowler1999]

Thus, we incorporate refactoring, the act of improving a program's structure without changing its behavior, into the practices of *dX*. Every hour or so of active programming is followed by a period of refactoring. We look at the code we've written and *improve* it. We make these improvements in tiny steps, each just a few minutes long, running the tests after each step. We gradually improve the structure of the system, never letting it degrade. The rule is: *never let the sun set on bad code*.

Open Office

The best environment for *dX* is an open office, or laboratory. We put tables in the middle with workstations for pairs. We all work together in the same room, including the customer. Our goal is to work together as a team, frequently interacting with each other, able to ask quick questions of each other, get quick advice, lean over and look at some code.

Continuous Integration

The source code control system used in *dX* is non blocking. That means that anyone can check out a module, no matter who else might have it checked out. First one to check in wins. Second one to check in merges.

The possibility of merging creates an interesting tension. The longer you have a module checked out the greater the likelihood of having to do a merge. Nobody likes to merge, no matter how good the tools support is, therefore there is a pressure to check in early and often. This is a good thing.

However, *dX* has a rule about checking in. When you check in code you must first demonstrate that *all* of the unit and acceptance tests pass. That means you have to fully integrate your changes into the system, build the system, and test the system before you finish the check in.

In a *dX* project, this happens many times per day per pair. Therefore integration is happening continuously. There is never a big final integration to be performed.

Conclusion

Gosh, did I forget to mention UML? No, I didn't forget. I also didn't mention Java. That's because these tools are irrelevant to the practices. UML is not a method, UML is a notation. Java is not a method, Java is a programming language. We use these notations and languages only when we need them. They are tools to be used, not methods to be followed.

Well what about documentation? Don't we need to use UML to create useful documents? Yes, we do. However, we don't need to make them as part of a process. Documentation produced by default is almost always useless. There is a rule in *dX* known as Martin's first law of documentation. It says: *produce only those documents for which you*

have a significant and immediate need. This means that we do not draw UML diagrams as a matter of course. We do not specifically capture all requirements in class diagrams. We do not capture all use cases in sequence diagrams. We use these tools when there is an immediate and significant need, otherwise we don't use them.

In a *dX* project you will see people using UML. You'll see them at whiteboards scratching diagrams while debating different design options with each other. You'll see them producing hardcopy diagrams as roadmaps for others to follow. What you won't see are people producing diagrams because a process told them to. The only diagrams they produce are the ones they know for sure that they need right now.

The practices I described above as part of *dX* are drawn from the practices of *Extreme Programming*⁶ (XP). Indeed, if you look closely you'll see that *dX* is just *XP* turned upside-down.

Bibliography

[**Kruchten1998**]: *The Rational Unified Process*, Philippe Kruchten, Addison Wesley, Reading, MA, 1998.

[**Fowler1999**]: *Refactoring*, Martin Fowler, Addison Wesley, Reading, MA, 1999

[**Martin1999**]: *RUP vs. XP*, Robert C. Martin, 1999,
<http://www.objectmentor.com/resources/articles/RUPvsXP.pdf>

[**Beck1999**]: *Extreme Programming Explained*, Kent Beck, Addison Wesley, Reading, MA, 1999

[**Jeffries2000**]: *Extreme Programming Installed*, Ron Jeffries, et. al, Addison Wesley, Upper Saddle River, NJ, 2000

6. [Beck1999], [Jeffries2000]

8

Packages

There are two different kinds of packages that are important to Java programmers. The first is the source code package represented by the Java `package` keyword. The second is the binary component represented by a `.jar` file.

Java Packages

Java packages are namespaces. They allow programmers to create small private areas in which to declare classes. The names of those classes will not collide with identically named classes in different packages.

Java compilation systems often keep the generated binary `.class` files in directory structures that mimic the package structure of the source code. Thus, the `.class` file for the class `A.B.C` will likely be stored on disk in a file whose path is something like: `A/B/C.class`. Since Java compilers read foreign declarations from `.class` file instead of `.java` files, it is critical that both the compiler and runtime system know the appropriate classpaths for the packages included in the application.

Because of these issues it is important to give due consideration to the package structure of the system. UML has notational tools that can help with that consideration.

Packages

There are several ways to denote a package in UML. Figure 8-1 shows the simplest. The package icon is simply a rectangle with a tab on the top to make it look a bit like a file folder. The fully qualified name of the package is shown within the rectangle.

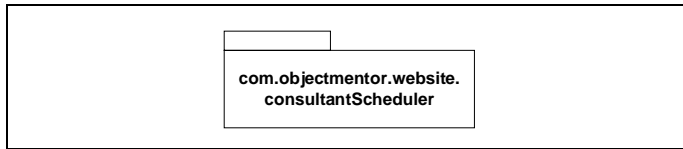

Figure 8-1
Simple UML Package

If you so desire, you can put the name of the package in the tab of the rectangle. This leaves the large rectangle free so that you can list some or all of the classes within the package. Figure 8-2 shows what this looks like.

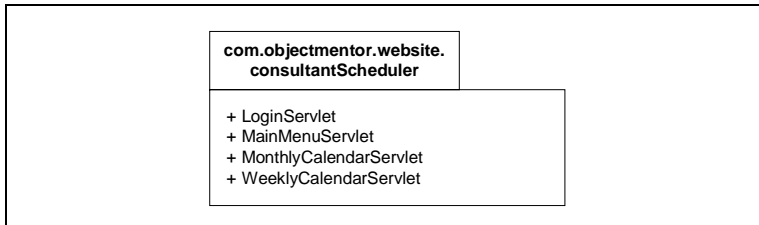

Figure 8-2
UML package showing contents.

Finally, you can show package nesting structure using the *contains* relationship as shown in Figure 8-3..

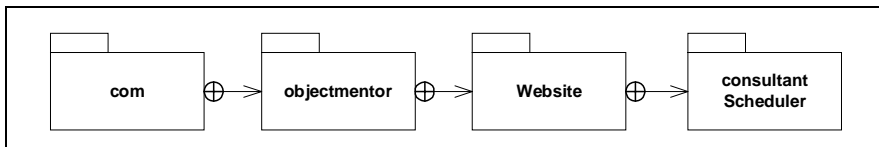

Figure 8-3

Dependencies

The code within a package often depends upon the code within another. In Java we see this when we import a class, or a group of classes, into our source code. We also see it if we use the qualified name of a class. In UML we depict this dependency by using the *dependency* relationship as shown in Figure 8-4.

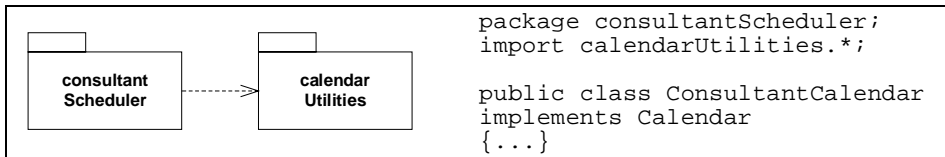

Figure 8-4
Package Dependency

Note that the dependency is not the result of the `import` statement. Rather it is the result of the actual use of `calendarUtilities.Calendar` from within `consultantScheduler.ConsultantCalendar`. In Java, `import` statements do not create a true dependency, though compilers are within their rights to complain if the imported class or package does not exist.

Binary Components -- .jar files.

While packages are convenient groupings for source code, they do not always make convenient groupings for binary code. Often we want to bundle larger chunks of binary code together into components in the form of a `.jar` file. Such a component can be conveniently deployed to the systems in which it will execute.

Components are depicted in UML as shown in Figure 8-5. The interface icon shown on the top is optional. It denotes that one of the interfaces available within the `CalendarRenderer` component is named `Calendar`.

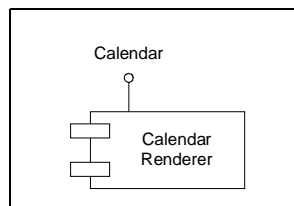

Figure 8-5
A component -- possibly a `.jar` file.

As with packages, components can also be related with dependency relationships. Indeed, usually a component contains one or more whole packages, so the dependencies between the components will usually be a subset of the dependencies between the packages.

Principles of Package Design

Over the years I've come to depend upon a simple set of principles to help me organize the large scale structure of a software application. These principles are not rules, and they are not "the right way". Rather, they are simple heuristics that help me make the tradeoffs necessary to partition a system.

You will find that these principles do not lead you to a functional decomposition. The packages that these principles lead you to create are meant to gather volatile classes together, and keep apart those classes that change for different reasons. They try to isolate those classes that change frequently from those that don't. They try to separate the high

level architecture of the system from the low level details, and keep the high level architecture independent.

These principles are discussed in great detail in [PPP2002]¹. I cover them very briefly here.

The Release/Reuse Equivalency Principle (REP)

People don't usually reuse classes. Usually they reuse groups of classes together. Such reusable groupings should be placed into a package. That package should then be tracked and released for the benefit of those who would reuse it.

This principle says that one of the criteria for placing classes into a package is to create a package that is convenient for others to reuse.

A package that is being reused by others must be treated with a certain care and respect by the author. Reusers must be notified, in advance, of changes the author intends to make to the package. The author should consider whether or not to maintain older versions of the package for a time, to give the reusers opportunity to make incorporate changes gradually. This implies a certain clerical overhead and logistics that is hard to apply on a per-class basis. Thus, creating reusable classes is convenient for both the author and the reuser.

In the end, the smallest things you can reuse is the smallest thing that someone else is willing to put the effort into releasing and tracking. The granule of reuse is the granule of release.

The Common Closure Principle (CCP)

The Single Responsibility Principle (SRP) told us to give each class one and only one reason to change. The CCP extends this to packages. We want all the classes in a package closed against the same kinds of changes. We want changes to be focussed into single packages.

Most systems are built from many, perhaps dozens or even hundreds, of packages. Those packages depend upon each other creating a large graph of dependencies. The goal of the CCP is to group classes together by their susceptibility to change. Those classes that change for the same reason are placed in the same package. Thus, when a particular change occurs, very few of the packages in the dependency structure will have to be changed.

1. *Principles, Patterns, and Practices of Agile Software Development*, Robert C. Martin, Prentice Hall, 2002.

The Common Reuse Principle (CRP)

The Interface Segregation Principle (ISP) told us to create specific interfaces for each client of a class. The CRP does the same for packages. A package that has many clients is responsible to all those packages. A change in that package can have a very large impact upon all the packages that depend upon it. Therefore, as much as is possible, we want to separate those classes that are used by a client, from those that are used by a different client.

When a package contains classes that are used by different clients, changes to one class in the package can have an impact even upon those packages that don't use the changed class. The fact that the package has changed is enough to cause the client packages to be re-released and re-deployed.

The Acyclic Dependencies Principle (ADP)

Cycles in the package dependency graph can lead to build problems and developability problems. When there are cycles, it is impossible to determine which classes and which packages should be built first, and which should be built next.

Dependencies are transitive. If package A depends upon package B, and package B depends upon package C, then package A transitively depends upon package C. This means that when there is a cycle in the package dependency graph, every package in the cycle depends upon every other package in the cycle. Such fully connected dependency graphs can make it very hard to keep the packages isolated from each other so that the developers can work on them without impacting other developers.

The solution is to keep the dependency cycles out of the package dependency graph. This can be done manually, or you can use a tool like JDepend (see www.clarkware.com) to help.

The Stable Dependencies Principle (SDP)

Some packages are meant to be easy to change. Other packages are meant to have many incoming dependencies, making them hard to change. If a package that has many incoming dependencies hangs a dependency of its own upon a package that was meant to be easy to change, then it will make that package hard to change. See Figure 8-6.

The Stable Dependencies Principle says that packages should not depend on packages that are less stable (easier to change) than themselves. The target of every package dependency will be harder to change than the depending package.

There are some simple metrics discussed in [PPP2002] that allow teams to calculate the stability of each package, and then evaluate whether or not dependencies flow in the direction of stability.

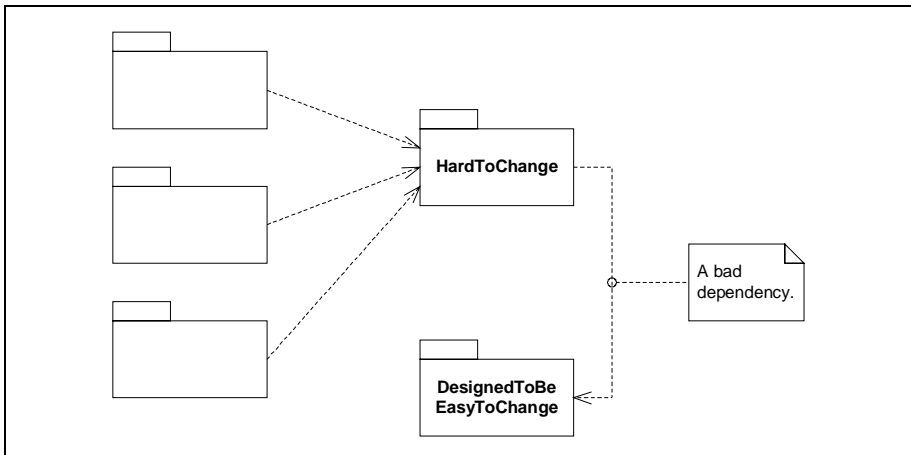

Figure 8-6
A violation of the SDP.

The Stable Abstractions Principle (SAP)

Since stable packages are hard to change, we need a way to keep them flexible. The OCP told us that a module could be extended without modifying it. Stable packages are hard to modify, but they need not be hard to extend. Thus, the SAP says that in order to keep stable packages easy to extend, stable packages should be abstract. The more stable a package is, the more abstract it should be.

The abstractness of a package is related to the number of abstract classes and interfaces it contains. The higher the ratio of abstract classes and interfaces, the more abstract the package is. According to the SAP, a package with many incoming dependencies is very stable, and should therefore also be very abstract.

The SDP and SAP combined are the package version of the DIP. The DIP told us that class relationships should point at abstract classes or interfaces. The SDP/SAP combination says that stability increases with incoming dependencies, and that abstraction should increase with stability. Therefore the abstraction of a package should increase with incoming dependencies.

Again [PPP2002] presents a set of metrics to measure the abstractness of a package, and to manage the relationship between stability and abstractness.

Conclusion

How important is it to draw package and component diagrams? It turns out that they are reasonably useful diagrams. The ADP showed us that dependency cycles between pack-

ages and components are problematic and need to be resolved. Drawing a picture of the current structure is often very useful for resolving such cycles.

Package dependency diagrams are also reasonably useful for showing the order in which packages should be compiled. Compiling packages in the wrong order can lead to bizarre build problems. The dependency diagram tells you which packages depend upon which others, and therefore which should be compiled first.

Of course the best way to create these diagrams is to generate them from the code. Diagrams of the package structure that don't contain *every* dependency that exists within the code are not particularly useful for resolving cycles or determining build order. Thus, it is not a bad idea to employ a tool that detects the dependencies and either create the dependency diagrams, or at least provides a list of the dependencies so you can make your own diagram.²

2. see www.clarkware.com for just such a tool.

Object Diagrams

Sometimes it can be useful to show the state of the system at a particular point in time. Like a snapshot of a running system, a UML Object Diagram shows the objects, relationships, and attribute values that obtain at a given instant.

A Snapshot in Time.

Some time ago I was involved with an application that allowed users to draw the floorplan of a building on a GUI. The program captured the rooms, doors, windows, and wall openings in the data structure shown in Figure 9-1. While this diagram shows you what kinds of data structures are possible, it does not tell you exactly what objects and relationships are instantiated at any given instant of time.

Lets assume that a user of our program draws two rooms, a kitchen, and a lunch room, connected by a wall opening. Both the kitchen and the lunch room have a window to the outside. The lunchroom also has a door to the outside, and it opens out. This scenario is depicted by the object diagram in Figure 9-2.

This diagram shows the objects that are currently in the system, and what other objects they are connected to. It shows `kitchen` and the `lunchRoom` as seperate instances of `Space`. It shows how these two rooms are connected by a wall opening. It shows that the outside is actually represented by another instance of `space`. And it shows all the other objects and relationships that must exist.

Object diagrams like this are useful when you need to show what the internal structure of a system looks like at a particular point in time, or when the system is in a particular state. An object diagram shows the intent of the designer. It shows the way that certain

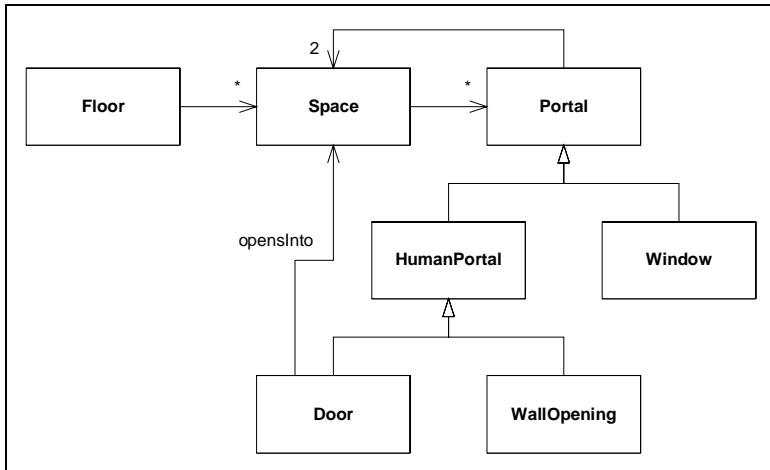

Figure 9-1
Floorplan

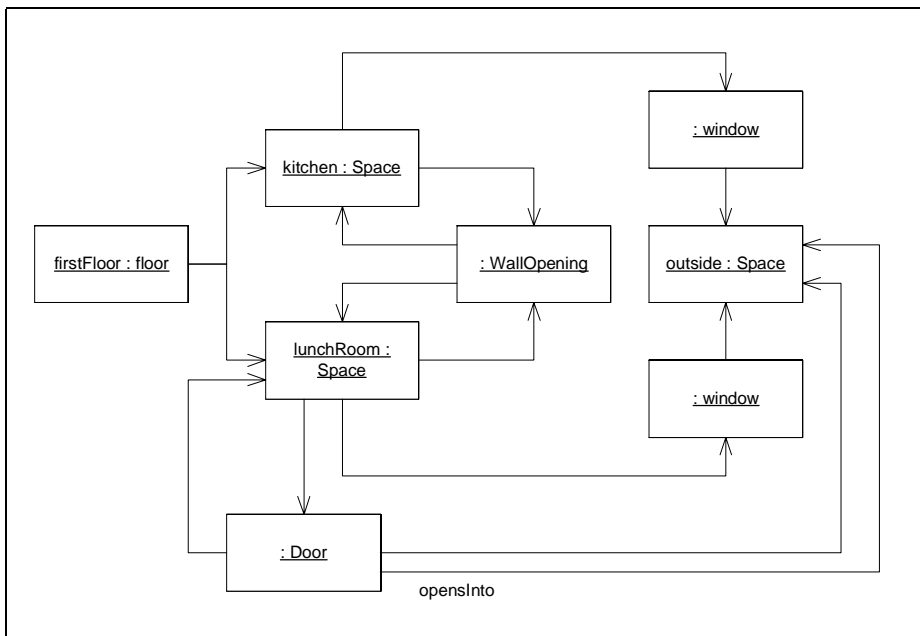

Figure 9-2
Lunch room and Kitchen

classes and relationships are actually going to be used. It can help to show how the system will change as different inputs are given to it.

But be careful, it is easy to get carried away. In the last decade I think I have drawn less than a dozen object diagrams of this kind. The need for them simply has not arisen very frequently. When they are needed, they are indispensable, and that's why I'm including them in this book. However, you aren't going to need them very often, and should definitely not assume that you need to draw them for every scenario in the system, or even for every system.

Active Objects

Another place where object diagrams are useful is in multi-threaded systems. Consider, for example, the `SocketService` code in Listing 9-1. This program implements a simple framework that allows you to write socket servers without having to deal with all the nasty threading and synchronization issues that accompany sockets.

Listing 9-1 SocketService.java

```
import java.io.IOException;
import java.net.ServerSocket;
import java.net.Socket;
import java.util.LinkedList;

public class SocketService {
    private ServerSocket serverSocket = null;
    private Thread serviceThread = null;
    private boolean running = false;
    private SocketServer itsService = null;
    private LinkedList threads = new LinkedList();

    public SocketService(
        int port, SocketServer service) throws Exception {
        itsService = service;
        serverSocket = new ServerSocket(port);
        serviceThread = new Thread(
            new Runnable() {
                public void run() {
                    serviceThread();
                }
            }
        );
        serviceThread.start();
    }

    public void close() throws Exception {
        running = false;
        serviceThread.interrupt();
        serverSocket.close();
        serviceThread.join();
        waitForServerThreads();
    }

    private void serviceThread() {
```

Listing 9-1 (Continued)
SocketService.java

```

    running = true;
    while (running) {
        try {
            Socket s = serverSocket.accept();
            startServerThread(s);
        }
        catch (IOException e) {
        }
    }
}

private void startServerThread(Socket s) {
    Thread serverThread = new Thread(new ServerRunner(s));
    synchronized (threads) {
        threads.add(serverThread);
    }
    serverThread.start();
}

private void
waitForServerThreads() throws InterruptedException {
    while (threads.size() > 0) {
        Thread t;
        synchronized (threads) {
            t = (Thread) threads.getFirst();
        }
        t.join();
    }
}

private class ServerRunner implements Runnable {
    private Socket itsSocket;

    ServerRunner(Socket s) {
        itsSocket = s;
    }

    public void run() {
        try {
            itsService.serve(itsSocket);
            synchronized (threads) {
                threads.remove(Thread.currentThread());
            }
            itsSocket.close();
        }
        catch (IOException e) {
        }
    }
}
}

```

The class diagram for this code is shown in Figure 9-3. It's not very inspiring. It is difficult to see what the intent of this code is from the class diagram. It shows all the classes and relationships alright, but somehow the big picture doesn't come through.

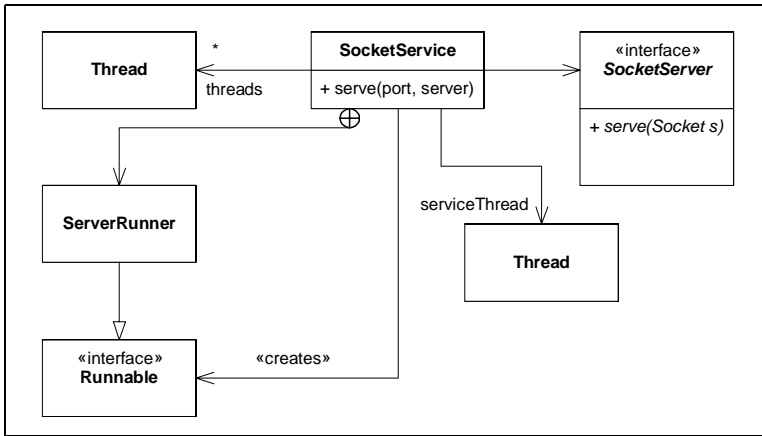

Figure 9-3
SocketService class diagram.

However, look at the object diagram in Figure 9-4. This shows the structure much better than the class diagram. It shows that the `SocketService` holds onto the `serviceThread`, and that the `serviceThread` runs in an anonymous inner class. It shows that the `serviceThread` is responsible for creating all the `ServerRunner` instances.

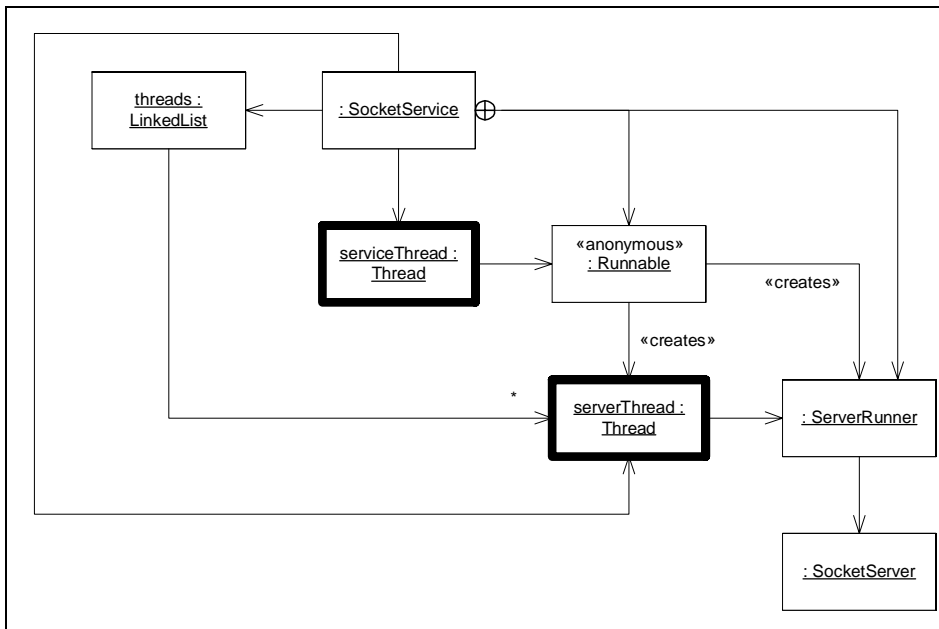

Figure 9-4
SocketService Object Diagram

Note the heavy bold lines around the `Thread` instances. Objects with heavy bold borders are known as *active objects*. Active objects act as the head of a thread of control. They contain the methods that control the thread, such as `start`, `stop`, `setPriority`, etc. In this diagram all the active objects are instances of `Thread` because all the processing is done in derivatives of `Runnable` that the `Thread` instances hold references to. The `Runnable` derivatives aren't active, because they don't control the thread. Rather, the thread invokes them.

Why is the object diagram more expressive than the class diagram? Because the structure of this application is built at runtime. The structure is more about objects than it is about classes.

Conclusion

Object diagrams show you a snapshot of the state of the system at a particular instant of time. This can be a useful way to depict a system, especially when the system's structure is built dynamically instead of imposed by the static structure of its classes. However, one should be leary of drawing many object diagrams. Most of them can be inferred directly from corresponding class diagrams, and therefore serve little purpose.

State Diagrams

UML has a very rich set of notations for describing finite state machines (FSMs). We'll look at the most useful bits of that notation in this chapter. FSMs are an enormously useful tool for writing all kinds of software. I use them for GUIs, communication protocols, and any other event based system. Unfortunately, I find that too many developers are unfamiliar with the concepts of FSMs and are therefore missing many simplifying opportunities. I'll do my small part to correct that in this chapter.

The Basics

Figure 10-1 shows a simple *State Transition Diagram* (STD) that describes a finite state machine that controls the way a user logs in to a system. The round rectangles represent *states*. The name of each state is in its upper compartment. In the lower compartment are special actions that tell us what to do when the state is entered or exited. For example, as we enter the `Prompting for Login` state, we invoke the `showLoginScreen` action. When we exit that state, we invoke the `hideLoginScreen` action.

The arrows between the states are called *transitions*. Each is labeled with the name of the event that triggers the transition. Some are also labeled with an action to be performed when the transition is triggered. For example, if we are in the `Prompting for Login` state, and we get a `login` event, then we transition to the `Validating User` state and invoke the `validateUser` action.

The black circle in the upper left of the diagram is called an *initial pseudo state*. A finite state machine begins its life following the transition out of this pseudo state. Thus, our state machine starts out transitioning into the `Prompting for Login` state.

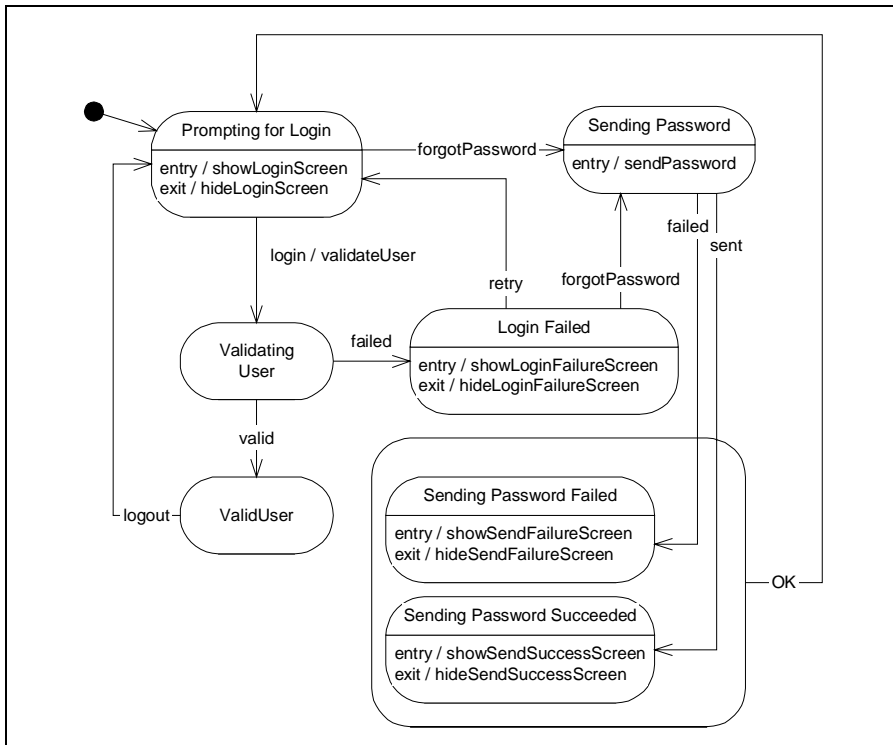

Figure 10-1
Simple Login State Machine

I drew a *superstate* around the Sending Password Failed and Sending Password Succeeded states because both states react to the OK event by transitioning to the Prompting for Login state. I didn't want to draw two identical arrows, so I used the convenience of a superstate.

This finite state machine makes it clear how the login process works. It also breaks the process down into nice compact little functions. If we implement all the action functions like `showLoginScreen`, `validateUser`, and `sendPassword`, and wire them up with the logic shown in the diagram, then we can be sure that the login process will work.

Special Events

The lower compartment of a state contains event / action pairs. The entry and exit events are standard, but as you can see from Figure 10-2 you can supply your own events if you like. If one of these special events occurs while the FSM is in that state, then the corresponding action is invoked.

Before UML, I used to represent a special event like this as a transition arrow that looped around back to the same state as in Figure 10-3. However, in UML this has a

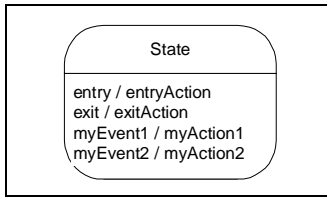

Figure 10-2
States in UML

slightly different meaning. Any transition that exits a state will invoke the `exit` action (if any). Likewise any transition that enters a state will invoke the `entry` action (if any). Thus, in UML, a reflexive transition like Figure 10-3 invokes not only `myAction`, but also the `exit` and `entry` actions.

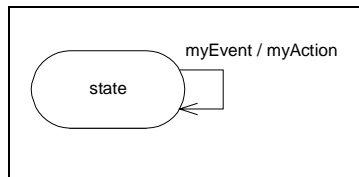

Figure 10-3
Reflexive Transition

Super States

As you saw in the login FSM in Figure 10-1, super states are convenient when you have many states that respond to some of the same events in the same way. You can draw a super state around those similar states and simply draw the transition arrows leaving the super state instead of leaving the individual states. Thus, the two diagrams in Figure 10-4 are equivalent.

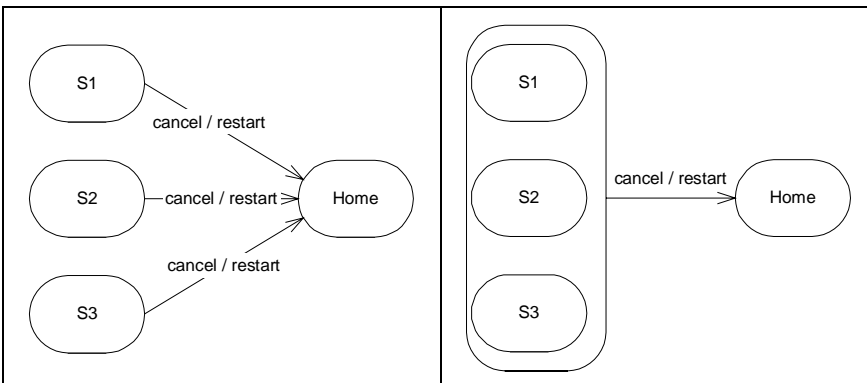

Figure 10-4

Super state transitions can be overridden by drawing explicit transition from the sub-states. Thus, in Figure 10-5, the `pause` transition for `S3` overrides the default `pause` transition for the `Cancelable` superstate. In this sense, a superstate is rather like a base class. Substates and override their superstate transitions the same way that derived classes can override their base class methods. However, it is inadvisable to push this metaphor too far. The relationship between superstates and substates is not really equivalent to inheritance.

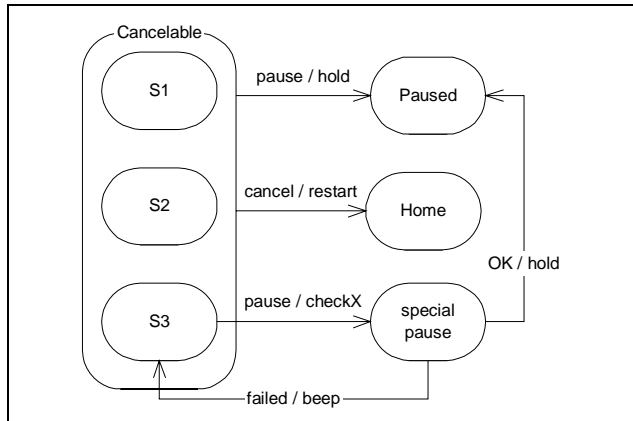

Figure 10-5
Overriding superstate transitions

Superstates can have `entry`, `exit`, and special events the same way that normal states can have them. Figure 10-6 shows an FSM in which there are `exit` and `entry` actions in both super states and sub states. As the FSM transitions from `Some State` into `Sub` it first invokes the `enterSuper` action, followed by the `enterSub` action. Likewise, if the FSM transitions out of `Sub2` back to `Some State`, it first invokes `exitSub2` and then `exitSuper`. However, since the `e2` transition from `Sub` to `Sub2` does not exit the superstate, it simply invokes `exitSub` and `enterSub2`.

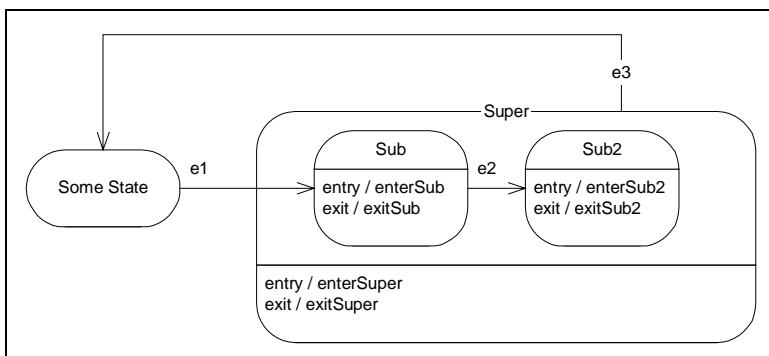

Figure 10-6
Hierarchical invocation of Entry and Exit actions.

Initial and Final Pseudo States

Figure 10-7 shows two pseudo states that are commonly used in UML. FSMs come into existence *in the process of* transitioning out of the initial pseudo state. The transition leading out of the initial pseudo state cannot have an event, since the event is the creation of the state machine. It can, however, have an action. This action will be the first action invoked after the creation of the FSM.

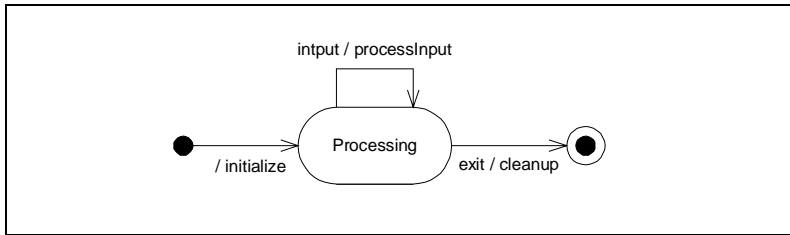

Figure 10-7
Initial and Final Pseudo states

Similarly, a FSM dies in the process of transitioning into the *final pseudo state*. The final pseudo state is never actually reached. If there is an action on the transition into the final pseudo state, it will be the last action invoked by the FSM.

Using FSM Diagrams

I find diagrams like this to be immensely useful for figuring out state machines for subsystems whose behavior is well known. On the other hand, most systems that are amenable to FSMs do not have behaviors that are well known in advance. Rather the behaviors of most systems grow, and evolve over time. Diagrams aren't a conducive medium for systems that must change frequently. Issues of layout and space intrude upon the content of the diagrams. This intrusion can sometimes prevent designers from making needed changes to a design. The spectre of reformatting the diagram prevents them from adding a needed class, or state and causes them to use a substandard solution that doesn't impact the diagram layout.

Text, on the other hand, is a very flexible medium for dealing with change. Layout issues are at a minimum, and there is always room to add lines of text. Therefore, for systems that evolve, I create *State Transition Tables* (STTs) in text files rather than STDs. Consider the STD of the subway turnstile in Figure 10-8. This can be easily represented as an STT as shown in Figure 10-9.

The STT is a simple table with four columns. Each row of the table represents a transition. Look at each transition arrow on the diagram. You'll see that the table row contains the two endpoints of the arrow, and the event and action of the arrow. You read the STT

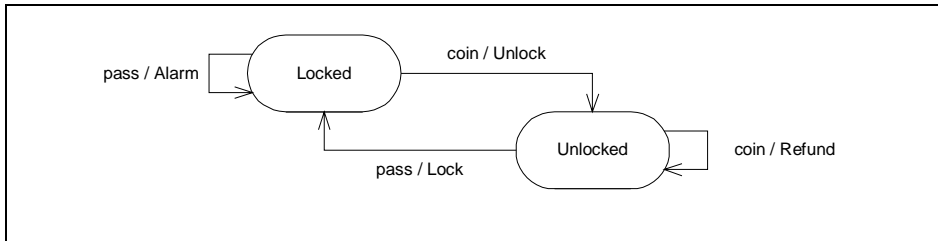

Figure 10-8
Subway Turnstile STD

Current State	Event	New State	Action
Locked	coin	Unlocked	Unlock
Locked	pass	Locked	Alarm
Unlocked	coin	Unlocked	Refund
Unlocked	pass	Locked	Lock

Figure 10-9
Subway Turnstile STT

using the following sentence template: “If we are in the Locked state, and we get a coin event, then we go to the Unlocked state and invoke the Unlock function.”

This table can be converted into a text file very simply:

```

Locked coin Unlocked Unlock
Locked pass Locked Alarm
Unlocked coin Unlocked Refund
Unlocked pass Locked Lock
  
```

These sixteen words contain all the logic of the finite state machine. It should be possible to write a simple compiler that reads the text file and generates code that implements that logic.

SMC

So, about 15 years ago, I wrote a simple compiler, named SMC, that reads STTs and generated C++ code to implement the logic. Since then SMC has grown and changed to emit code for different languages. SMC is freely available from the resources section of www.objectmentor.com.

The input to SMC for the turnstile is shown in Listing 10-1. Most of this syntax is pretty easy to understand. The details are explained in the `smc.txt` document that you can download from the previously mentioned URL. The `FSMName` header supplies the name of the class that SMC will generate. The `Context` header tells SMC the name of a class that the FSM should inherit from.

The code generated from this input is shown in Listing 10-2. It makes use of the STATE pattern. One generated, this code never needs to be edited, or even examined. It

Listing 10-1
Turnstile.sm

```

Context TurnStileContext
FSMName TurnStile
Initial Locked
{
    Locked
    {
        Coin      Unlocked  Unlock
        Pass      Locked    Alarm
    }
    Unlocked
    {
        Coin      Unlocked  Thankyou
        Pass      Locked    Lock
    }
}

```

simply implements the logic, allowing the action functions to be implemented in the Context class.

Listing 10-2
TurnStile.java (Generated)

```

public class TurnStile extends TurnStileContext {
    private State itsState;
    private static String itsVersion = "";
    private static Locked itsLockedState;
    private static Unlocked itsUnlockedState;

    public TurnStile() {
        itsLockedState = new Locked();
        itsUnlockedState = new Unlocked();
        itsState = itsLockedState;
    }

    public String getVersion() {
        return itsVersion;
    }

    public String getCurrentStateName() {
        return itsState.stateName();
    }

    public void Pass() {
        itsState.pass();
    }

    public void Coin() {
        itsState.coin();
    }

    private abstract class State {
        public abstract String stateName();

        public void pass() {
            FSMError("Pass", itsState.stateName());
        }
    }
}

```

Listing 10-2 (Continued)
TurnStile.java (Generated)

```

    }

    public void coin() {
        FSMError("Coin", itsState.stateName());
    }

}

private class Locked extends State {
    public String stateName() {
        return "Locked";
    }

    public void pass() {
        Alarm();
        itsState = itsLockedState;
    }

    public void coin() {
        Unlock();
        itsState = itsUnlockedState;
    }
}

private class Unlocked extends State {
    public String stateName() {
        return "Unlocked";
    }

    public void pass() {
        Lock();
        itsState = itsLockedState;
    }

    public void coin() {
        Thankyou();
        itsState = itsUnlockedState;
    }
}
}

```

Creating and maintaining finite state machines in this form is much easier than trying to maintain diagrams, and generating the code saves lots of time. So, though diagrams can be very useful to help you think through or present a FSM to others, the text form is much more convenient for development.

ICE: A Case Study

Several years ago I was involved in a workstation project named ICE. Users sat at GUIs and worked through a sequence of screens using a fairly simple workflow. The logic of the GUI is shown in Figure 10-10. This diagram was never drawn while the project was being developed; I just drew it here to show you how a complex FSM would be drawn in UML.

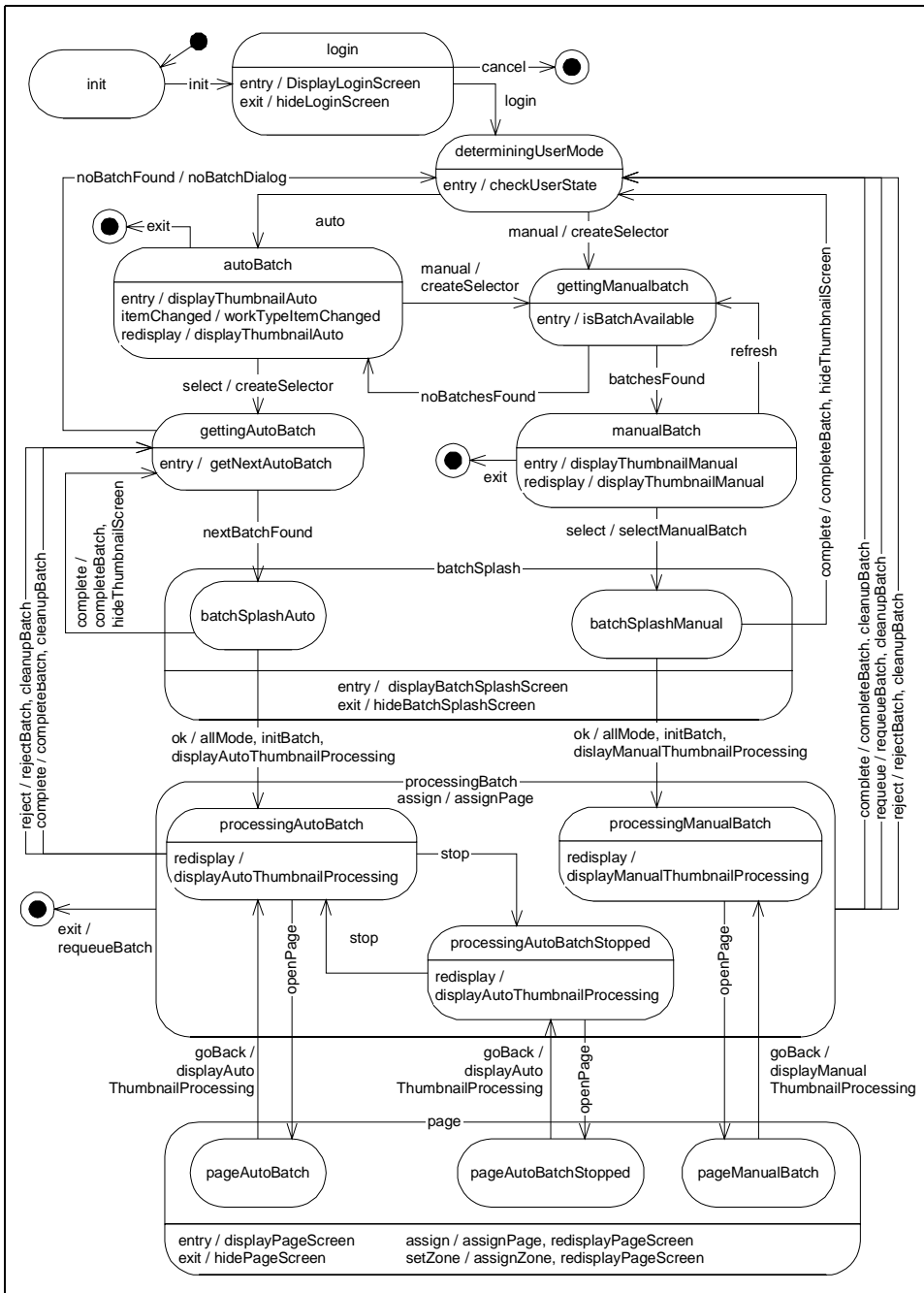

Figure 10-10
ICE FSM

The SMC input for this diagram is shown in Listing 10-3. This source file grew from humble beginnings to the full description you see now. This file was easy to create, easy to maintain, and fit very nicely into our build procedure.

Listing 10-3
ice.sm

```
Context RootFSM
Initial init
FSMName RootFSMGen
Version 042399 1528 rcm
FSMGenerator smc.generator.java.SMJavaGenerator
Pragma Package root
{
    init
    {
        init          login          {}
    }

    login <displayLoginScreen >hideLoginScreen
    {
        login          determiningUserMode {}
        cancel         end              {}
    }

    determiningUserMode < { cleanupThumbnails checkUserState }
    {
        auto          autoBatch          {}
        manual        gettingManualBatch { createSelector }
    }

    autoBatch < { setUserAuto displayThumbnailAuto }
    {
        manual        gettingManualBatch { createSelector }
        select        gettingAutoBatch   { createSelector }
        itemChanged   *                   workTypeItemChanged
        redisplay     *                   displayThumbnailAuto
        exit          end                 {}
    }

    gettingAutoBatch <getNextAutoBatch
    {
        nextBatchFound batchSplashAuto   {}
        noBatchFound   determiningUserMode { noBatchDialog }
    }

    gettingManualBatch <isBatchAvailable
    {
        batchesFound   manualBatch       {}
        noBatchFound   autoBatch         {}
    }

    manualBatch < { setUserManual displayThumbnailManual }
    {
```

Listing 10-3
ice.sm

```

    auto      autoBatch      {}
    refresh   gettingManualBatch {}
    select    batchSplashManual selectManualBatch
    redisplay *                displayThumbnailManual
    exit      end              {}
}

(processingBatch) >hideThumbnailScreen
{
    ok        *                {}
    cancel    *                {}

    complete  determiningUserMode { completeBatch
                                   cleanupBatch }
    requeue   determiningUserMode { requeueBatch
                                   cleanupBatch }
    reject    determiningUserMode { rejectBatch
                                   cleanupBatch }
    assign    *                assignPage
    exit      end              requeueBatch
}

processingAutoBatch : processingBatch
{
    stop      processingAutoBatchStopped {}
    complete  gettingAutoBatch          { completeBatch
                                   cleanupBatch }
    reject    gettingAutoBatch          { rejectBatch
                                   cleanupBatch }
    openPage  pageAutoBatch              {}
    redisplay *                          {}
    displayAutoThumbnailProcessing
}

processingAutoBatchStopped : processingBatch
{
    complete  determiningUserMode      { completeBatch
                                   cleanupBatch }
    reject    determiningUserMode      { rejectBatch
                                   cleanupBatch }
    openPage  pageAutoBatchStopped     {}
    stop      processingAutoBatch      {}
    redisplay *                          {}
    displayAutoThumbnailProcessing
}

processingManualBatch : processingBatch
{
    openPage  pageManualBatch           {}
    redisplay *                          {}
    displayManualThumbnailProcessing
}

```

Listing 10-3

ice.sm

```

(batchSplash) <displayBatchSplashScreen
>hideBatchSplashScreen
{
}

batchSplashAuto : batchSplash
{
    ok          processingAutoBatch {allMode initBatch
                                displayAutoThumbnailProcessi
ng}
    complete    gettingAutoBatch   {completeBatch
                                hideThumbnailScreen}
}

batchSplashManual : batchSplash
{
    ok          processingManualBatch {allMode initBatch
                                displayManualThumbnailProcessi
ng}
    complete    determiningUserMode  {completeBatch
                                hideThumbnailScreen
n}
}

}

(page) <displayPageScreen >hidePageScreen
{
    assign      *          {assignPage redisplayPageScreen}
    setZone     *          {assignZone redisplayPageScreen}
}

pageAutoBatch : page
{
    goBack      processingAutoBatch
displayAutoThumbnailProcessing
}

pageAutoBatchStopped : page
{
    goBack      processingAutoBatchStopped
                                displayAutoThumbnailProcess
ing
}

pageManualBatch : page
{
    goBack      processingManualBatch
                                displayManualThumbnailProcessing
}

end <exitProgram
{
}
}

```

Conclusion

Finite state machines are a powerful concept for structuring software. UML provides a very powerful notation for visualizing FSMs. However, it is easier to develop and maintain an FSM using a textual language than as a diagram.

Heuristics and Coffee

Over the past dozen years I have taught, and continue to teach, OO design to professional software developers. My courses are divided into morning lectures and afternoon exercises. For the exercises I will divide the class up into teams and have them solve a design problem using UML. The next morning we choose one or two teams to present their solutions on a whiteboard, and we critique their designs.

I have taught these courses hundreds of times and have noticed that there are a group of design mistakes that are commonly made by the students. This chapter presents a few of the most common errors, shows why they are errors, and addresses how they can be corrected. Then it goes on to solve the problem in a way that I think resolves all the design forces nicely.

The Mark IV Special Coffee Maker

During the first morning of an OOD class I present the basic definitions of classes, objects, relationships, methods, polymorphism, etc. At the same time I present the basics of UML. Thus, the students learn the fundamental concepts, vocabulary, and tools of object oriented design.

During the afternoon I give the class the following exercise to work on. I ask them to design the software that controls a simple coffee maker. Here is the specification I give them.¹

The Mark IV Special Coffee Maker

1. This problem comes from my first book: *Designing Object Oriented C++ Applications using the Booch Method*, Robert C. Martin, Prentice Hall, 1995.

The Mark IV special makes up to 12 cups of coffee at a time. The user places a filter in the filter holder, fills the filter with coffee grounds, and slides the filter holder into its receptacle. The user then pours up to 12 cups of water into the water strainer and presses the “Brew” button. The water is heated until boiling. The pressure of the evolving steam forces the water to be sprayed over the coffee grounds, and coffee drips through the filter into the pot. The pot is kept warm for extended periods by a warmer plate, which only turns on if there is coffee in the pot. If the pot is removed from the warmer plate while coffee is being sprayed over the grounds, the flow of water is stopped, so that brewed coffee does not spill on the warmer plate. The following hardware needs to be monitored or controlled:

- The heating element for the boiler. It can be turned on or off.
- The heating element for the warmer plate. It can be turned on or off.
- The sensor for the warmer plate. It has three states: `warmerEmpty`, `potEmpty`, `potNotEmpty`.
- A sensor for the boiler, which determines if there is water present or not. It has two states: `boilerEmpty` or `boilerNotEmpty`.
- The brew button. This is a momentary button that starts the brewing cycle. It has an indicator that lights up when the brewing cycle is over and the coffee is ready.
- A pressure-relief valve that opens to reduce the pressure in the boiler. The drop in pressure stops the flow of water to the filter. It can be opened or closed.

The hardware for the Mark IV has been designed and is currently under development. The hardware engineers have even provided a low-level API for us to use, so we don’t have to write any bit-twiddling I/O driver code. The code for these interface functions is in Listing 11-1. If this code looks strange to you, just keep in mind that it was written by hardware engineers.

Listing 11-1
CoffeeMakerAPI.java

```
public interface CoffeeMakerAPI {
    public static CoffeeMakerAPI api = null; // set by main.

    /**
     * This function returns the status of the warmer-plate
     * sensor. This sensor detects the presence of the pot
     * and whether it has coffee in it.
     */
    public int getWarmerPlateStatus();

    public static final int WARMER_EMPTY = 0;
    public static final int POT_EMPTY = 1;
    public static final int POT_NOT_EMPTY = 2;

    /**
     * This function returns the status of the boiler switch.
     * The boiler switch is a float switch that detects if
     * there is more than 1/2 cup of water in the boiler.
     */
}
```

Listing 11-1 (Continued)
CoffeeMakerAPI.java

```
*/
public int getBoilerStatus();

public static final int BOILER_EMPTY = 0;
public static final int BOILER_NOT_EMPTY = 1;

/**
 * This function returns the status of the brew button.
 * The brew button is a momentary switch that remembers
 * its state. Each call to this function returns the
 * remembered state and then resets that state to
 * BREW_BUTTON_NOT_PUSHED.
 *
 * Thus, even if this function is polled at a very slow
 * rate, it will still detect when the brew button is
 * pushed.
 */
public int getBrewButtonStatus();

public static final int BREW_BUTTON_PUSHED = 0;
public static final int BREW_BUTTON_NOT_PUSHED = 1;

/**
 * This function turns the heating element in the boiler
 * on or off.
 */
public void setBoilerState(int boilerStatus);

public static final int BOILER_ON = 0;
public static final int BOILER_OFF = 1;

/**
 * This function turns the heating element in the warmer
 * plate on or off.
 */
public void setWarmerState(int warmerState);

public static final int WARMER_ON = 0;
public static final int WARMER_OFF = 1;

/**
 * This function turns the indicator light on or off.
 * The indicator light should be turned on at the end
 * of the brewing cycle. It should be turned off when
 * the user presses the brew button.
 */
public void setIndicatorState(int indicatorState);

public static final int INDICATOR_ON = 0;
public static final int INDICATOR_OFF = 1;

/**
 * This function opens and closes the pressure-relief
 * valve. When this valve is closed, steam pressure in
 * the boiler will force hot water to spray out over
```

Listing 11-1 (Continued)
CofeeMakerAPI.java

```
* the coffee filter. When the valve is open, the steam
* in the boiler escapes into the environment, and the
* water in the boiler will not spray out over the filter.
*/
public void setReliefValveState(int reliefValveState);

public static final int VALVE_OPEN = 0;
public static final int VALVE_CLOSED = 1;
}
```

A Challenge.

If you want a challenge, stop reading here and try to design this software yourself. Remember that you are designing the software for an simple embedded real-time system. What I expect of my students is a set of class diagrams, sequence diagrams, and state machines.

A Common, but Hideous, Coffee Maker Solution

By far the most common solution that my students present is the one in Figure 11-1. In this diagram we see the central `CoffeeMaker` class surrounded by minions that control the various devices. The `CoffeeMaker` contains a `Boiler`, a `WarmerPlate`, a `Button`, and a `Light`. The `Boiler` contains a `BoilerSensor` and a `BoilerHeater`. The `WarmerPlate` contains a `PlateSensor` and a `PlateHeater`. Finally there are two base classes, `Sensor` and `Heater`, that act as parents to the `Boiler` and `WarmerPlate` elements.

It is hard for beginners to appreciate just how hideous this structure is. There are quite a few rather serious errors lurking in this diagram. Many of these errors would not be noticed until you actually tried to code this design and found that the code was absurd.

But before we get to the problems with the design itself, lets look at the problems with the way the UML is created.

MissingMethods.

The biggest problem that Figure 11-1 exhibits is a complete lack of methods. We are writing a program here; and programs are about behavior! Where is the behavior in this diagram?

When designers create diagrams without methods they may be partitioning the software on something other than behavior. Partitionings that are not based upon behavior are almost always significant errors. It is the behavior of a system that is the first clue to how the software should be partitioned.

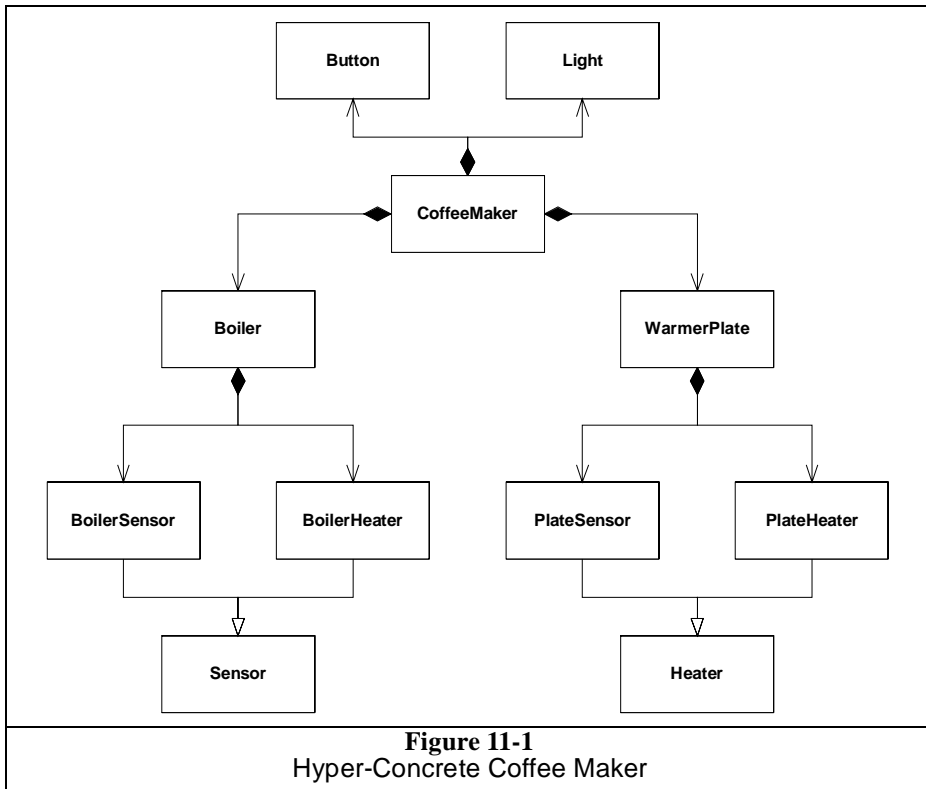

Vapor Classes

We can see how poorly partitioned this particular design is, if we consider the methods we might put in the class `Light`. Clearly the `Light` object just wants to be turned on or turned off. Thus we might put an `on()` and `off()` method in class `Light`. What would the implementation of those function look like? See Listing 11-2.

Listing 11-2 Light.java

```

public class Light {
    public void on() {
        CoffeeMakerAPI.api.
            setIndicatorState(CoffeeMakerAPI.INDICATOR_ON);
    }

    public void off() {
        CoffeeMakerAPI.api.
            setIndicatorState(CoffeeMakerAPI.INDICATOR_OFF);
    }
}

```

There are some peculiar things about class `Light`. First, it has no variables. This is odd since an object usually has some kind of state that it manipulates. What's more, the `on()` and `off()` methods simply delegate to the `setIndicatorState` method of the `CoffeeMakerAPI`. So apparently the `Light` class is nothing more than a call translator. It's not really doing anything useful.

This same reasoning can be applied to the `Button`, `Boiler`, and `WarmerPlate` classes. They are nothing more than adapters that translate a function call in one form to another. Indeed, they could be removed from the design altogether without changing any of the logic in the `CoffeeMaker` class. That class would simply have to call the `CoffeeMakerAPI` directly instead of through the adapters.

By considering the methods, and then the code, we have demoted these classes from the prominent position they hold in Figure 11-1, to mere place holders without much reason to exist. For this reason, I call them *Vapor Classes*.

Imaginary Abstraction

Notice the `Sensor` and `Heater` base classes in Figure 11-1. The previous section should have convinced you that their derivatives were mere vapor; but what about base classes themselves? On the surface they seem to make a lot of sense. And yet, there doesn't seem to be any place for them.

Abstractions are tricky things. We humans see them everywhere, but many are not appropriate to be turned into base classes. These, in particular, have no place in this design. We can see this by asking ourselves who uses them.

No class in the system actually makes use of the `Sensor` or `Heater` class. If nobody uses them, what reason do they have to exist? Sometimes we might tolerate a base class that nobody uses if it supplied some common code to the derivatives; but these bases have no code in them at all. At best their methods are abstract. Consider, for example, the `Heater` interface in Listing 11-3. A class with nothing but abstract functions and that no other class uses is officially useless.

Listing 11-3

Heater.java

```
public interface Heater {
    public void turnOn();
    public void turnOff();
}
```

The `Sensor` class (Listing 11-4) is worse! Like `Heater`, it has abstract methods and no users. What's worse is that the return value of its sole method is ambiguous. What does the `sense()` return? In the `BoilerSensor` it returns two possible values, But in `WarmerPlateSensor` it returns three possible values. In short, we cannot specify the contract of the `Sensor` in the interface. The best we can do is say that sensors may return ints. This is pretty weak.

Listing 11-4
Sensor.java

```
public interface Sensor {
    public int sense();
}
```

What really happened here is that we read through the specification, found a bunch of likely nouns, made some inferences about their relationships, and then created a UML diagram based on that reasoning. If we accepted these decisions as an architecture and implemented them the way they stand, then we'd wind up with an all powerful Coffee-Maker class surrounded by vaporous minions. We might as well program it in C!

God Classes

Everybody knows that god classes are a bad idea. We don't want to concentrate all the intelligence of a system into a single object, or a single function. One of the goals of OOD is the partitioning and distribution of behavior into many classes and many functions. It turns out, however, that many object models that appear to be distributed are really the abode of gods in disguise. Figure 11-1 is a prime example. At first glance it looks like there are lots of classes with interesting behavior. But as we drill down into the code that would implement those classes we find that only one of those classes, `CoffeeMaker`, has any interesting behavior, and the rest are all imaginary abstractions or vapor classes.

A Coffee Maker Solution

Solving the coffee maker problem is an interesting exercise in abstraction. Most developers new to OO find themselves quite surprised by the result.

The trick to solving this problem is to step back from the problem and separate the details from the essential nature of the problem. Forget about boilers, valves, heaters, sensors, and all the little details of the problem and concentrate on the underlying problem. What is that problem? The problem is: How do you make coffee?

How do you make coffee? The simplest, and most common solution to this problem, is to pour hot water over coffee grounds, and to collect the resulting infusion in some kind of vessel. Where do we get the hot water from? Let's call it a `HotWaterSource`. Where do we collect the coffee? Let's call it a `ContainmentVessel`².

Are these two abstractions really classes? Does a `HotWaterSource` have behavior that could be captured in software? Does a `ContainmentVessel` do something that software could control? If we think about the Mark IV unit, we could imagine the boiler, valve, and boiler sensor playing the role of the `HotWaterSource`. The `HotWaterSource` would be responsible for heating the water and delivering over the coffee grounds to drip

2. That name is particularly appropriate for the kind of coffee that I like to make.

into the `ContainmentVessel`. We could also imagine the warmer plate and its sensor playing the role of the `ContainmentVessel`. It would be responsible for keeping the contained coffee warm, and also for letting us know whether there was any coffee left in the vessel.

Crossed Wires

How would you capture the previous discussion in a UML diagram? Figure 11-2 shows one possible schema. `HotWaterSource` and `ContainmentVessel` are both represented as classes, and are associated by the flow of coffee.

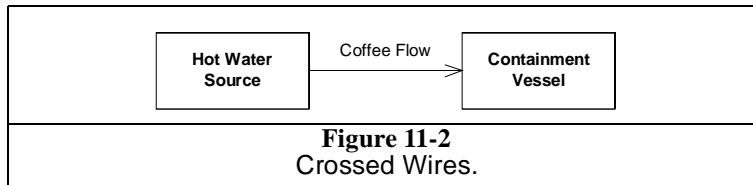

Figure 11-2
Crossed Wires.

The association shows an error that OO novices commonly make. The association is associated with something physical about the problem instead of with the control of software behavior. The fact that coffee flows from the `HotWaterSource` to the `ContainmentVessel` is completely irrelevant to the association between those two classes.

For example, what if the software in the `ContainmentVessel` told the `HotWaterSource` when to start and stop the flow of hot water into the vessel. This might be depicted as shown in Figure 11-3. Notice that the `ContainmentVessel` is sending the start message to the `HotWaterSource`. This means that the association in Figure 11-2 is backwards. `HotWaterSource` does not depend upon the `ContainmentVessel` at all. Rather, the `ContainmentVessel` depends upon the `HotWaterSource`.

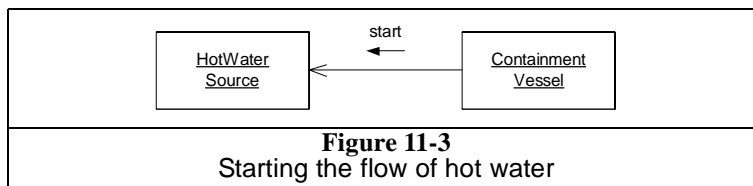

Figure 11-3
Starting the flow of hot water

The lesson here is simply this: Associations are the pathways through which messages are sent between objects. They have nothing to do with the flow of physical objects. The fact that hot water flows from the boiler to the pot does not mean that there should be an association from the `HotWaterSource` to the `ContainmentVessel`.

I call this particular mistake, “Crossed Wires” because the wiring between the classes has gotten crossed between the logical and physical domains.

The Coffee Maker User Interface

It should be clear that something is missing from our coffee maker model. We have a `HotWaterSource` and a `ContainmentVessel`, but we don't have any way for a human to interact with the system. Somewhere our system has to listen for commands from a human. Likewise the system must be able to report status to its human owners. Certainly the Mark IV had hardware dedicated to this purpose. The button and the light served as the user interface.

Thus, we'll add a `UserInterface` class to our coffee maker model. This gives us a triad of classes interacting to create coffee under the direction of a user.

Use Case 1: User pushes brew button.

OK, given these three classes, how to their instance communicate? Lets look at several use cases to see if we can find out what the behavior of these classes is.

Which one of our objects detects the fact that the user has pressed the brew button? Clearly it must be the `UserInterface` object. What should this object do when the brew button is pushed?

Our goal is to start the flow of hot water. However, before we can do that, we'd better make sure that the `ContainmentVessel` is ready to accept coffee. We'd also better make sure that the `HotWaterSource` is ready. If we think about the MarkIV, we're making sure that the boiler is full, and that the pot is empty and in place on the warmer.

So the first thing our `UserInterface` object does is to send message to the `HotWaterSource` and the `ContainmentVessel` to see if they are ready. This is shown in Figure 11-4.

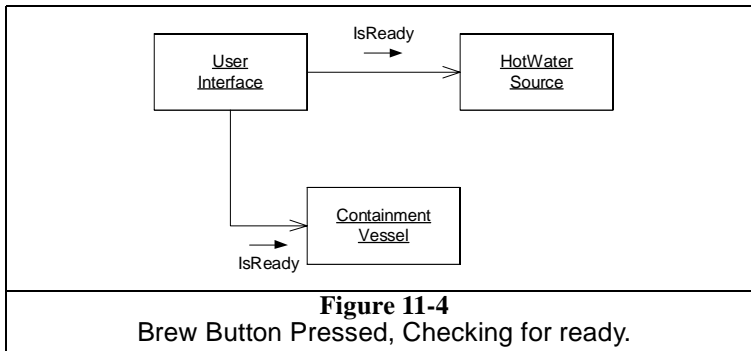

If either of these queries returns false, then we refuse to start brewing coffee. The `UserInterface` object can take care of letting the user know that his request was denied. In the MarkIV case, we might flash the light a few times.

If both queries return true, then we need to start the flow of hot water. Probably the `UserInterface` object should send a `Start` message to the `HotWaterSource`. The `HotWaterSource` will then start doing whatever it needs to do to get hot water flowing. In the case of the MarkIV, it will close the valve and turn on the boiler. Figure 11-5 shows the completed scenario.

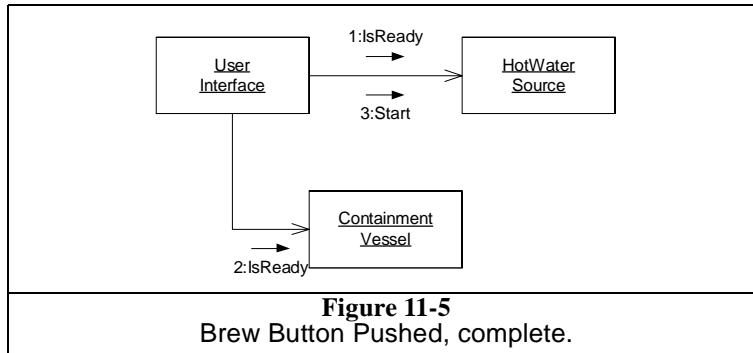

Use Case 2: Containment Vessel not Ready.

In the Mark IV we know that the user can take the pot off the warmer while coffee is flowing. Which one of our objects would detect the fact that the pot had been removed? Certainly it would be the `ContainmentVessel`. The requirements for the MarkIV tell us that we need to stop the flow of coffee when this happens. Thus the `ContainmentVessel` must be able to tell the `HotWaterSource` to stop sending hot water. Likewise, it needs to be able to tell it to start again when the pot is replaced. Figure 11-6 adds the new methods.

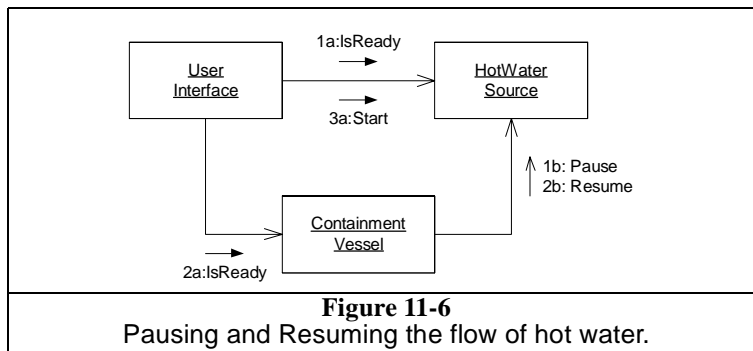

Use Case 3: Brewing Complete.

At some point we will be done brewing coffee, and we'll have to turn off the flow of hot water. Which one of our objects knows when brewing is complete? In the MarkIV case the

sensor in the boiler tells us that the boiler is empty. So our `HotWaterSource` would detect this. However, it's not hard to envision a coffee maker in which the `ContainmentVessel` would be the one to detect that brewing was done. For example, what if our coffee maker was plumbed into the water mains and therefore had an infinite supply of water. What if the water was heated by an intense microwave generator³ as it flowed through the pipes into a thermally isolated vessel. What if that vessel had a spigot from which users got their coffee. In this case it would be a sensor in the vessel that would know that it was full, and that hot water should be shut off.

The point is that in the abstract domain of the `HotWaterSource` and `ContainmentVessel`, neither is a particular compelling candidate for detecting completion of the brew. My solution to that is to ignore the issue. I'll assume that either object can tell the others that brewing is complete.

Which objects in our model need to know that brewing is complete? Certainly the `UserInterface` needs to know since, in the Mark IV case, it must turn the light on. It should also be clear that the `HotWaterSource` needs to know that brewing is over, because it'll need to stop the flow of hot water. In the Mark IV case it'll shut down the boiler and open the valve. Does the `ContainmentVessel` need to know that brewing is complete? Is there anything special that the `ContainmentVessel` needs to do, or to keep track of, once the brewing is complete? In the Mark IV case it's going to detect an empty pot being put back on the plate, signalling that the user has poured all the coffee. This causes the Mark IV to turn the light out. So, yes, the `ContainmentVessel` needs to know that brewing is complete. Indeed, the same argument can be used to say that the `UserInterface` should send the `Start` message to the `ContainmentVessel` when brewing starts. Figure 11-7 shows the new messages. Note that I've shown that either `HotWaterSource` or `ContainmentVessel` can send the `Done` message.

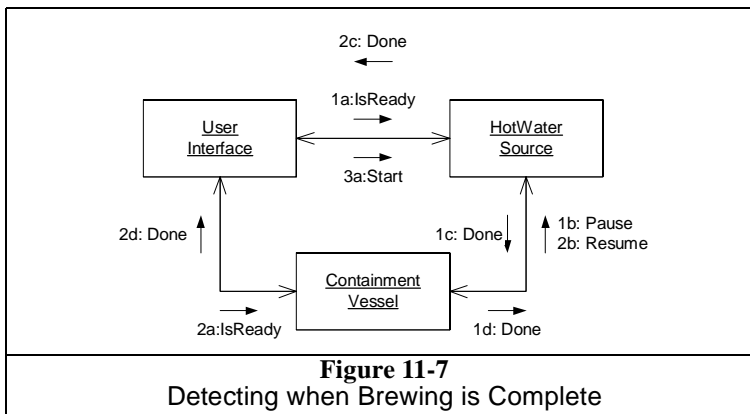

3. OK...I'm having a bit of fun. But..what if?

Use Case 4: Coffee all gone.

The Mark IV shuts off the light when brewing is complete *and* an empty pot is placed on the plate. Clearly, in our object model, it is the `ContainmentVessel` that should detect this. It will have to send a `Complete` message to the `UserInterface`. Figure 11-8 shows the completed collaboration diagram.

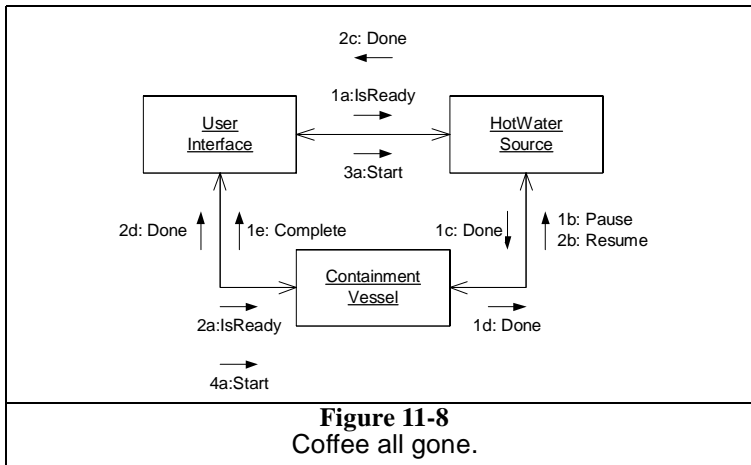

From this diagram we can draw a class diagram with all the associations intact. This diagram holds no surprises. You can see it in Figure 11-9.

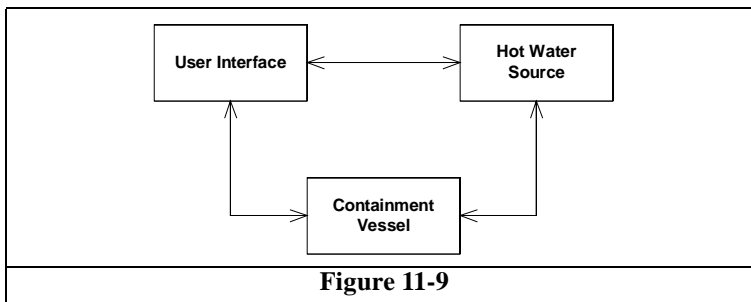

Implementing the Abstract Model.

Our object model is reasonably well partitioned. We have three distinct areas of responsibility, and each seems to be sending and receiving messages in a balanced way. There does not appear to be a god object anywhere. Nor do there appear to be any vapor classes.

So far, so good; but how do we implement the Mark IV in this structure? Do we just implement the methods of these three classes to invoke the `CoffeeMakerAPI`? This

would be a real shame! We've captured the essence of what it takes to make coffee. It would be pitifully poor design if we were to now tie that essence to the Mark IV.

In fact, I'm going to make a rule right now. None of the three classes we have created must ever know anything about the Mark IV. This is the Dependency Inversion Principle (DIP). We are not going to allow the high level coffee making policy of this system to depend upon the low level implementation.

OK, then how will we create the Mark IV implementation? Lets look at all the use cases again; but this time, lets look at them from the Mark IV point of view.

Use Case 1. User pushes Brew Button (Mark IV)

Looking at our model, how does the `UserInterface` know that the brew button has been pushed? Clearly it must call the `CoffeeMakerAPI.getBrewButtonStatus()` function. Where should it call this function? We've already decreed that the `UserInterface` class itself cannot know about the `CoffeeMakerAPI`. So where does this call go?

We'll apply the DIP and put the call in a derivative of `UserInterface`. See Figure 11-10 for details.

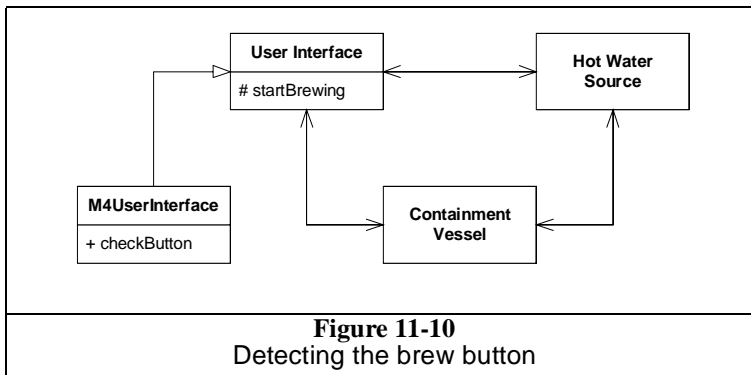

We've derived `M4UserInterface` from `UserInterface`, and we've put a `checkButton()` method in `M4UserInterface`. When this function is called, it will call the `CoffeeMakerAPI.getBrewButtonStatus()` function. If the button has been pressed, it will invoke the protected `startBrewing()` method of `UserInterface`. Listing 11-5 and Listing 11-6 show how this would be coded.

Listing 11-5

M4UserInterface.java

```

public class M4UserInterface extends UserInterface {
    private void checkButton() {
        int buttonStatus =
            CoffeeMakerAPI.api.getBrewButtonStatus();
        if (buttonStatus == CoffeeMakerAPI.BREW_BUTTON_PUSHED) {
            startBrewing();
        }
    }
}
  
```

Listing 11-5 (Continued)
M4UserInterface.java

```

    }
}

```

Listing 11-6
UserInterface.java

```

public class UserInterface {
    private HotWaterSource hws;
    private ContainmentVessel cv;

    public void done() {}
    public void complete() {}
    protected void startBrewing() {
        if (hws.isReady() && cv.isReady()) {
            hws.start();
            cv.start();
        }
    }
}

```

You might be wondering why I created the protected `startBrewing()` method at all. Why didn't I just call the `start()` functions from `M4UserInterface`. The reason is simple, but significant. The `isReady()` tests, and the consequential calls to the `start()` methods of the `HotWaterSource` and the `ContainmentVessel` are high level policy that the `UserInterface` class should possess. That code is valid irrespective of whether or not we are implementing a Mark IV and should therefore not be coupled to the Mark IV derivative. You will see me make this same distinction over and over again in this example. I keep as much code as I can in the high level classes. The only code I put into the derivatives is code that is directly, and inextricably, associated with the Mark IV.

Implementing the `isReady()` functions.

How are the `isReady()` method of `HotWaterSource` and `ContainmentVessel` implemented? It should be clear that these are really just abstract methods, and that these classes are therefore abstract classes. The corresponding derivatives `M4HotWaterSource` and `M4ContainmentVessel` will implement them by calling the appropriate `CoffeeMaker-API` functions. Figure 11-11 shows the new structure, and Listing 11-7 and Listing 11-8 show the implementation of the two derivatives.

Notice that in the UML of Figure 11-11 I am using a shorthand to represent abstract classes and methods. I place the symbol: `{A}` near the entity that I am denoting as abstract. This is my own shorthand convention. It's much more convenient than having to write out `{abstract}` all the time.

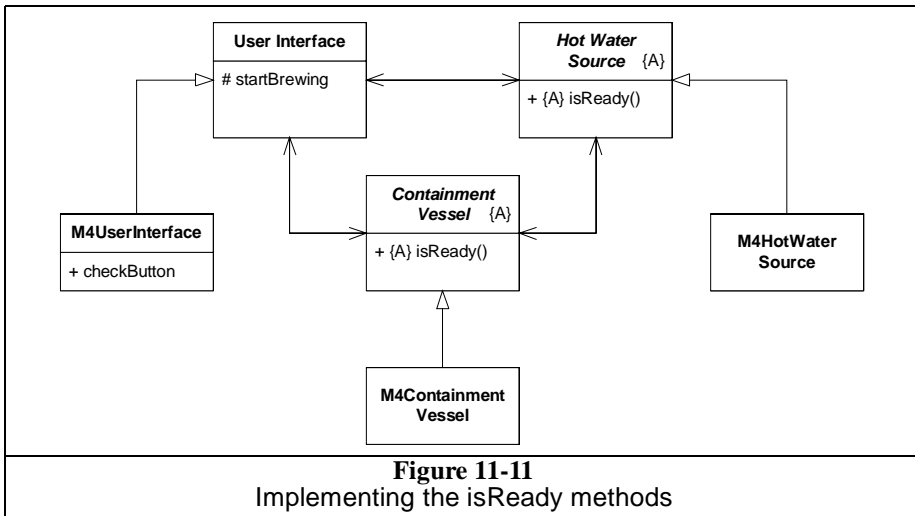
**Listing 11-7****M4HotWaterSource.java**

```

public class M4HotWaterSource extends HotWaterSource {
    public boolean isReady() {
        int boilerStatus =
            CoffeeMakerAPI.api.getBoilerStatus();
        return boilerStatus == CoffeeMakerAPI.BOILER_NOT_EMPTY;
    }
}

```

Listing 11-8**M4ContainmentVessel.java**

```

public class M4ContainmentVessel extends ContainmentVessel {
    public boolean isReady() {
        int plateStatus =
            CoffeeMakerAPI.api.getWarmerPlateStatus();
        return plateStatus == CoffeeMakerAPI.POT_EMPTY;
    }
}

```

Implementing the start () functions.

The start () method of HotWaterSource is just an abstract method that is implemented by M4HotWaterSource to invoke the CoffeeMakerAPI functions that close the valve and turn on the boiler. As I wrote these functions I began to get tired of all the CoffeeMakerAPI.api.XXX structures I was writing, so I did a little refactoring at the same time. The result is in Listing 11-9.

Listing 11-9
M4HotWaterSource.java

```
public class M4HotWaterSource extends HotWaterSource {
    CoffeeMakerAPI api;

    public M4HotWaterSource(CoffeeMakerAPI api) {
        this.api = api;
    }

    public boolean isReady() {
        int boilerStatus = api.getBoilerStatus();
        return boilerStatus == api.BOILER_NOT_EMPTY;
    }

    public void start() {
        api.setReliefValveState(api.VALVE_CLOSED);
        api.setBoilerState(api.BOILER_ON);
    }
}
```

The `start()` method for the `ContainmentVessel` is a little more interesting. The only action that the `M4ContainmentVessel` needs to take is to remember the brewing state of the system. As we'll see later, this will allow it to respond correctly when pots are placed on, or removed from, the plate. Listing 11-10 shows the code.

Listing 11-10
M4ContainmentVessel.java

```
public class M4ContainmentVessel extends ContainmentVessel {
    private CoffeeMakerAPI api;
    private boolean isBrewing;

    public M4ContainmentVessel(CoffeeMakerAPI api) {
        this.api = api;
        isBrewing = false;
    }

    public boolean isReady() {
        int plateStatus = api.getWarmerPlateStatus();
        return plateStatus == api.POT_EMPTY;
    }

    public void start() {
        isBrewing = true;
    }
}
```

How does `M4UserInterface.checkBox` get called?

This is an interesting point. How does the flow of control ever get to a place at which the `CoffeeMakerAPI.getBrewButtonStatus()` function can be called. For that matter, how does the flow of control get to where *any* of the sensors can be detected?

Many of the teams who try to solve this problem get completely hung up on this point. Some don't want to assume that there's a multi-threading operating system in the

coffee maker, and so they want to use a polling approach to the sensors. Others want to put multi-threading in so that they don't have to worry about polling. I've seen this particular argument go back and forth for an hour or more in some teams.

The mistake that these teams are making (which I eventually point out to them after letting them sweat a bit) is that the choice between threading and polling is completely irrelevant. This decision can be made at the very last minute without harm to the design. Therefore it is always best to assume that messages can be sent asynchronously, as though there were independent threads, and then put the polling or threading in at the last minute.

The design so far has assumed that somehow the flow of control will asynchronously get into the `M4UserInterface` object so that it can call `CoffeeMakerAPI.getBrewButtonStatus()`. Now let's assume that we are working in a very minimal JVM that does not support threading. This means we're going to have to poll. How can we make this work?

Consider the `Pollable` interface in Listing 11-11. This interface has nothing but a `poll()` method. Now, what if `M4UserInterface` implemented this interface? What if the `main()` program hung in a hard loop just calling this method over and over again? Then the flow of control would continuously be reentering `M4UserInterface` and we could detect the brew button.

Listing 11-11
Pollable.java

```
public interface Pollable {
    public void poll();
}
```

Indeed, we can repeat this pattern for all three of the M4 derivatives. Each has its own sensors it needs to check. So, as shown in Figure 11-12, we can derive all of the M4 derivatives from `Pollable` and call them all from `main()`.

Listing 11-12 shows what the main function might look like. It is placed in a class called `CoffeeMaker`. The `main()` function creates the implemented version of the `api`, and then creates the three M4 components. It calls `init()` functions to wire the components up to each other. Finally it hangs in an infinite loop calling `poll()` on each of the components in turn.

Now it should be clear how the `M4UserInterface.checkButton()` function gets called. Indeed, it should be clear that this function is really not called `checkButton()`. It is called `poll()`. Listing 11-13 shows what `M4UserInterface` look like now.

Completing the Coffee Maker

The reasoning used in the previous sections can be repeated for each of the other components of the coffee maker. The result is shown in Listing 11-14 through Listing 11-21.

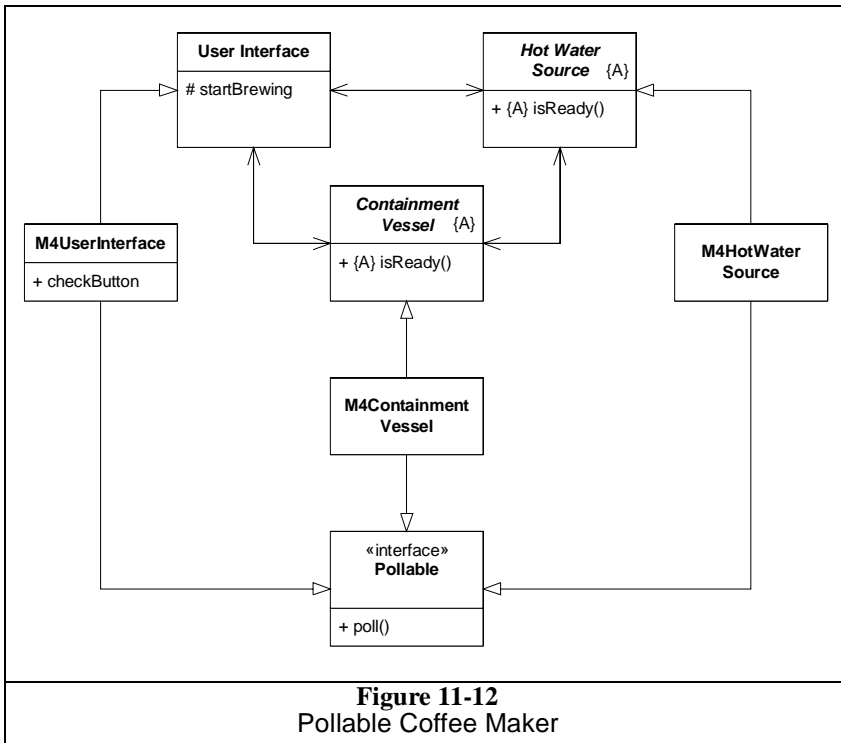

Listing 11-12
CoffeeMaker.java

```

public class CoffeeMaker {
    public static void main(String[] args) {
        CoffeeMakerAPI api = new M4CoffeeMakerAPIImplementation();

        M4UserInterface ui = new M4UserInterface(api);
        M4HotWaterSource hws = new M4HotWaterSource(api);
        M4ContainmentVessel cv = new M4ContainmentVessel(api);

        ui.init(hws,cv);
        hws.init(ui,cv);
        cv.init(ui,hws);

        while(true) {
            ui.poll();
            hws.poll();
            cv.poll();
        }
    }
}
  
```

Listing 11-13
M4UserInterface.java

```
public class M4UserInterface extends UserInterface
    implements Pollable {
    private CoffeeMakerAPI api;
    private HotWaterSource hws;
    private ContainmentVessel cv;

    public void init(HotWaterSource hws, ContainmentVessel cv) {
        this.hws = hws;
        this.cv = cv;
    }

    public M4UserInterface(CoffeeMakerAPI api) {
        this.api = api;
    }

    private void poll() {
        int buttonStatus = api.getBrewButtonStatus();
        if (buttonStatus == api.BREW_BUTTON_PUSHED) {
            startBrewing();
        }
    }
}
```

The Benefits of this design.

Despite the trivial nature of the problem, this design shows some very nice characteristics. Figure 11-13 shows the structure. I have drawn a line around the three abstract classes. These are the classes that hold the high level policy of the coffee maker. Notice that all dependencies that cross the line point inwards. Nothing inside the line depends upon anything outside. Thus, the abstractions are completely separated from the details.

The abstract classes know nothing of buttons, lights, valves, sensors, nor any other of the detailed elements of the coffee maker. By the same token, the derivatives are dominated by those details.

Note that the three abstract classes could be reused to make many different kinds of coffee machines. We could easily use them in a coffee machine that is connected to the water mains and uses a tank and spigot. It seems likely that we could also use them for a coffee vending machine. Indeed, I think we could use it in an automatic tea brewer or even a chicken soup maker. This segregation between high level policy and detail is the essence of object oriented design.

How did I really come up with this design?

I did not just sit down one day and develop this design in a nice straightfoward manner. Indeed, my very first design for the coffee maker looked much more like Figure 11-1. However, I have written about this problem many times, and have used it as an exercise while teaching class after class. So this design has been refined over time.

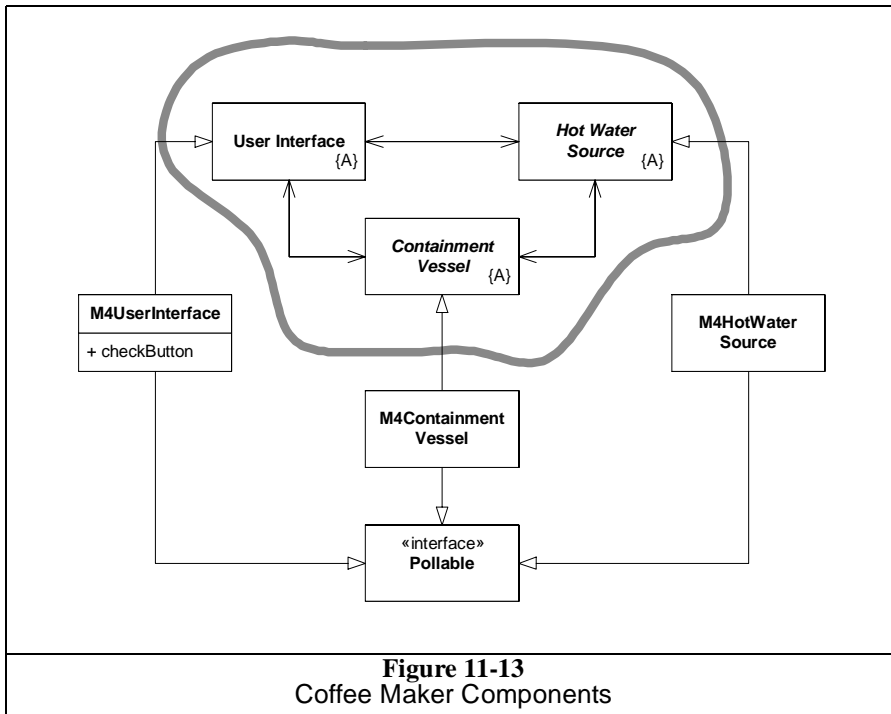

The code you see below was created, test first, using unit tests in Listing 11-22. I created the code based upon the structure in Figure 11-13, but put it together incrementally, one failing test case at a time.⁴

I am not convince that the test cases are complete. If this were more than an example program, I'd do a more exhaustive analysis on the test cases. However, I felt that such an analysis would have been overkill for this book.

Listing 11-14
UserInterface.java

```
public abstract class UserInterface {
    private HotWaterSource hws;
    private ContainmentVessel cv;
    protected boolean isComplete;

    public UserInterface() {
        isComplete = true;
    }

    public void init(HotWaterSource hws, ContainmentVessel cv) {
        this.hws = hws;
        this.cv = cv;
    }
}
```

4. See *Test Driven Development*, Kent Beck, Addison Wesley, 2002

Listing 11-14 (Continued)
UserInterface.java

```

public void complete() {
    isComplete = true;
    completeCycle();
}

protected void startBrewing() {
    if (hws.isReady() && cv.isReady()) {
        isComplete = false;
        hws.start();
        cv.start();
    }
}

public abstract void done();
public abstract void completeCycle();
}

```

Listing 11-15
M4UserInterface.java

```

public class M4UserInterface extends UserInterface
    implements Pollable {
    private CoffeeMakerAPI api;

    public M4UserInterface(CoffeeMakerAPI api) {
        this.api = api;
    }

    public void poll() {
        int buttonStatus = api.getBrewButtonStatus();
        if (buttonStatus == api.BREW_BUTTON_PUSHED) {
            startBrewing();
        }
    }

    public void done() {
        api.setIndicatorState(api.INDICATOR_ON);
    }

    public void completeCycle() {
        api.setIndicatorState(api.INDICATOR_OFF);
    }
}

```

Listing 11-16
HotWaterSource.java

```

public abstract class HotWaterSource {
    private UserInterface ui;
    private ContainmentVessel cv;
    protected boolean isBrewing;

    public HotWaterSource() {
        isBrewing = false;
    }
}

```

Listing 11-16 (Continued)
HotWaterSource.java

```

public void init(UserInterface ui, ContainmentVessel cv) {
    this.ui = ui;
    this.cv = cv;
}

public void start() {
    isBrewing = true;
    startBrewing();
}

public void done() {
    isBrewing = false;
}

protected void declareDone() {
    ui.done();
    cv.done();
    isBrewing = false;
}

public abstract boolean isReady();
public abstract void startBrewing();
public abstract void pause();
public abstract void resume();
}

```

Listing 11-17
M4HotWaterSource.java

```

public class M4HotWaterSource extends HotWaterSource
    implements Pollable {
    private CoffeeMakerAPI api;

    public M4HotWaterSource(CoffeeMakerAPI api) {
        this.api = api;
    }

    public boolean isReady() {
        int boilerStatus = api.getBoilerStatus();
        return boilerStatus == api.BOILER_NOT_EMPTY;
    }

    public void startBrewing() {
        api.setReliefValveState(api.VALVE_CLOSED);
        api.setBoilerState(api.BOILER_ON);
    }

    public void poll() {
        int boilerStatus = api.getBoilerStatus();
        if (isBrewing) {
            if (boilerStatus == api.BOILER_EMPTY) {
                api.setBoilerState(api.BOILER_OFF);
                api.setReliefValveState(api.VALVE_CLOSED);
                declareDone();
            }
        }
    }
}

```

Listing 11-17 (Continued)
M4HotWaterSource.java

```

    }
}

public void pause() {
    api.setBoilerState(api.BOILER_OFF);
    api.setReliefValveState(api.VALVE_OPEN);
}

public void resume() {
    api.setBoilerState(api.BOILER_ON);
    api.setReliefValveState(api.VALVE_CLOSED);
}
}

```

Listing 11-18
ContainmentVessel.java

```

public abstract class ContainmentVessel {
    private UserInterface ui;
    private HotWaterSource hws;
    protected boolean isBrewing;
    protected boolean isComplete;

    public ContainmentVessel() {
        isBrewing = false;
        isComplete = true;
    }

    public void init(UserInterface ui, HotWaterSource hws) {
        this.ui = ui;
        this.hws = hws;
    }

    public void start() {
        isBrewing = true;
        isComplete = false;
    }

    public void done() {
        isBrewing = false;
    }

    protected void declareComplete() {
        isComplete = true;
        ui.complete();
    }

    protected void containerAvailable() {
        hws.resume();
    }

    protected void containerUnavailable() {
        hws.pause();
    }

    public abstract boolean isReady();
}

```

Listing 11-18 (Continued)
 ContainmentVessel.java

```
}

```

Listing 11-19
 M4ContainmentVessel.java

```
public class M4ContainmentVessel extends ContainmentVessel
    implements Pollable {
    private CoffeeMakerAPI api;
    private int lastPotStatus;

    public M4ContainmentVessel(CoffeeMakerAPI api) {
        this.api = api;
        lastPotStatus = api.POT_EMPTY;
    }

    public boolean isReady() {
        int plateStatus = api.getWarmerPlateStatus();
        return plateStatus == api.POT_EMPTY;
    }

    public void poll() {
        int potStatus = api.getWarmerPlateStatus();
        if (potStatus != lastPotStatus) {
            if (isBrewing) {
                handleBrewingEvent(potStatus);
            } else if (isComplete == false) {
                handleIncompleteEvent(potStatus);
            }
            lastPotStatus = potStatus;
        }
    }

    private void handleBrewingEvent(int potStatus) {
        if (potStatus == api.POT_NOT_EMPTY) {
            containerAvailable();
            api.setWarmerState(api.WARMER_ON);
        } else if (potStatus == api.WARMER_EMPTY) {
            containerUnavailable();
            api.setWarmerState(api.WARMER_OFF);
        } else { // potStatus == api.POT_EMPTY
            containerAvailable();
            api.setWarmerState(api.WARMER_OFF);
        }
    }

    private void handleIncompleteEvent(int potStatus) {
        if (potStatus == api.POT_NOT_EMPTY) {
            api.setWarmerState(api.WARMER_ON);
        } else if (potStatus == api.WARMER_EMPTY) {
            api.setWarmerState(api.WARMER_OFF);
        } else { // potStatus == api.POT_EMPTY
            api.setWarmerState(api.WARMER_OFF);
            declareComplete();
        }
    }
}
```

Listing 11-19 (Continued)
M4ContainmentVessel.java

```
}
}
```

Listing 11-20
Pollable.java

```
public interface Pollable {
    public void poll();
}
```

Listing 11-21
CoffeeMaker.java

```
public class CoffeeMaker {
    public static void main(String[] args) {
        CoffeeMakerAPI api = new M4CoffeeMakerAPIImplementation();

        M4UserInterface ui = new M4UserInterface(api);
        M4HotWaterSource hws = new M4HotWaterSource(api);
        M4ContainmentVessel cv = new M4ContainmentVessel(api);

        ui.init(hws,cv);
        hws.init(ui,cv);
        cv.init(ui,hws);

        while(true) {
            ui.poll();
            hws.poll();
            cv.poll();
        }
    }
}
```

Listing 11-22
TestCoffeeMaker.java

```
import junit.framework.TestCase;
import junit.swingui.TestRunner;

class CoffeeMakerStub implements CoffeeMakerAPI {
    public boolean buttonPressed;
    public boolean lightOn;
    public boolean boilerOn;
    public boolean valveClosed;
    public boolean plateOn;
    public boolean boilerEmpty;
    public boolean potPresent;
    public boolean potNotEmpty;

    public CoffeeMakerStub() {
        buttonPressed = false;
        lightOn = false;
        boilerOn = false;
        valveClosed = true;
        plateOn = false;
        boilerEmpty = true;
        potPresent = true;
    }
}
```

Listing 11-22 (Continued)
TestCoffeeMaker.java

```
    potNotEmpty = false;
}

public int getWarmerPlateStatus() {
    if (!potPresent)
        return WARMER_EMPTY;
    else if (potNotEmpty)
        return POT_NOT_EMPTY;
    else
        return POT_EMPTY;
}

public int getBoilerStatus() {
    return boilerEmpty ? BOILER_EMPTY : BOILER_NOT_EMPTY;
}

public int getBrewButtonStatus() {
    if (buttonPressed) {
        buttonPressed = false;
        return BREW_BUTTON_PUSHED;
    } else {
        return BREW_BUTTON_NOT_PUSHED;
    }
}

public void setBoilerState(int boilerStatus) {
    boilerOn = boilerStatus == BOILER_ON;
}

public void setWarmerState(int warmerState) {
    plateOn = warmerState == WARMER_ON;
}

public void setIndicatorState(int indicatorState) {
    lightOn = indicatorState == INDICATOR_ON;
}

public void setReliefValveState(int reliefValveState) {
    valveClosed = reliefValveState == VALVE_CLOSED;
}
}

public class TestCoffeeMaker extends TestCase {
    public static void main(String[] args) {
        TestRunner.main(new String[]{"TestCoffeeMaker"});
    }

    public TestCoffeeMaker(String name) {
        super(name);
    }

    private M4UserInterface ui;
    private M4HotWaterSource hws;
    private M4ContainmentVessel cv;
    private CoffeeMakerStub api;
```

Listing 11-22 (Continued)
TestCoffeeMaker.java

```
public void setUp() throws Exception {
    api = new CoffeeMakerStub();
    ui = new M4UserInterface(api);
    hws = new M4HotWaterSource(api);
    cv = new M4ContainmentVessel(api);
    ui.init(hws, cv);
    hws.init(ui, cv);
    cv.init(ui, hws);
}

private void poll() {
    ui.poll();
    hws.poll();
    cv.poll();
}

public void tearDown() throws Exception {
}

public void testInitialConditions() throws Exception {
    poll();
    assert(api.boilerOn == false);
    assert(api.lightOn == false);
    assert(api.plateOn == false);
    assert(api.valveClosed == true);
}

public void testStartNoPot() throws Exception {
    poll();
    api.buttonPressed = true;
    api.potPresent = false;
    poll();
    assert(api.boilerOn == false);
    assert(api.lightOn == false);
    assert(api.plateOn == false);
    assert(api.valveClosed == true);
}

public void testStartNoWater() throws Exception {
    poll();
    api.buttonPressed = true;
    api.boilerEmpty = true;
    poll();
    assert(api.boilerOn == false);
    assert(api.lightOn == false);
    assert(api.plateOn == false);
    assert(api.valveClosed == true);
}

public void testGoodStart() throws Exception {
    normalStart();
    assert(api.boilerOn == true);
    assert(api.lightOn == false);
    assert(api.plateOn == false);
}
```

Listing 11-22 (Continued)
TestCoffeeMaker.java

```
    assert(api.valveClosed == true);
}

private void normalStart() {
    poll();
    api.boilerEmpty = false;
    api.buttonPressed = true;
    poll();
}

public void testStartedPotNotEmpty() throws Exception {
    normalStart();
    api.potNotEmpty = true;
    poll();
    assert(api.boilerOn == true);
    assert(api.lightOn == false);
    assert(api.plateOn == true);
    assert(api.valveClosed == true);
}

public void testPotRemovedAndReplacedWhileEmpty()
throws Exception {
    normalStart();
    api.potPresent = false;
    poll();
    assert(api.boilerOn == false);
    assert(api.lightOn == false);
    assert(api.plateOn == false);
    assert(api.valveClosed == false);
    api.potPresent = true;
    poll();
    assert(api.boilerOn == true);
    assert(api.lightOn == false);
    assert(api.plateOn == false);
    assert(api.valveClosed == true);
}

public void testPotRemovedWhileNotEmptyAndReplacedEmpty()
throws Exception {
    normalFill();
    api.potPresent = false;
    poll();
    assert(api.boilerOn == false);
    assert(api.lightOn == false);
    assert(api.plateOn == false);
    assert(api.valveClosed == false);
    api.potPresent = true;
    api.potNotEmpty = false;
    poll();
    assert(api.boilerOn == true);
    assert(api.lightOn == false);
    assert(api.plateOn == false);
    assert(api.valveClosed == true);
}

private void normalFill() {
```

Listing 11-22 (Continued)
TestCoffeeMaker.java

```
        normalStart();
        api.potNotEmpty = true;
        poll();
    }

    public void testPotRemovedWhileNotEmptyAndReplacedNotEmpty()
    throws Exception {
        normalFill();
        api.potPresent = false;
        poll();
        api.potPresent = true;
        poll();
        assert(api.boilerOn == true);
        assert(api.lightOn == false);
        assert(api.plateOn == true);
        assert(api.valveClosed == true);
    }

    public void testBoilerEmptyPotNotEmpty() throws Exception {
        normalBrew();
        assert(api.boilerOn == false);
        assert(api.lightOn == true);
        assert(api.plateOn == true);
        assert(api.valveClosed == true);
    }

    private void normalBrew() {
        normalFill();
        api.boilerEmpty = true;
        poll();
    }

    public void testBoilerEmptiesWhilePotRemoved()
    throws Exception {
        normalFill();
        api.potPresent = false;
        poll();
        api.boilerEmpty = true;
        poll();
        assert(api.boilerOn == false);
        assert(api.lightOn == true);
        assert(api.plateOn == false);
        assert(api.valveClosed == true);
        api.potPresent = true;
        poll();
        assert(api.boilerOn == false);
        assert(api.lightOn == true);
        assert(api.plateOn == true);
        assert(api.valveClosed == true);
    }

    public void testEmptyPotReturnedAfter() throws Exception {
        normalBrew();
        api.potNotEmpty = false;
        poll();
        assert(api.boilerOn == false);
    }
}
```

Listing 11-22 (Continued)**TestCoffeeMaker.java**

```
    assert(api.lightOn == false);
    assert(api.plateOn == false);
    assert(api.valveClosed == true);
  }
}
```

SMC Remote Service: Case Study

Some time ago I decided to write a pair of programs that would allow users to compile SMC¹ input files remotely. On the client side the program would be invoked just like SMC. However, instead of compiling a state map file it would take the file and ship it across the internet to a central server. This server would compile the state map file into Java or C++ and then ship the resulting files back to the client. Except for the network delay, the remote user would not see much difference between compiling locally and compiling remotely.

The reason to do this is to get some idea of how many people are using SMC, and how often they are using it. Another reason is to make sure that all SMC users are using the most current version of the compiler.

Caveat Emptor

In this chapter I describe these programs using text, UML, and code. I do this to show you how UML and code are related, and the many options for documenting a system using UML. However, you should *not* take this chapter as a recommendation for how systems should be documented. Indeed I am purposely over-documenting this software so that I can show you all the various UML diagrams in a well controlled context.

Please know that these programs were designed without the use of any UML at all. They started from very humble beginnings and were refactored through no less than 20 revisions to get to where they are in this book.² At no point did I need or want a UML diagram to help me with that design. Nor do I think that the use of UML diagrams would have made the development more efficient or resulted in a superior design.

-
1. See “SMC” on page 114
 2. I am thinking about publishing a book that chronicles that development. It would have one chapter for each revision of the system, showing how it evolved from state to state.

If I were documenting this software for other developers to maintain, I would certainly create some UML diagrams to show them. However, I would not create anywhere near the amount of UML diagrams I am going to show here. Again, what you see here is *severely* over documented.

You have been warned.

Unit Tests.

Among the best documents for describing a software system are the unit tests for that system³. Usually I would show you the unit tests first, before showing you the production code. However, in this case I am trying to expose UML, not the system itself. So I have put the tests at the end of the chapter, instead of giving them the prominence that they deserve. Still, you'll likely find that you'll understand the code much better if you read through those tests, so I strongly recommend looking through them.

The SMCRremote System.

Figure 12-1 shows the physical deployment of the system. There are two executable programs, each contained within its own node. The two programs communicate using a socket connection.

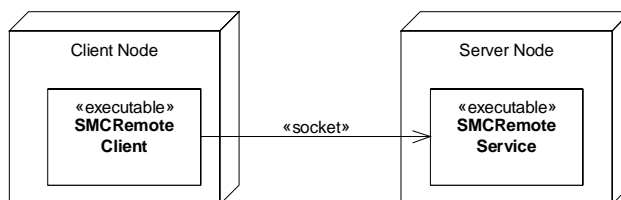

Figure 12-1
Deployment

SMCRremoteClient

First, let's look at the client side of the program. The next several pages will present text, diagrams, and code that show how the `SMCRremoteClient` works, and how it is structured.

3. [TDD2002], p???

SMCRemoteClient Command Line

Users invoke the `SMCRemoteClient` for one of two purposes.

- To register to use the `SMCRemote` system.
- To use the `SMCRemote` system to compile a `.sm` file.

The difference between the two is specified on the command line. To register to use `SMCRemote` the user types the following:

```
SMCRemote -r <email-address>
```

The `SMCRemote` registers the email address, calculates a password, and emails that password back to the email address. From then on, the user will use that email address and password in order to run compiles.

To run a compile the user types the following:

```
SMCRemote -u <email-address> -w <password> <file>
```

This command sends the file to the remote compiler. The remote compiler verifies that the email and password are valid. Then it compiles the file. The compiled file(s) are then sent back to the client and written in the user's directory. Any `stdout` or `stderr` messages produced by the compiler are also sent back to the client and will appear on the user's console.

There are other command line options as well.

- `-p <port>` - specifies the port number of the remote server
- `-h <host>` - specifies the hostname of the remote server
- `-g <generator>` - for a compile, specifies the code generator to use. `<generator>` may be either `java` or `C++`.
- `-v` - Verbose output. Prints lots of messages on the console to tell you what kind of progress and errors the `SMCRemoteClient` has encountered.

SMCRemote Communication Protocols

The two different functions of the `SMCRemoteClient` use two different communications protocols. The protocol for registration is shown in Figure 12-2, and the protocol for compilation is shown in Figure 12-3.

Both protocols begin with the client creating a connection to the server. The server responds with a simple identification string that includes the `SMCRemoteServer`'s version number. Then it sends a message-of-the-day, if one exists. The client will print that message on its console.

Registration is simply a matter of sending the email address from the client to the server. In the normal case the server generates a password for the user, creates a user record, and then emails the password to the email address. The server sends a response back to the client telling the user that he'll find his password in an email message.

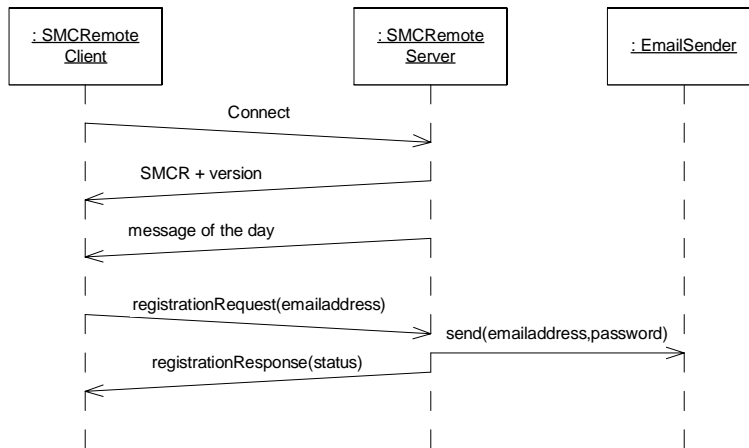

Figure 12-2
Registration Protocol

Compilation is a bit more complex. After the initial connection, the client collects the email and password from the command line and issues a login request to the server. The server validates the email and password and sends a login response back. If the response is positive, then the client gathers up the file to compile and sends it to the server. The server runs the compiler, gathers up the output files and the `stdout` and `stderr` streams, and sends them back to the client. The client writes the output files in the user's directory and emits the `stdout` and `stderr` streams on his console.⁴

4. Readers experienced with distributed systems should be shaking their heads in frustration. By creating a separate transaction for login, I have violated the old maxim "Round trips are the enemy." It would be much more efficient to piggyback the login protocol on top of the compile protocol. The `compileFile` message could carry the email and password, and the `compileResults` message could carry back a login failure response. I didn't do this for two reasons. First, none of my trials indicated that the round trip time was significant. Second, this program was written for teaching purposes, and I wanted a two stage protocol in the example.

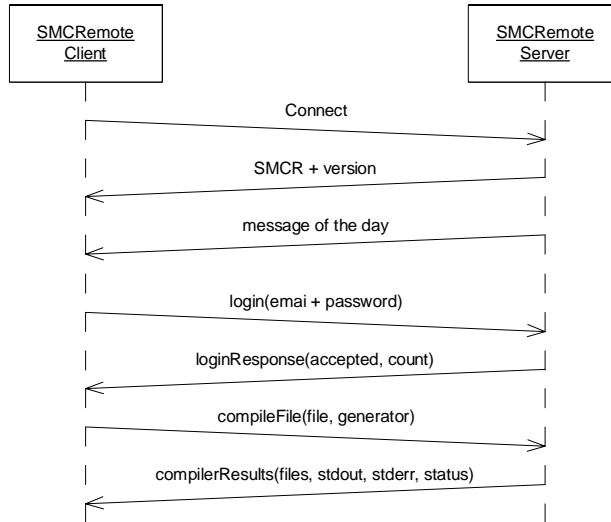

Figure 12-3
Compile protocol

SMCRremoteClient

The structure of the `SMCRremoteClient` program is shown in Figure 12-4. `SMCRremoteClient` has the main program. It holds a reference to `ClientCommandLine` and `MessageLogger`. `ClientCommandLine` knows how to parse the command line arguments. `MessageLogger` knows how to format and dispose of the various status messages that come from the different parts of the client program.

Figure 12-5 shows what happens when the client boots up. First it constructs an instance of the `SMCRremoteClient` and passes the command line arguments to it. The `SMCRremoteClient` constructor creates the `ClientCommandLine` object and directs it to parse the arguments. It then asks the `ClientCommandLine` to set the generic parameters like host, port, and verbose. The `ClientCommandLine` calls back to the `SMCRremoteClient` instance through the `ClientCommandLineProcessor` interface. Next the `SMCRremoteClient` creates the appropriate derivative of the `MessageLogger`, depending upon the state of the verbose flag. Finally, the `SMCRremoteClient` constructor returns, and `main` calls `run` upon the newly created `SMCRremoteClient` object.

The `run` method of `SMCRremoteClient` checks the validity of the command line. If the command line is malformed, it prints a usage message and exits. Otherwise it sends the `processCommand` message to the `ClientCommandLine` object. The `ClientCommandLine` responds by inspecting the command line arguments in order to determine whether they represent a registration or a compilation. Then, as shown in Figure 12-6 and Figure 12-7 the `ClientCommandLine` sends a message back to the `SMCRremoteClient` through

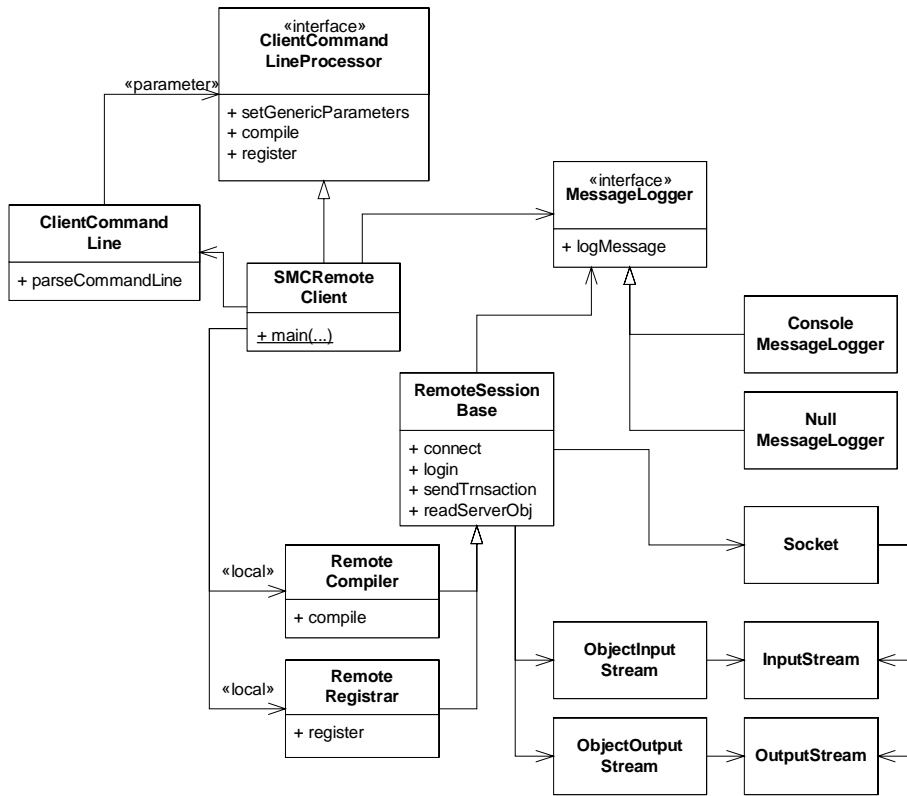

Figure 12-4
SMCRemoteClient Static Structure

the `ClientCommandLineProcessor` interface. The message it sends is either `register` or `compile`.

The code for `SMCRemoteClient`, `ClientCommandLine`, and `ClientCommandLineProcessor` is in Listing 12-1, Listing 12-2, and Listing 12-3 respectively. You should be able to match the interaction diagram in Figure 12-5 to the code in those listings.

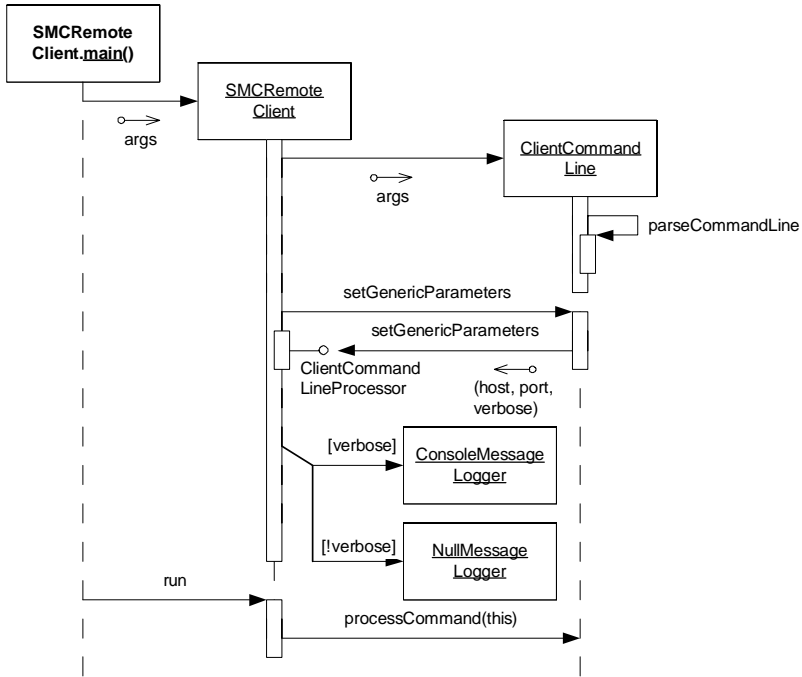

Figure 12-5
SMCRemoteClient.main()

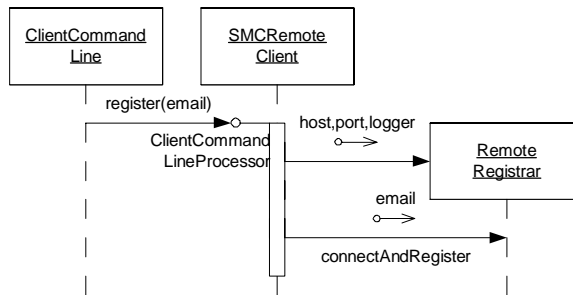

Figure 12-6
Registration

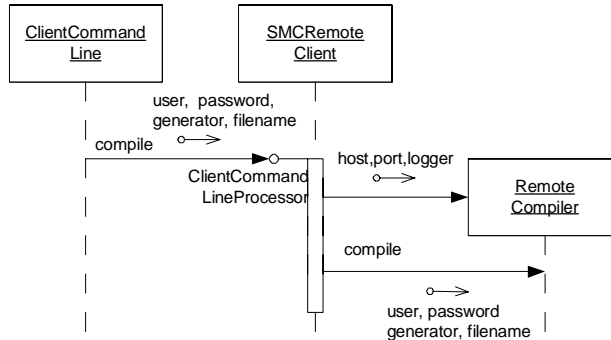

Figure 12-7
compilation

Listing 12-1
SMCRemoteClient.java

```

package com.objectmentor.SMCRemote.client;

public class SMCRemoteClient implements ClientCommandLineProcessor {
    public static final String VERSION = "$Id$";

    private ClientCommandLine commandLine;
    private String itsHost;
    private int itsPort;
    private boolean isVerbose = false;
    private MessageLogger itsLogger;

    public static void main(String[] args) {
        SMCRemoteClient client = new SMCRemoteClient(args);
        client.run();
    }

    public SMCRemoteClient(String[] args) {
        commandLine = new ClientCommandLine(args);
        commandLine.setGenericParameters(this);
        if (isVerbose)
            itsLogger = new ConsoleMessageLogger();
        else
            itsLogger = new NullMessageLogger();
    }

    private void run() {
        if (commandLine.isValid()) {
            logHeader();
            commandLine.processCommand(this);
        } else {
            System.out.println("usage: ");
            System.out.println(
                "  to compile: java SMCRemoteClient -u <emailaddress> -w <password> <filename>");
            System.out.println("  to register: java SMCRemoteClient -r <emailaddress>");
            System.out.println("options: -h <hostname>  override default hostname.");
        }
    }
}

```

Listing 12-1
SMCRemoteClient.java

```

        System.out.println("        -p <port>        override default port");
        System.out.println("        -v                verbose console output");
    }
}

public void setGenericParameters(String host, int port, boolean verbose) {
    itsHost = host;
    itsPort = port;
    isVerbose = verbose;
}

public void compile(String username, String password,
                    String generator, String filename) {
    RemoteCompiler compiler = new RemoteCompiler(itsHost, itsPort, itsLogger);
    compiler.compile(username, password, generator, filename);
}

public void register(String registrant) {
    RemoteRegistrar registrar = new RemoteRegistrar(itsHost, itsPort, itsLogger);
    registrar.connectAndRegister(registrant);
}

private void logHeader() {
    logMessage("SMCRemoteClient-----");
    logMessage(VERSION);
    logMessage("host =      " + itsHost);
    logMessage("port =      " + itsPort);
    logMessage("-----");
}

private void logMessage(String msg) {
    itsLogger.logMessage(msg);
}
}

```

Listing 12-2 (Continued)
ClientCommandLine.java

```

package com.objectmentor.SMCRemote.client;

import com.neoworks.util.Getopts;

public class ClientCommandLine {
    public static final String DEFAULT_HOST = "localhost";
    public static final String DEFAULT_PORT = "9000";
    public static final String DEFAULT_GENERATOR = "java";

    private String itsFilename = null;
    private String itsHost = DEFAULT_HOST;
    private int itsPort = Integer.parseInt(DEFAULT_PORT);
    private String itsGenerator = DEFAULT_GENERATOR;
    private boolean isVerbose = false;
    private String itsRegistrant;
    private String itsUsername;
    private String itsPassword;
    private boolean isValid = false;
}

```

Listing 12-2 (Continued)
ClientCommandLine.java

```
private Getopts opts;

public ClientCommandLine(String[] args) {
    isValid = parseCommandLine(args);
}

public boolean isValid() {
    return isValid;
}

public boolean parseCommandLine(String[] args) {
    opts = new Getopts("r:h:p:g:u:w:v", args);
    if (opts.error()) return false;

    try {
        itsFilename = opts.argv(0);
        itsHost = opts.option('h', DEFAULT_HOST);
        itsPort = Integer.parseInt(opts.option('p', DEFAULT_PORT));
        itsGenerator = opts.option('g', DEFAULT_GENERATOR);
        itsRegistrant = opts.option('r', null);
        itsUsername = opts.option('u', null);
        itsPassword = opts.option('w', null);
        isVerbose = opts.hasOption('v');
    } catch (NumberFormatException e) {
        return false;
    }

    return isCompileCommand() || isRegistrationCommand();
}

public void setGenericParameters(ClientCommandLineProcessor processor) {
    processor.setGenericParameters(itsHost, itsPort, isVerbose);
}

public void processCommand(ClientCommandLineProcessor processor) {
    if (isCompileCommand()) {
        processor.compile(itsUsername, itsPassword, itsGenerator, itsFilename);
    } else if (isRegistrationCommand()) {
        processor.register(itsRegistrant);
    }
}

private boolean hasFileName() {
    return opts argc() == 1;
}

private boolean isCompileCommand() {
    return opts.hasOption('u') &&
        opts.hasOption('w') &&
        !opts.hasOption('r') &&
        hasFileName();
}

private boolean isRegistrationCommand() {
    return opts.hasOption('r') &&
```

Listing 12-2 (Continued)
ClientCommandLine.java

```
(itsRegistrant != null) &&
!opts.hasOption('u') &&
!opts.hasOption('w') &&
!opts.hasOption('g') &&
!hasFileName();
}

public boolean isVerbose() {
    return isVerbose;
}

public String getHost() {
    return itsHost;
}

public String getFilename() {
    return itsFilename;
}

public int getPort() {
    return itsPort;
}

public String getGenerator() {
    return itsGenerator;
}

public String getUsername() {
    return itsUsername;
}

public String getPassword() {
    return itsPassword;
}
}
```

Listing 12-3
ClientCommandLineProcessor.java

```
package com.objectmentor.SMCRemote.client;

public interface ClientCommandLineProcessor {
    public void setGenericParameters(String host, int port, boolean verbose);
    public void compile(String username, String password, String generator, String filename);
    public void register(String registrant);
}
```

The Loggers

You can see the implementation of the logger files in Listing 12-4 through Listing 12-6. The `MessageLogger` interface allows the `SMCRemoteClient` and all its minions to log message. `NullMessageLogger` simply ignores those messages, whereas `ConsoleMessageLogger` prints the messages on standard out, along with time and date information.

Listing 12-4
MessageLogger.java

```
package com.objectmentor.SMCRemote.client;

public interface MessageLogger {
    public void logMessage(String msg);
}
```

Listing 12-5
NullMessageLogger.java

```
package com.objectmentor.SMCRemote.client;

public class NullMessageLogger implements MessageLogger {
    public void logMessage(String msg) {
    }
}
```

Listing 12-6
ConsoleMessageLogger.java

```
package com.objectmentor.SMCRemote.client;

import java.text.SimpleDateFormat;
import java.util.Date;

public class ConsoleMessageLogger implements MessageLogger {
    public void logMessage(String msg) {
        Date logTime = new Date();
        SimpleDateFormat fmt = new SimpleDateFormat("yyyy.MM.dd hh:mm:ss");
        String logTimeString = fmt.format(logTime);
        System.out.println(logTimeString + " | " + msg);
    }
}
```

The Remote Sessions.

Figure 12-8 shows more of the static structure of the RemoteRegistrar and RemoteCompiler. Both derive from the base class RemoteSessionBase which supplies them with some common utilities. These classes use the DATA TRANSFER OBJECT⁵ pattern in order to communicate with the server. The LoginTransaction, LoginResponseTransaction, RegistrationTransaction, RegistrationResponseTransaction, CompileFileTransaction, and CompilerResultsTransaction are the data transfer objects used by the remote sessions. These objects are data packets that are sent back and forth between the client and server. Indeed, you can see that these names are very similar to those used to name the messages in the protocol sequence diagrams in Figure 12-2 and Figure 12-3.

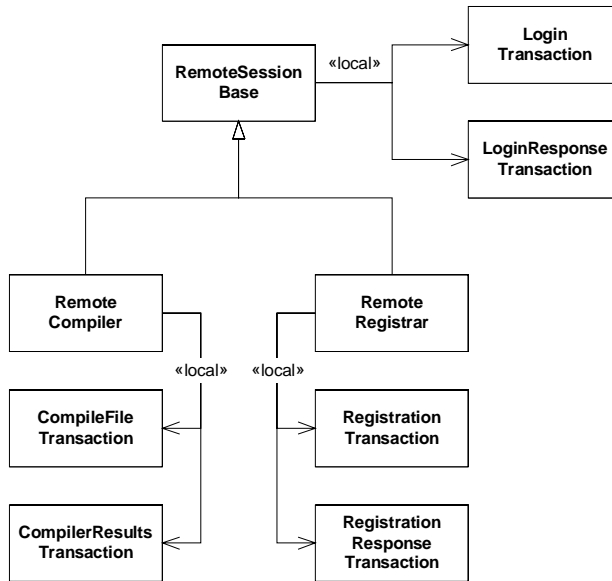

Figure 12-8
Remote Sessions.

5. [PEAA2002], page 401

RemoteSessionBase

The code for the `RemoteSessionBase`, and the two login transactions is shown in Listing 12-7, through Listing 12-9. `RemoteSessionBase` contains a set of utility functions that `RemoteRegistrar` and `RemoteCompiler` both use. It also contains the functions that perform the login protocol used by the `RemoteCompiler`.

Listing 12-7**RemoteSessionBase.java**

```
package com.objectmentor.SMCRemote.client;

import com.objectmentor.SMCRemote.transactions.*;

import java.io.*;
import java.net.Socket;

public class RemoteSessionBase {
    private String itsHost;
    private int itsPort;
    private MessageLogger itsLogger;
    private Socket smcrSocket;
    private ObjectInputStream is;
    private ObjectOutputStream os;

    public RemoteSessionBase(String itsHost, int itsPort, MessageLogger logger) {
        this.itsHost = itsHost;
        this.itsPort = itsPort;
        this.itsLogger = logger;
    }

    public String getHost() {
        return itsHost;
    }

    public int getPort() {
        return itsPort;
    }

    protected void logMessage(String msg) {
        itsLogger.logMessage(msg);
    }

    protected boolean connect() {
        logMessage("Trying to connect to: " + getHost() + ":" + getPort() + "...");
        boolean connectionStatus = false;
        try {
            smcrSocket = new Socket(getHost(), getPort());
            is = new ObjectInputStream(smcrSocket.getInputStream());
            os = new ObjectOutputStream(smcrSocket.getOutputStream());
            String headerLine = (String) readServerObject();
            connectionStatus = headerLine != null && headerLine.startsWith("SMCR");
            String message = (String) readServerObject();
            if (message != null) {
                System.out.println(message);
            }
        }
    }
}
```

Listing 12-7
RemoteSessionBase.java

```

        if (connectionStatus)
            logMessage("Connection acknowledged: " + headerLine);
        else
            logMessage("Bad Acknowledgement: " + headerLine);
    } catch (Exception e) {
        connectionStatus = false;
        logMessage("Connection failed: " + e.getMessage());
    }
    return connectionStatus;
}

public void close() {
    if (is != null || os != null || smcrSocket != null) {
        logMessage("Closing Connection.");
        try {
            if (is != null) is.close();
            if (os != null) os.close();
            if (smcrSocket != null) smcrSocket.close();
        } catch (IOException e) {
            logMessage("Couldn't close : " + e.getMessage());
        }
    }
}

protected boolean login(String username, String password) {
    try {
        LoginTransaction lt = new LoginTransaction(username, password);
        sendTransaction(lt);
        LoginResponseTransaction lrt = (LoginResponseTransaction) readServerObject();
        if (lrt.isAccepted()) {
            logMessage("login (" + lrt.getLoginCount() + ") accepted.");
            return true;
        } else {
            logMessage("Login Rejected");
            return false;
        }
    } catch (Exception e) {
        logMessage("login failed: " + e);
        return false;
    }
}

protected boolean sendTransaction(SocketTransaction t) {
    boolean sent = false;
    try {
        os.writeObject(t);
        os.flush();
        sent = true;
    } catch (IOException e) {
        sent = false;
    }
    return sent;
}

```

Listing 12-7
RemoteSessionBase.java

```
protected Object readServerObject() throws Exception {
    return is.readObject();
}
```

Listing 12-8
LoginTransaction.java

```
package com.objectmentor.SMCRemote.transactions;

public class LoginTransaction implements SocketTransaction {
    private String itsUserName;
    private String itsPassword;

    public LoginTransaction(String itsUserName, String itsPassword) {
        this.itsUserName = itsUserName;
        this.itsPassword = itsPassword;
    }

    public String getUser_name() {
        return itsUserName;
    }

    public String getPassword() {
        return itsPassword;
    }

    public void accept(SocketTransactionProcessor processor) throws Exception {
        processor.process(this);
    }
}
```

Listing 12-9
LoginResponseTransaction.java

```
package com.objectmentor.SMCRemote.transactions;

public class LoginResponseTransaction implements SocketTransaction {
    private boolean isAccepted;
    private int loginCount;

    public LoginResponseTransaction(boolean accepted, int loginCount) {
        this.loginCount = loginCount;
        this.isAccepted = accepted;
    }

    public boolean isAccepted() {
        return isAccepted;
    }

    public int getLoginCount() {
        return loginCount;
    }

    public void accept(SocketTransactionProcessor processor) throws Exception {
        processor.process(this);
    }
}
```

Listing 12-9
LoginResponseTransaction.java

```
}  
}
```

The first three lines of the `RemoteSessionBase.login()` function are particularly illustrative.

```
LoginTransaction lt = new LoginTransaction(username, password);  
sendTransaction(lt);  
LoginResponseTransaction lrt = (LoginResponseTransaction) readServerObject();
```

These lines show how all the communication across the sockets is achieved. As you can see from Listing 12-10, all the transactions are serializable, so it is absurdly simple to write them to, and read them from, a socket.

Listing 12-10
SocketTransaction.java

```
package com.objectmentor.SMCRemote.transactions;  
  
import java.io.Serializable;  
  
public interface SocketTransaction extends Serializable {  
    public void accept(SocketTransactionProcessor processor) throws Exception;  
}
```

Listing 12-10 shows one other thing. There is the hint of a VISITOR⁶ pattern lurking in the `SocketTransaction` class. We won't see why until we study the `SMCRemoteServer` later on in this chapter.

The Remote Registrar

The `RemoteRegistrar`, and the two registration transactions are shown in Listing 12-11 through Listing 12-13. The process is very simple. It simply connects to the server and sends the `RegistrationTransaction`. Then it receives the `RegistrationResponseTransaction` and makes sure that it was accepted by the server.

Listing 12-11
RemoteRegistrar.java

```
package com.objectmentor.SMCRemote.client;  
  
import com.objectmentor.SMCRemote.transactions.*;  
  
public class RemoteRegistrar extends RemoteSessionBase {  
  
    public RemoteRegistrar(String itsHost, int itsPort, MessageLogger logger) {  
        super(itsHost, itsPort, logger);  
    }  
  
    public void connectAndRegister(String registrant) {
```

6. [GOF95], p 331

Listing 12-11 (Continued)
RemoteRegistrar.java

```

    if (connect()) {
        RegistrationResponseTransaction rrt;
        if ((rrt = register(registrant)) != null) {
            if (rrt.isConfirmed()) {
                logMessage(registrant + " was registered");
                System.out.println("User: " + registrant + " registered. Email sent.");
            } else {
                logMessage(registrant + " was NOT registered: " + rrt.getFailureReason());
                System.out.println(
                    registrant + " was NOT registered: " + rrt.getFailureReason());
            }
        } else { // rrt == null
            System.out.println("Something bad happened. Sorry.");
        }
        close();
    } else { // connect
        System.out.println("failed to connect to " + getHost() + ":" + getPort());
    }
}

RegistrationResponseTransaction register(String registrant) {
    logMessage("Attempting to register " + registrant);
    RegistrationTransaction t = new RegistrationTransaction(registrant);
    sendTransaction(t);
    RegistrationResponseTransaction rrt = null;
    try {
        rrt = (RegistrationResponseTransaction) readServerObject();
    } catch (Exception e) {
        logMessage("Could not send registration response: " + e.getMessage());
        return null;
    }
    return rrt;
}
}

```

Listing 12-12
RegistrationTransaction.java

```

package com.objectmentor.SMCRemote.transactions;

public class RegistrationTransaction implements SocketTransaction {
    private String username;

    public String getUsername() {
        return username;
    }

    public RegistrationTransaction(String username) {
        this.username = username;
    }

    public void accept(SocketTransactionProcessor processor) throws Exception {
        processor.process(this);
    }
}

```

Listing 12-13
RegistrationResponseTransaction.java

```

package com.objectmentor.SMCRemote.transactions;

public class RegistrationResponseTransaction implements SocketTransaction {
    private boolean confirmed;
    private String failureReason;

    public RegistrationResponseTransaction(boolean confirmed) {
        this.confirmed = confirmed;
    }

    public String getFailureReason() {
        return failureReason;
    }

    public void setFailureReason(String failureReason) {
        this.failureReason = failureReason;
    }

    public boolean isConfirmed() {
        return confirmed;
    }

    public void accept(SocketTransactionProcessor processor) throws Exception {
        processor.process(this);
    }
}

```

The Remote Compiler

The `RemoteCompiler` (Listing 12-14) is a bit more complicated than the `RemoteRegistrar`; though the idea is the same. Figure 12-9 is a rough model of the sequence. The diagram does not completely conform to the code, but it's pretty close. Making it conform to completely to the code would have made the diagram more cluttered than it should have been. By the same token, making the code correspond to the diagram would have made the code more cluttered than it should have been. This kind of mismatch between the code and diagram is not uncommon. The clarity of each is satisfied in different ways.

In the code, compilation begins when the `ClientCommandLine` instance calls the `compile()` method of `SMCRemoteCompiler`; which in turn creates the `RemoteCompiler` and calls its `compile()` method.

The `compile()` method of `RemoteCompiler` logs a header message and then calls `connectAndRequestCompile()`. This method makes sure that the file to be compiled exists, connects to the server, and then invoke the `login()` method. The `login()` method executes the login protocol. If the login succeeds, the `compileFile()` method is invoked. This method builds the `CompileFileTransaction` (Listing 12-15) object and sends it to the server. It then reads the `CompilerResultsTransaction` (Listing 12-16) from the server and writes any files it contains onto the local filesystem.

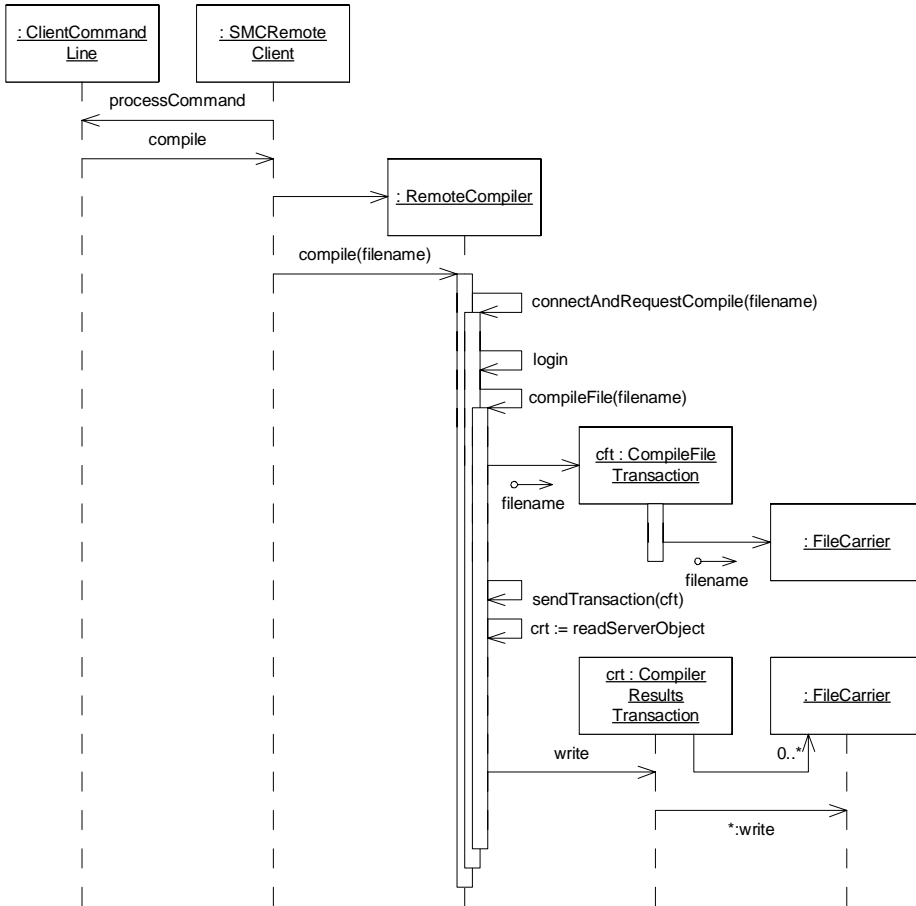

Figure 12-9
Compile Process

Listing 12-14
RemoteCompiler.java

```

package com.objectmentor.SMCRemote.client;

import com.objectmentor.SMCRemote.transactions.*;

import java.io.*;
import java.util.Vector;

public class RemoteCompiler extends RemoteSessionBase {

    private String itsFilename = null;
    private String itsGenerator = ClientCommandLine.DEFAULT_GENERATOR;
    
```

Listing 12-14 (Continued)**RemoteCompiler.java**

```

private String itsRegistrant;

public RemoteCompiler(String itsHost, int itsPort, MessageLogger itsLogger) {
    super(itsHost, itsPort, itsLogger);
}

public void compile(String username, String password,
    String generator, String filename) {
    itsFilename = filename;
    itsGenerator = generator;
    logCompileHeader();
    connectAndRequestCompile(username, password);
}

private void connectAndRequestCompile(String username, String password) {
    if (prepareFile()) {
        if (connect()) {
            if (login(username, password)) {
                if (compile() == false) {
                    System.out.println("Internal error, something awful. Sorry.");
                }
            } else { // login
                System.out.println("failed to log in.");
            }
            close();
        } else { // connect
            System.out.println("failed to connect to " + getHost() + ":" + getPort());
        }
    } else { // prepareFile
        System.out.println("could not open: " + itsFilename);
    } // prepareFile
}

private boolean compile() {
    CompilerResultsTransaction crt = compileFile();
    if (crt == null)
        return false;
    writeCompilerOutputLines(crt);
    return true;
}

public void setFilename(String itsFilename) {
    this.itsFilename = itsFilename;
}

public boolean prepareFile() {
    File f = new File(itsFilename);
    return f.exists();
}

public CompilerResultsTransaction compileFile() {
    CompilerResultsTransaction crt = null;
    logMessage("Sending file and requesting compilation.");
    try {
        CompileFileTransaction t = new CompileFileTransaction(itsFilename, itsGenerator);
        if (sendTransaction(t) == true) {

```

Listing 12-14 (Continued)
RemoteCompiler.java

```

        crt = (CompilerResultsTransaction) readServerObject();
        logCompilerResultsMessage(crt);
        crt.write();
    }
} catch (Exception e) {
    logMessage("Compilation process failed: " + e.getMessage());
}

return crt;
}

private static void writeCompilerOutputLines(CompilerResultsTransaction crt) {
    Vector stdout = crt.getStdoutLines();
    writeLineVector(System.out, crt.getStdoutLines());
    writeLineVector(System.err, crt.getStderrLines());
}

private static void writeLineVector(PrintStream ps, Vector stdout) {
    for (int i = 0; i < stdout.size(); i++) {
        String s = (String) stdout.elementAt(i);
        ps.println(s);
    }
}

private void logCompileHeader() {
    logMessage("Compiling...");
    logMessage("file = " + itsFilename);
    logMessage("generator = " + itsGenerator);
}

private void logCompilerResultsMessage(CompilerResultsTransaction crt) {
    logMessage("Compilation results received.");
    String filenames[] = crt.getFileNames();
    for (int i = 0; i < filenames.length; i++) {
        String s = (String) filenames[i];
        logMessage("..file: " + s + " received.");
    }
}
}
}

```

Listing 12-15
CompileFileTransaction.java

```

package com.objectmentor.SMCRemote.transactions;

import com.objectmentor.SocketUtilities.FileCarrier;

import java.io.File;

public class CompileFileTransaction implements SocketTransaction {
    private FileCarrier itsCarrier;
    private String itsGenerator;

    public CompileFileTransaction(String filename, String generator) {
        itsCarrier = new FileCarrier(null, filename);
        itsGenerator = generator;
    }
}

```

Listing 12-15 (Continued)
CompileFileTransaction.java

```
}

public String getFilename() {
    return itsCarrier.getFilename();
}

public String getGenerator() {
    return itsGenerator;
}

public void write(File subDirectory) {
    itsCarrier.write(subDirectory);
}

public void accept(SocketTransactionProcessor processor) throws Exception {
    processor.process(this);
}
}
```

Listing 12-16
CompilerResultsTransaction.java

```
package com.objectmentor.SMCRemote.transactions;

import com.objectmentor.SocketUtilities.FileCarrier;

import java.io.File;
import java.util.Vector;

public class CompilerResultsTransaction implements SocketTransaction {
    public static final int OK = 0;
    public static final int NOT_LOGGED_IN = 1;

    private FileCarrier[] files;
    private String[] filenames;
    private Vector stdout;
    private Vector stderr;
    private int status;

    public int getStatus() {
        return status;
    }

    public void setStatus(int status) {
        this.status = status;
    }

    public Vector getStdoutLines() {
        return stdout;
    }

    public Vector getStderrLines() {
        return stderr;
    }

    public String[] getFilenames() {
```

Listing 12-16 (Continued)
CompilerResultsTransaction.java

```

    return filenames;
}

public CompilerResultsTransaction() {
    stdout = new Vector();
    stderr = new Vector();
}

public void loadFiles(File subDirectory, String[] filenames) {
    this.filenames = filenames;
    files = new FileCarrier[filenames.length];
    for (int fileIndex = 0; fileIndex < filenames.length; fileIndex++) {
        files[fileIndex] = new FileCarrier(subDirectory, filenames[fileIndex]);
    }
}

public void write() {
    for (int fileIndex = 0; fileIndex < files.length; fileIndex++) {
        FileCarrier carrier = files[fileIndex];
        carrier.write();
    }
}

public void accept(SocketTransactionProcessor processor) throws Exception {
    processor.process(this);
}
}

```

FileCarrier

Both the `CompileFileTransaction` and the `CompilerResultsTransaction` need to carry text files across the client/server boundary. They do this by using a helper class called `FileCarrier`. `FileCarrier` holds the name of the file being carried, and a list of strings which correspond to the lines of text in the file. It contains methods for loading the `FileCarrier` from a file, and for creating a new file from the `FileCarrier`.

Listing 12-17
FileCarrier.java

```

package com.objectmentor.SocketUtilities;

import java.io.*;
import java.util.*;

public class FileCarrier implements Serializable {
    private String itsFilename;
    private LinkedList itsLines = new LinkedList();
    private boolean loaded = false;
    private boolean error = false;

    public FileCarrier(File subDirectory, String filename) {
        File inputFile = new File(subDirectory, filename);
        itsFilename = new String(filename);
    }
}

```

Listing 12-17
FileCarrier.java

```

BufferedReader br = null;
try {
    br = new BufferedReader(new InputStreamReader(new FileInputStream(inputFile)));
    String line;
    while ((line = br.readLine()) != null) {
        itsLines.add(line);
    }
    br.close();
    loaded = true;
} catch (Exception e) {
    error = true;
}
}

public void write() {
    write(null);
}

public void write(File subDirectory) {
    File f = new File(subDirectory, itsFilename);
    if (f.exists()) f.delete();
    try {
        PrintStream w = new PrintStream(new FileOutputStream(f));
        for (Iterator i = itsLines.iterator(); i.hasNext();) {
            String line = (String) i.next();
            w.println(line);
        }
        w.close();
    } catch (IOException e) {
        error = true;
    }
}

public boolean isLoaded() {
    return loaded;
}

public boolean isError() {
    return error;
}

public String getFilename() {
    return itsFilename;
}
}

```

SMCRemoteClient Conclusion

That's pretty much all there is to say about the `SMCRemoteClient`. It's a pretty simple process. It reads its command line arguments, figures out whether to perform a registration or a compilation, builds the appropriate transactions and sends them to the server, and reads the response transactions back. Not rocket science.

SMCRemoteServer

The server is a bit more complex than the client. It must run continuously, accepting connections and responding to them. It must also be able to deal with many concurrent transactions. It must maintain a database of registrations, and must know how to invoke, control and capture the output of the SMC compiler.

The story of the server begins with a bit of framework that I, and my son Micah, put together some months back.

SocketService

While we were working on a Ruby web server named ROPE, Micah and I wrote a simple Ruby framework to accept incoming socket requests. It worked very nicely and was so generic that I later translated it into a simple Java framework for socket servers⁷. This framework creates the server socket, waits for connections on that socket, and spawns a new thread for each incoming connection. Figure 12-1 shows its structure.

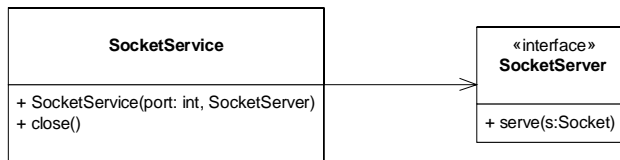

Figure 12-10
SocketService

The idea is pretty simple. If you want to write a program that serves incoming socket connections, you derive your program from `SocketServer`. Then you create an instance of the `SocketService` and pass your derivative into the constructor, along with the number of the port that you want your server to listen at. From then on, whenever a connection comes into that port, a new thread will be created and the `serve` method of your derivative will be invoked in that new thread.

For example, `HelloService` in Listing 12-18 is a simple socket service that responds to an incoming connection by sending “Hello” and then closing the connection. The program in Listing 12-19 tests that `HelloService` does what it is supposed to.

Listing 12-18
Socket service that says “Hello”.

```
class HelloService implements SocketServer {
    public void serve(Socket s) {
```

7. Yes, this is the same framework that I’ve been using for fodder in my “Craftsman” column in Software Development Magazine.

Listing 12-18
Socket service that says "Hello".

```
try {
    OutputStream os = s.getOutputStream();
    PrintStream ps = new PrintStream(os);
    ps.println("Hello");
} catch (IOException e) {
}
}
```

Listing 12-19
A client that tests the HelloService.

```
public void testSendMessage() throws Exception {
    ss = new SocketService(999, new HelloService());
    Socket s = new Socket("localhost", 999);
    BufferedReader br = TestUtility.GetBufferedReader(s);
    String answer = br.readLine();
    s.close();
    ss.close();
    assertEquals("Hello", answer);
}
```

The complete implementation of the `SocketService` framework is shown in Listing 12-20 through Listing 12-21. The jist of its operation is shown below in Figure 12-11. The `SocketService` begins it's life by spawning the `serviceThread` and then returning. The `serviceThread` hangs in a loop calling `accept` on the `serverSocket`. The call to `accept` returns with a new socket each time there is an incoming connection. The `serviceThread` then spawns a new `serverThread` and loops back to call `accept` on the `ServerSocket` again. The `serverThread` calls `serve` on the `SocketServer` derivative supplied by the user.

As an aside, the diagram in Figure 12-11 shows how rapidly message sequence numbers can become unworkable in UML collaboration diagrams. This particular sequence of messages is much better shown as a collaboration diagram than as a sequence diagram, since exposing the topology of the relationships is more important than exposing the sequence of events. Unfortunately, even mildly complex scenarios lead to sequence numbers that look more like organic chemistry than software.

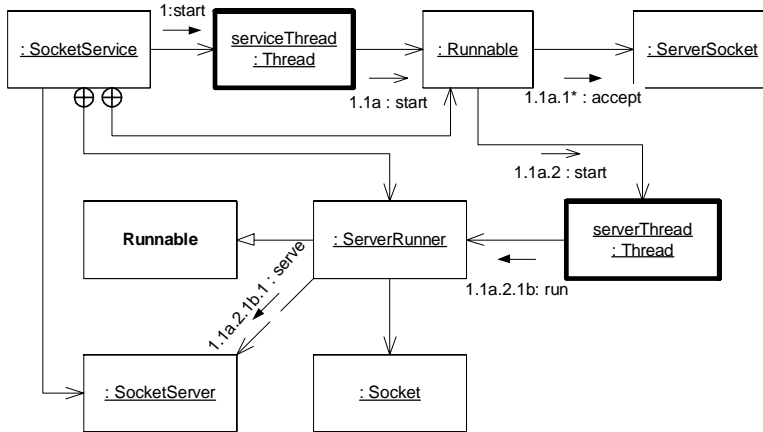

Figure 12-11
SocketService Object Diagram

Listing 12-20
SocketServer.java

```
package com.objectmentor.SocketService;

import java.net.Socket;

public interface SocketServer
{
    public void serve(Socket s);
}
```

Listing 12-21
SocketService.java

```
package com.objectmentor.SocketService;

import java.io.IOException;
import java.net.*;
import java.util.LinkedList;

public class SocketService {
    private ServerSocket serverSocket = null;
    private Thread serviceThread = null;
    private boolean running = false;
    private SocketServer itsService = null;
    private LinkedList threads = new LinkedList();

    public SocketService(int port, SocketServer service)
    throws Exception {
        itsService = service;
        serverSocket = new ServerSocket(port);
        serviceThread = new Thread(
            new Runnable() {
```

Listing 12-21 (Continued)
SocketService.java

```
        public void run() {
            serviceThread();
        }
    };
    serviceThread.start();
}

public void close() throws Exception {
    waitForServiceThreadToStart();
    running = false;
    serverSocket.close();
    serviceThread.join();
    waitForServerThreads();
}

private void waitForServiceThreadToStart() {
    while (running == false) Thread.yield();
}

private void serviceThread() {
    running = true;
    while (running) {
        try {
            Socket s = serverSocket.accept();
            startServerThread(s);
        } catch (IOException e) {
        }
    }
}

private void startServerThread(Socket s) {
    Thread serverThread = new Thread(new ServerRunner(s));
    synchronized (threads) {
        threads.add(serverThread);
    }
    serverThread.start();
}

private void waitForServerThreads()
throws InterruptedException {
    while (threads.size() > 0) {
        Thread t;
        synchronized (threads) {
            t = (Thread) threads.getFirst();
        }
        t.join();
    }
}

private class ServerRunner implements Runnable {
    private Socket itsSocket;

    ServerRunner(Socket s) {
        itsSocket = s;
    }
}
```

Listing 12-21 (Continued)
SocketService.java

```
    }  
  
    public void run() {  
        try {  
            itsService.serve(itsSocket);  
            synchronized (threads) {  
                threads.remove(Thread.currentThread());  
            }  
            itsSocket.close();  
        } catch (IOException e) {  
        }  
    }  
}
```

SMCRemoteService

Clearly we can build upon the `SocketService` framework to create the `SMCRemoteService` program. The diagram in Figure 12-12 shows the structure. `SMCRemoteService` has a `SocketService` instance which it initializes with an anonymous inner class that implements the `SocketServer` interface. This class delegates to `SMCRemoteServer` which handles the protocols for each connection.

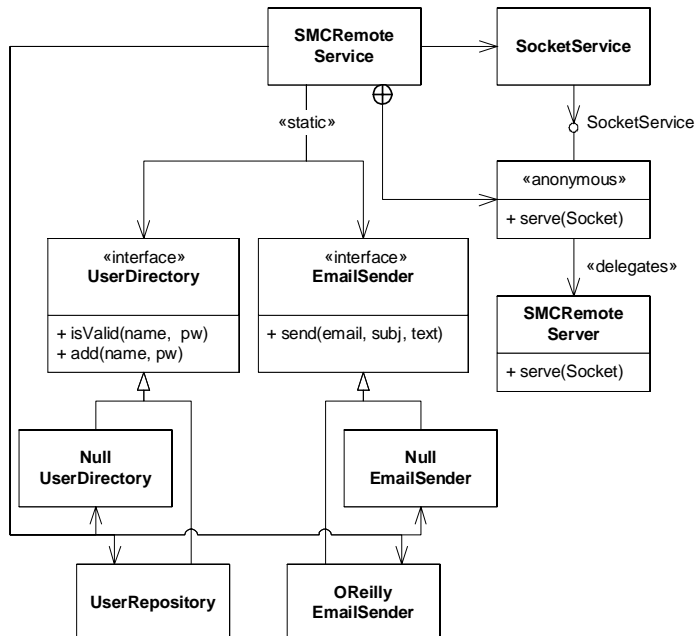

Figure 12-12
High level structure of `SMCRemoteService`

`SMCRemoteService` also holds a reference to a `UserDirectory` and an `EmailSender`. These two classes have two derivatives each; one is a `NULLOBJECT`⁸ and the other provides a functional implementation. The functional implementation of `UserDirectory` is named `UserRepository`. This class manages the user database. It allows users to be added to the database. It also provides methods for checking the password of a user. The functional implementation of `EmailSender` is `OReillyEmailSender`. This class makes use of a third party SMTP agent to send email.

8. See the `NullObject` pattern in [PPP2002], p 189

The listings for `SMCRemoteService` and the two interfaces are in Listing 12-22 through Listing 12-24. For the most part `SMCRemoteService` contains a set of utilities that `SMCRemoteServer` uses.

Listing 12-22
SMCRemoteService.java

```
package com.objectmentor.SMCRemote.server;

import com.objectmentor.SocketService.*;

import com.neoworks.util.Getopts;

import java.io.*;
import java.text.SimpleDateFormat;
import java.util.*;
import java.net.Socket;

class NullUserDirectory implements UserDirectory {
    public boolean isValid(String username, String password) {
        return true;
    }

    public String getPassword(String username) {
        return null;
    }

    public int incrementLoginCount(String username) {
        return 0;
    }

    public boolean add(String username, String password) {
        return true;
    }
}

class NullEmailSender implements EmailSender {
    public boolean send(String emailAddress, String subject, String text) {
        return true;
    }
}

public class SMCRemoteService {
    public static final String DEFAULT_PORT = "9000";
    public static final String VERSION = "0.99";
    public static final String COMPILE_COMMAND = "java -cp c:\\SMC\\smc.jar smc.Smc -f";

    static boolean isVerbose = false;
    static boolean isEmailQuiet = false;
    static int servicePort;
    static String messageFile;

    private static UserDirectory userDirectory = new NullUserDirectory();
    private static EmailSender emailSender = new NullEmailSender();
    private SocketService service;

    SocketServer server = new SocketServer() {
```

Listing 12-22 (Continued)
SMCRemoteService.java

```

public void serve(Socket socket) {
    new SMCRemoteServer().serve(socket);
}
};

public SMCRemoteService(int port) throws Exception {
    service = new SocketService(port, server);
}

public void close() throws Exception {
    service.close();
}

static void setUserDirectory(UserDirectory userDirectory) {
    SMCRemoteService.userDirectory = userDirectory;
}

public static void setEmailSender(EmailSender emailSender) {
    SMCRemoteService.emailSender = emailSender;
}

public static void main(String[] args) {
    if (parseCommandLine(args)) {
        verboseHeader();
        setUserDirectory(new UserRepository("users"));
        if (!isEmailQuiet) setEmailSender(new OReillyEmailSender());
        try {
            SMCRemoteService service = new SMCRemoteService(servicePort);
        } catch (Exception e) {
            System.err.println("Could not connect");
        }
    } else {
        System.out.println("usage: java SMCRemoteService -p <port> -v");
    }
}

static boolean validate(String username, String password) {
    return userDirectory.isValid(username, password);
}

static boolean addUser(String username, String password) throws Exception {
    return userDirectory.add(username, password);
}

static String getPassword(String username) {
    return userDirectory.getPassword(username);
}

static int incrementLoginCount(String username) throws Exception {
    return userDirectory.incrementLoginCount(username);
}

static boolean sendEmail(String emailAddress, String subject, String text) {
    return emailSender.send(emailAddress, subject, text);
}

```

Listing 12-22 (Continued)
SMCRemoteService.java

```
static boolean parseCommandLine(String[] args) {
    Getopts opts = new Getopts("m:p:ve", args);
    if (opts.error())
        return false;

    try {
        servicePort = Integer.parseInt(opts.option('p', DEFAULT_PORT));
        isVerbose = opts.hasOption('v');
        messageFile = opts.option('m', null);
        isEmailQuiet = opts.hasOption('e');
    } catch (NumberFormatException e) {
        return false;
    }

    return true;
}

static String buildCommand(String filename, String generator) {
    String generatorClass;

    if (generator.equals("java"))
        generatorClass = "smc.generator.java.SMJavaGenerator";
    else if (generator.equals("C++"))
        generatorClass = "smc.generator.cpp.SMCppGenerator";
    else
        return "echo bad generator " + generator;

    return COMPILER_COMMAND + " -g " + generatorClass + " " + filename;
}

static int executeCommand(String command, Vector stdout, Vector stderr)
throws Exception {
    Runtime rt = Runtime.getRuntime();
    Process p = rt.exec(command);
    flushProcessOutputs(p, stdout, stderr);
    p.waitFor();

    return p.exitValue();
}

private static void flushProcessOutputs(Process p, Vector stdout, Vector stderr)
throws IOException {
    BufferedReader stdoutReader =
        new BufferedReader(new InputStreamReader(p.getInputStream()));
    BufferedReader stderrReader =
        new BufferedReader(new InputStreamReader(p.getErrorStream()));
    String line;

    while ((line = stdoutReader.readLine()) != null)
        stdout.add(line);
    while ((line = stderrReader.readLine()) != null)
        stderr.add(line);
}
```

Listing 12-22 (Continued)
SMCRemoteService.java

```

static File makeTempDirectory() {
    File tmpDirectory;
    do {
        long millis = System.currentTimeMillis();
        tmpDirectory = new File("smcTempDirectory" + millis);
    } while (!tmpDirectory.exists());
    tmpDirectory.mkdir();
    return tmpDirectory;
}

private static void verboseHeader() {
    verboseMessage("SMCRemoteService-----");
    verboseMessage(VERSION);
    verboseMessage("port = " + servicePort);
    if (isEmailQuiet) verboseMessage("email is disabled");
    verboseMessage("-----");
}

static void verboseMessage(String msg) {
    if (isVerbose) {
        Date logTime = new Date();
        SimpleDateFormat fmt = new SimpleDateFormat("yyyy.MM.dd hh:mm:ss");
        String logTimeString = fmt.format(logTime);

        System.out.println(logTimeString + " | " + msg);
    }
}
}

```

Listing 12-23
UserDirectory.java

```

package com.objectmentor.SMCRemote.server;

public interface UserDirectory {
    public boolean isValid(String username, String password);
    public boolean add(String username, String password) throws Exception;
    public String getPassword(String username);
    public int incrementLoginCount(String username) throws Exception;
}

```

Listing 12-24
EmailSender.java

```

package com.objectmentor.SMCRemote.server;

public interface EmailSender {
    public boolean send(String emailAddress, String subject, String text);
}

```

SMCRemoteServer

SMCRemoteServer is a simple class. It hangs in a loop reading SocketTransaction objects from the socket. It uses the VISITOR⁹ pattern to decode the transactions it reads.

Once the transaction is decoded, SMCRemoteServer sends the appropriate event to the ServerSession instance. See Figure 12-13 and Figure 12-14.

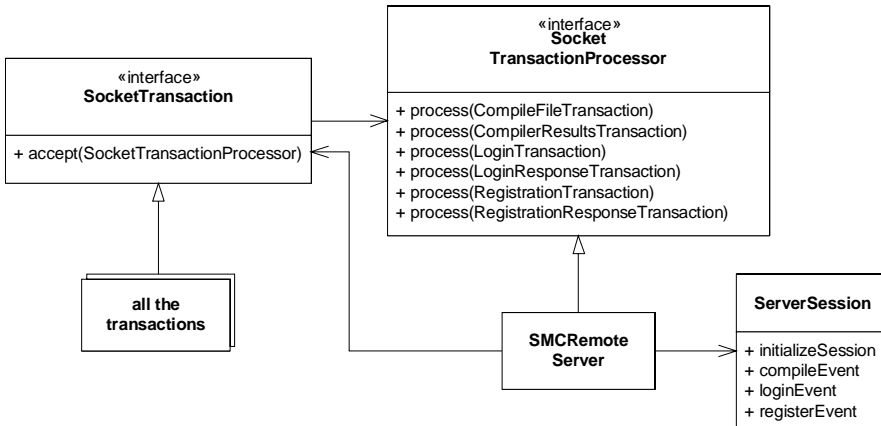

Figure 12-13
SMCRemoteServer structure. The Transaction Visitor Pattern.

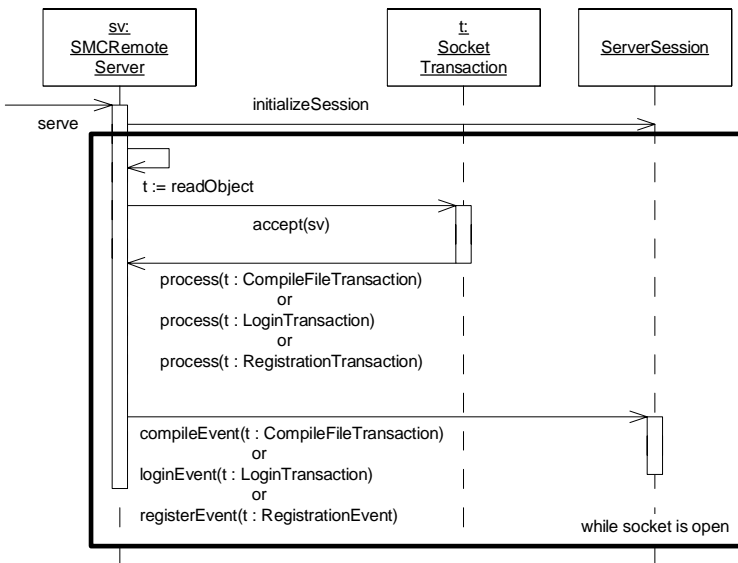

Figure 12-14
SMCRemoteServer Transaction Decoding

9. The Visitor pattern is described in [GOF95], p331, and there are significant examples in [PPP2002] p. 388

Each time the `SMCRemoteServer` reads a `SocketTransaction` from the socket, it passes itself to the `accept` function of that transaction. This works because `SMCRemoteServer` implements the `SocketTransactionProcessor` interface. The transaction calls back through this interface to the appropriate `process` function. That function, in turn, sends the appropriate event to the `ServerSession` object. Listing 12-25 and Listing 12-26 show the `SMCRemoteServer` and `SocketTransactionProcessor` classes.

Listing 12-25
SMCRemoteServer.java

```
package com.objectmentor.SMCRemote.server;

import com.objectmentor.SMCRemote.transactions.*;
import com.objectmentor.SocketService.SocketServer;

import java.io.ObjectInputStream;
import java.net.Socket;

class SMCRemoteServer extends SocketTransactionProcessor {
    private ObjectInputStream serverInput;
    private boolean isOpen = false;
    private ServerSession session;

    public void serve(Socket socket) {
        isOpen = true;

        try {
            session = new ServerSession(this, socket);
            session.verboseMessage("Connected");
            serverInput = session.initializeSession(socket);
            while (isOpen) {
                SocketTransaction st = (SocketTransaction) serverInput.readObject();
                st.accept(this);
            }
        } catch (Exception e) {
            SMCRemoteService.verboseMessage("Connection torn down:" + e);
            return;
        }
        SMCRemoteService.verboseMessage("Connection closed normally.");
    }

    public void process(CompileFileTransaction t) throws Exception {
        session.compileEvent(t);
    }

    public void process(LoginTransaction t) throws Exception {
        session.loginEvent(t);
    }

    public void process(RegistrationTransaction t) throws Exception {
        session.registerEvent(t);
    }

    public void close() {
        isOpen = false;
    }
}
```

Listing 12-25 (Continued)
SMCRemoteServer.java

```
}  
}
```

Listing 12-26
SocketTransactionProcessor.java

```
package com.objectmentor.SMCRemote.transactions;  
  
public class SocketTransactionProcessor {  
    public void process(CompileFileTransaction t) throws Exception {  
        throw new NoProcessorException("CompileFileTransaction");  
    }  
  
    public void process(CompilerResultsTransaction t) throws Exception {  
        throw new NoProcessorException("CompilerResultsTransaction");  
    }  
  
    public void process(LoginTransaction t) throws Exception {  
        throw new NoProcessorException("LoginTransaction");  
    }  
  
    public void process(LoginResponseTransaction t) throws Exception {  
        throw new NoProcessorException("LoginResponseTransaction");  
    }  
  
    public void process(RegistrationTransaction t) throws Exception {  
        throw new NoProcessorException("RegistrationTransaction");  
    }  
  
    public void process(RegistrationResponseTransaction t) throws Exception {  
        throw new NoProcessorException("RegistrationResponseTransaction");  
    }  
}
```

ServerSession

The `ServerSession` class is a finite state machine that controls the communication protocols between the client and the server. The state transition diagram that shows this logic is in Figure 12-15. Note that registrations can take place right from the `Idle` state, but in order to do a compile you must login first.

This finite state machine was translated into SMC code, and compiled into Java. The SMC input is shown in Listing 12-27. If you are interested the generated output is shown at the end of the chapter in Listing 12-46.

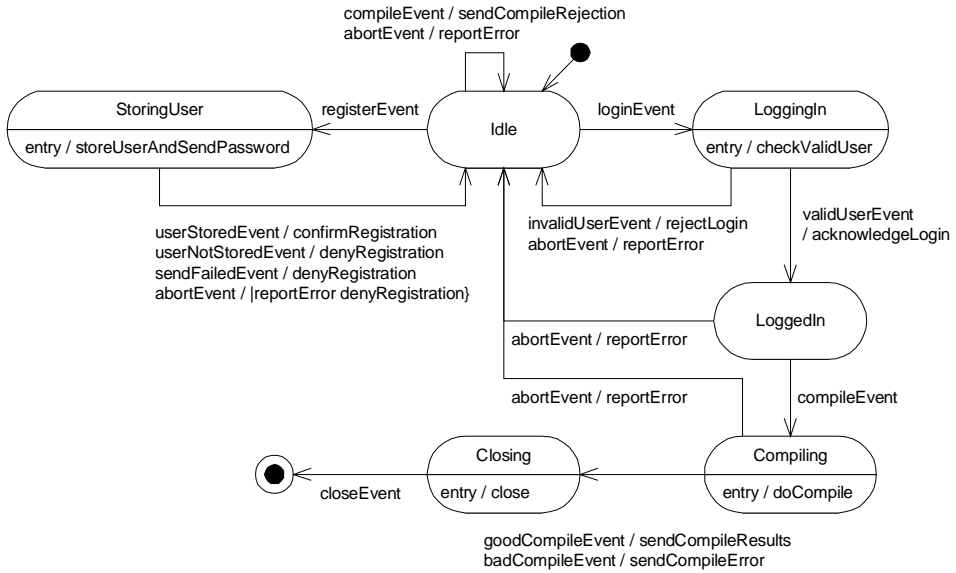

Figure 12-15
ServerSession Finite State Machine.

Listing 12-27
server.sm

```

Context ServerControllerContext
FSMName ServerController
Pragma Package com.objectmentor.SMCRemote.server
Initial Idle
{
  Idle {
    loginEvent      LoggingIn  {}
    compileEvent    Idle       sendCompileRejection
    registerEvent   StoringUser {}
    abortEvent      *          reportError
  }

  StoringUser <storeUserAndSendPassword {
    userStoredEvent  Idle      confirmRegistration
    userNotStoredEvent Idle    denyRegistration
    sendFailedEvent  Idle      denyRegistration
    abortEvent       Idle      {reportError denyRegistration}
  }

  LoggingIn <checkValidUser {
    validUserEvent  LoggedIn   acknowledgeLogin
    invalidUserEvent Idle      rejectLogin
    abortEvent      Idle       reportError
  }
}
    
```

Listing 12-27 (Continued)
server.sm

```

LoggedIn {
  compileEvent    Compiling {}
  abortEvent     Idle      reportError
}

Compiling <doCompile {
  goodCompileEvent Closing  sendCompileResults
  badCompileEvent  Closing  sendCompileError
  abortEvent       Idle      reportError
}

Closing < close{
  closeEvent      Closed {}
}

Closed {}
}

```

Three Level FSM

The `ServerSession` class is part of a design pattern called Three Level FSM¹⁰. Using this pattern we split the finite state machine into three levels as shown in Figure 12-16. The first level is `ServerControllerContext`. This class contains one degenerate method for every action of the finite state machine. If you examine the code in Listing 12-28, you'll see all the empty methods. They are empty, instead of abstract, because SMC presumes that the context class is not abstract. In this class you'll also see the `FSMError` method. This method is called by the generated code whenever an event occurs in a state that did not expect it.

The generated code (Listing 12-46) creates the `ServerController` that derives from `ServerControllerContext`. It also creates `State` and all its derivatives. Finally, I wrote `ServerSession` to derive from `ServerController`. `ServerSession` implements all the degenerate methods of `ServerControllerContext`. As such it contains all of the detailed code that implements the behavior of the server. The code for this class is a bit long, but it's also quite simple. You'll find it in Listing 12-29.

UserRepository

I chose a very simple implementation for the `UserRepository` (See Listing 12-30). This class implements the `UserDirectory` interface and provides the means whereby the registration data is stored. I could have used a database for this, but the need was so simple that it didn't seem to make sense. So, instead, I create a directory named `users`. Inside this directory I create a file for each user. The name of the file is the email address of the user. The contents of the file are a simple XML record that contains the user's email

10. [PLOP95], *Discovering Patterns in Existing Applications*, Robert C. Martin, p383

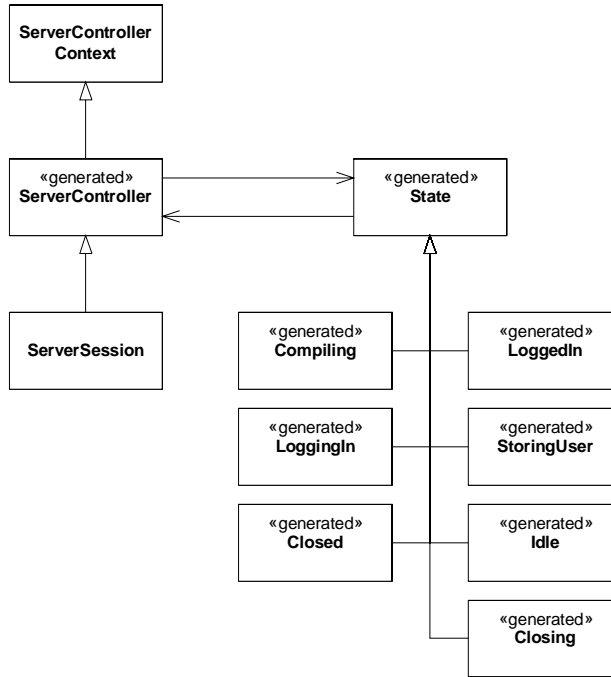

Figure 12-16
Three Level Finite State Machine.

Listing 12-28
ServerControllerContext.java

```

package com.objectmentor.SMCRemote.server;

public class ServerControllerContext {
    public void FSMError(String event, String state) {
        SMCRemoteService.verboseMessage("Transition Error. Event:" + event + " in state:" +
state);
    }

    public void checkValidUser() {
    }

    public void close() {
    }

    public void acknowledgeLogin() {
    }

    public void rejectLogin() {
    }
}

```

Listing 12-28 (Continued)
ServerControllerContext.java

```
public void doCompile() {
}

public void sendCompileResults() {
}

public void sendCompileRejection() {
}

public void sendCompileError() {
}

public void reportError() {
}

public void confirmRegistration() {
}

public void denyRegistration() {
}

public void storeUserAndSendPassword() {
}
}
```

Listing 12-29
ServerSession.java

```
package com.objectmentor.SMCRemote.server;

import com.objectmentor.SMCRemote.transactions.*;

import java.io.*;
import java.net.*;

class ServerSession extends ServerController {
    private ObjectOutputStream serverOutput;
    private ObjectInputStream serverInput;
    private String itsSessionID;
    private Socket itsSocket;
    private Exception itsException;
    private SMCRemoteServer itsParent;

    private String registrationFailureReason = null;

    private CompileFileTransaction cft;
    private File tempDirectory;
    private CompilerResultsTransaction crt;
    private LoginTransaction lt;
    private RegistrationTransaction rt;

    public ServerSession(SMCRemoteServer parent, Socket socket) throws IOException {
        itsParent = parent;
        itsSocket = socket;
        buildSessionID();
        serverOutput = new ObjectOutputStream(itsSocket.getOutputStream());
    }
}
```

Listing 12-29 (Continued)
ServerSession.java

```

    serverInput = new ObjectInputStream(itsSocket.getInputStream());
}

public ObjectInputStream initializeSession(Socket socket) throws IOException {
    serverOutput.writeObject("SMCR Server. " + SMCRemoteService.VERSION);
    writeMessageFile();
    serverOutput.flush();
    return serverInput;
}

private void writeMessageFile() throws IOException {
    if (SMCRemoteService.messageFile == null) {
        serverOutput.writeObject(null);
    } else {
        StringBuffer b = new StringBuffer();
        BufferedReader br = new BufferedReader(new FileReader(SMCRemoteService.messageFile));
        String line;
        while ((line = br.readLine()) != null)
            b.append(line + "\n");
        serverOutput.writeObject(b.toString());
    }
}

public void compileEvent(CompileFileTransaction cft) {
    this.cft = cft;
    compileEvent();
}

public void loginEvent(LoginTransaction lt) {
    this.lt = lt;
    loginEvent();
}

public void registerEvent(RegistrationTransaction rt) {
    this.rt = rt;
    verboseMessage(rt.getUsername() + " requests registration.");
    registerEvent();
}

public String generatePassword() {
    verboseMessage("Generating password.");
    return PasswordGenerator.generatePassword();
}

public void storeUserAndSendPassword() {
    String password = generatePassword();
    String username = rt.getUsername();
    try {
        boolean stored = SMCRemoteService.addUser(username, password);
        if (stored) {
            verboseMessage("User stored. Sending password email.");
            boolean emailSent = sendPasswordEmail(username, password);
            if (emailSent)
                userStoredEvent();
        } else {

```

Listing 12-29 (Continued)
ServerSession.java

```

        verboseMessage("could not send email.");
        registrationFailureReason = "could not send email.";
        sendFailedEvent();
    }
    } else {
        verboseMessage("Duplicate Registration");
        password = SMCRemoteService.getPassword(username);
        resendPasswordEmail(username, password);
        registrationFailureReason = "already a member. Email resent.";
        userNotStoredEvent();
    }
    } catch (Exception e) {
        abort(e);
    }
}

private boolean resendPasswordEmail(String username, String password) {
    return SMCRemoteService.sendEmail(username,
                                       "SMCRemote Resending password",
                                       "Your SMCRemote password is: " + password);
}

private boolean sendPasswordEmail(String username, String password) {
    return SMCRemoteService.sendEmail(username,
                                       "SMCRemote Registration Confirmation",
                                       "Your password is: " + password);
}

public void confirmRegistration() {
    verboseMessage("Confirming registration.");
    try {
        RegistrationResponseTransaction rrt = new RegistrationResponseTransaction(true);
        sendToClient(rrt);
    } catch (Exception e) {
        abort(e);
    }
}

public void denyRegistration() {
    verboseMessage("Registration Denied: " + registrationFailureReason);
    try {
        RegistrationResponseTransaction rrt = new RegistrationResponseTransaction(false);
        rrt.setFailureReason(registrationFailureReason);
        sendToClient(rrt);
    } catch (IOException e) {
        abort(e);
    }
}

public void checkValidUser() {
    String userName = lt.getUserName();
    String password = lt.getPassword();
    if (SMCRemoteService.validate(userName, password))
        validUserEvent();
    else

```

Listing 12-29 (Continued)
ServerSession.java

```

        invalidUserEvent();
    }

    public void close() {
        itsParent.close();
        closeEvent();
    }

    public void acknowledgeLogin() {
        try {
            int logins = SMCRemoteService.incrementLoginCount(lt.getUserName());
            verboseMessage("Login(" + logins + "): " + lt.getUserName() + " accepted.");
            LoginResponseTransaction lrt = new LoginResponseTransaction(true, logins);
            sendToClient(lrt);
        } catch (Exception e) {
            abort(e);
        }
    }

    public void rejectLogin() {
        verboseMessage("Login: " + lt.getUserName() + " rejected.");
        try {
            LoginResponseTransaction lrt = new LoginResponseTransaction(false, 0);
            sendToClient(lrt);
        } catch (IOException e) {
            abort(e);
        }
    }

    public void doCompile() {
        verboseMessage("Compiling: " + cft.getFilename() + " using " + cft.getGenerator() + "
generator.");

        try {
            tempDirectory = SMCRemoteService.makeTempDirectory();
            cft.write(tempDirectory);

            compile();
            goodCompileEvent();
        } catch (Exception e) {
            abort(e);
        }
    }

    public void sendCompileResults() {
        try {
            sendCompilerResultsToClient();
            tempDirectory.delete();
        } catch (IOException e) {
            abort(e);
        }
    }

    public void sendCompileRejection() {
        verboseMessage("Not logged in, can't compile.");
    }

```

Listing 12-29 (Continued)
ServerSession.java

```

    CompilerResultsTransaction crt = new CompilerResultsTransaction();
    crt.setStatus(CompilerResultsTransaction.NOT_LOGGED_IN);
    try {
        sendToClient(crt);
    } catch (IOException e) {
        abort(e);
    }
}

public void sendCompileError() {

}

public void reportError() {
    System.out.println("Aborting: " + itsException);
}

private void abort(Exception e) {
    itsException = e;
    abortEvent();
}

private void buildSessionID() {
    InetAddress addr = itsSocket.getInetAddress();
    String connectedHostName = addr.getHostName();
    String connectedIP = addr.getHostAddress();
    if (connectedHostName.equals(connectedIP)) {
        itsSessionID = connectedHostName + ":" + itsSocket.getPort();
    } else {
        itsSessionID =
            connectedHostName + ":" + itsSocket.getPort() + "(" + connectedIP + ")";
    }
}

private void compile() throws Exception {
    String filename = cft.getFilename();
    crt = new CompilerResultsTransaction();
    File batFile = writeCompileScript();

    SMCRemoteService.executeCommand(tempDirectory + "\\smc.bat", crt.getStdoutLines(),
        crt.getStderrLines());

    batFile.delete();
    File sourceFile = new File(tempDirectory, filename);
    sourceFile.delete();
}

private File writeCompileScript() throws IOException {
    File batFile = new File(tempDirectory, "smc.bat");
    PrintWriter bat = new PrintWriter(new FileWriter(batFile));
    bat.println("cd " + tempDirectory);
    bat.println(SMCRemoteService.buildCommand(cft.getFilename(), cft.getGenerator()));
    bat.close();
    return batFile;
}

```

Listing 12-29 (Continued)
ServerSession.java

```

private void sendCompilerResultsToClient() throws IOException {
    String[] filenames = tempDirectory.list();
    crt.loadFiles(tempDirectory, filenames);
    crt.setStatus(CompilerResultsTransaction.OK);
    verboseSendFileReport(filenames);
    sendToClient(crt);
    deleteCompiledFiles(filenames);
}

private void sendToClient(SocketTransaction t) throws IOException {
    serverOutput.writeObject(t);
    serverOutput.flush();
}

private void deleteCompiledFiles(String[] filenames) {
    for (int i = 0; i < filenames.length; i++) {
        File f = new File(tempDirectory, filenames[i]);
        f.delete();
    }
}

private void verboseSendFileReport(String[] filenames) {
    for (int i = 0; i < filenames.length; i++) {
        String filename = filenames[i];
        verboseMessage("Sending: " + filename);
    }
}

public void verboseMessage(String msg) {
    SMCRemoteService.verboseMessage("<" + itsSessionID + "> " + msg);
}
}

```

address, password, and a count of the number of times the user has logged in. This file is created upon registration, and is referenced every time the user logs in.

You might wonder why I didn't use a database, or some other more traditional scheme. The answer is simply that a database wasn't necessary. The kind of data I am storing is very simple; and does not require SQL or any of the other features of a database.

You might also ask why I chose to use XML. It turns out that JDOM is very simple to use, and it allowed me to create user records that were flexible. I could add new fields or change existing fields without a lot of fuss.

Listing 12-30
UserRepository.java

```

package com.objectmentor.SMCRemote.server;

import org.jdom.*;
import org.jdom.input.SAXBuilder;
import org.jdom.output.XMLOutputter;

import java.io.*;

```

Listing 12-30 (Continued)
UserRepository.java

```
public class UserRepository implements UserDirectory {

    class User {
        public User() {
        }

        public User(String username, String password, int loginCount) {
            this.username = username;
            this.password = password;
            this.loginCount = loginCount;
        }

        String username;
        String password;
        int loginCount;
    }

    private File userDirectory;

    public UserRepository(String userDirectoryName) {
        userDirectory = makeUserDirectory(userDirectoryName);
    }

    private File makeUserDirectory(String userDirectoryName) {
        File directory = new File(userDirectoryName);
        if (!directory.exists())
            directory.mkdir();
        return directory;
    }

    public boolean isValid(String username, String password) {
        return password.equals(getPassword(username));
    }

    public String getPassword(String username) {
        User user = readUser(username);
        return user.password;
    }

    private User readUser(String username) {
        User user = new User();
        try {
            File userFile = new File(userDirectory, username);
            if (userFile.canRead()) {
                SAXBuilder builder = new SAXBuilder("org.apache.xerces.parsers.SAXParser");
                Document userDoc = builder.build(userFile);
                Element userElement = userDoc.getRootElement();
                user.username = userElement.getChild("name").getTextTrim();
                user.password = userElement.getChild("password").getTextTrim();
                user.loginCount =
                    Integer.parseInt(userElement.getChild("loginCount").getTextTrim());
            }
        } catch (JDOMException e) {
            System.out.println("e = " + e);
        }
    }
}
```

Listing 12-30 (Continued)
UserRepository.java

```

        return null;
    }
    return user;
}

public boolean add(String username, String password) throws Exception {
    File userFile = new File(userDirectory, username);
    if (userFile.exists() == false) {
        User user = new User(username, password, 0);
        writeUser(user);
        return true;
    } else {
        return false;
    }
}

private void writeUser(User user) throws IOException {
    File userFile = new File(userDirectory, user.username);
    FileOutputStream os = new FileOutputStream(userFile);
    Document userDoc = createUserDocument(user);
    XMLOutputter xmlOut = new XMLOutputter();
    xmlOut.output(userDoc, os);
    os.close();
}

private Document createUserDocument(User user) {
    Element userElement = new Element("user");
    userElement.addContent(new Element("name").setText(user.username));
    userElement.addContent(new Element("password").setText(user.password));
    userElement.addContent(
        new Element("loginCount").setText(Integer.toString(user.loginCount)));
    Document userDoc = new Document(userElement);
    return userDoc;
}

public boolean clearUserRepository() {
    boolean cleared = true;
    File files[] = userDirectory.listFiles();
    for (int i = 0; i < files.length; i++) {
        File file = files[i];
        if (file.delete() == false)
            cleared = false;
    }
    if (userDirectory.delete() == false)
        cleared = false;
    return cleared;
}

public int incrementLoginCount(String username) throws Exception {
    User user = readUser(username);
    user.loginCount++;
    writeUser(user);
    return user.loginCount;
}
}

```

OReillyEmailSender

The `OReillyEmailSender` is a very simple FACADE¹¹ that gives the server access to email facilities. I chose to use the OReilly engine simply because I've used it before, and it seems to work just fine. See Listing 12-31.

Listing 12-31**OReillyEmailSender.java**

```
package com.objectmentor.SMCRemote.server;

import com.oreilly.servlet.MailMessage;

import java.io.*;

public class OReillyEmailSender implements EmailSender {
    public boolean send(String emailAddress, String subject, String text) {
        try {
            MailMessage msg = new MailMessage("cvs.objectmentor.com");
            msg.from("info@objectmentor.com");
            msg.to(emailAddress);
            msg.setSubject(subject);
            PrintStream body = msg.getPrintStream();
            body.println(text);
            msg.sendAndClose();
            return true;
        } catch (IOException e) {
            System.err.println("Couldn't send email: " + e.getMessage());
            return false;
        }
    }
}
```

PasswordGenerator

The `PasswordGenerator` class is also very simple and straightforward. This class is used to generate a password for a newly registered user. See Listing 12-32.

Listing 12-32**PasswordGenerator.java**

```
package com.objectmentor.SMCRemote.server;

public class PasswordGenerator {
    public static String generatePassword() {
        StringBuffer password = new StringBuffer();
        for (int i = 0; i < 8; i++) {
            password.append(generateRandomCharacter());
        }
        return password.toString();
    }
}
```

11. The Facade design pattern is explained in [GOF95] p. 185. There is a nice example and explanation of Facade in [PPP2002] p. 173

Listing 12-32 (Continued)
PasswordGenerator.java

```
private static char generateRandomCharacter() {  
    double x = Math.random();  
    x *= 26;  
    return (char) ('a' + x);  
}
```

Conclusion.

That's all there is to the `SMCRemote` system. All-in-all, including tests, the system is around 3,000 lines of code with an average cyclomatic complexity of 1.48.

The UML diagrams in this chapter are examples of the kinds of diagrams one might draw in order to explain an existing system to someone else. I kept my diagrams terse, and I tried not to inundate you with them. Mostly they are just there to help you read the code.

Tests for SMCRemoteClient

Listing 12-33
TestClientBase.java

```
package com.objectmentor.SMCRemote.client;

import junit.framework.TestCase;

import com.objectmentor.SMCRemote.transactions.*;
import com.objectmentor.SocketService.SocketServer;

import java.io.*;
import java.net.Socket;

abstract class MockServerBase implements SocketServer {
    private ObjectOutputStream os;
    private ObjectInputStream is;

    public abstract SocketTransactionProcessor getProcessor();

    public void sendTransaction(SocketTransaction t) throws Exception {
        os.writeObject(t);
        os.flush();
    }

    public void serve(Socket socket) {
        try {
            os = new ObjectOutputStream(socket.getOutputStream());
            is = new ObjectInputStream(socket.getInputStream());
            os.writeObject("SMCR Test Server");
            os.writeObject(null);
            os.flush();
            while (true) {
                SocketTransaction t = (SocketTransaction) is.readObject();
                t.accept(getProcessor());
            }
        } catch (Exception e) {
        }
    }
}

public class TestClientBase extends TestCase {
    public static final int SMCPOR = 9000;

    private ByteArrayOutputStream stdoutBuffer;
    private ByteArrayOutputStream stderrBuffer;

    public TestClientBase(String s) {
        super(s);
    }

    protected void setUp() throws Exception {
        stdoutBuffer = new ByteArrayOutputStream();
        stderrBuffer = new ByteArrayOutputStream();
    }
}
```

Listing 12-33 (Continued)
TestClientBase.java

```

protected String getStderr() {
    return stderrBuffer.toString();
}

protected String getStdout() {
    return stdoutBuffer.toString();
}

protected void runMain(String[] args) throws IOException {
    PrintStream sysout = System.out;
    PrintStream syserr = System.err;

    System.setOut(new PrintStream(stdoutBuffer));
    System.setErr(new PrintStream(stderrBuffer));

    SMCRemoteClient.main(args);
    System.setOut(sysout);
    System.setErr(syserr);

    stdoutBuffer.close();
    stderrBuffer.close();

    Thread.yield();
}
}

```

Listing 12-34
TestClientCommandLine.java

```

package com.objectmentor.SMCRemote.client;

import junit.framework.TestCase;
import junit.swingui.TestRunner;

public class TestClientCommandLine extends TestCase {
    public static void main(String[] args) {
        TestRunner.main(new String[]{"TestClientCommandLine"});
    }

    public TestClientCommandLine(String name) {
        super(name);
    }

    public void setUp() throws Exception {
    }

    public void tearDown() throws Exception {
    }

    public void testParseSimpleCompileCommandLine() throws Exception {
        ClientCommandLine c = new ClientCommandLine(new String[]{"-u", "user", "-w",
"password", "filename"});
        assertEquals("filename", c.getFilename());
        assertEquals(ClientCommandLine.DEFAULT_HOST, c.getHost());
        assertEquals(Integer.parseInt(ClientCommandLine.DEFAULT_PORT), c.getPort());
    }
}

```

Listing 12-34 (Continued)
TestClientCommandLine.java

```

    assertEquals(ClientCommandLine.DEFAULT_GENERATOR, c.getGenerator());
    assert(!c.isVerbose());
    assert("simple compile", c.isValid());
}

public void testParseComplexCompileCommandLine() throws Exception {
    ClientCommandLine c = new ClientCommandLine(new String[]{
        "-p", "999", "-h", "objectmentor.com", "-v", "-u", "user", "-w", "password",
        "-g", "C++", "f.sm"});
    assert(c.isValid());
    assertEquals("f.sm", c.getFilename());
    assertEquals("bad host", "objectmentor.com", c.getHost());
    assertEquals("bad port", 999, c.getPort());
    assertEquals("bad generator", "C++", c.getGenerator());
    assert("verbose", c.isVerbose());
}

public void testRegistrationCommandLine() throws Exception {
    ClientCommandLine c = new ClientCommandLine(new String[]{"-r", "user"});
    assert("registration commandline", c.isValid());
}

public void testParseInvalidCommandLine() {
    assert("no arguments", !checkCommandLine(new String[0]));
    assert("no filename", !checkCommandLine(new String[]{"-h", "dodah.com"}));
    assert("too many files", !checkCommandLine(new String[]{"file1", "file2"}));
    assert("Bad Argument", !checkCommandLine(new String[]{"-x", "file1"}));
    assert("Bad Port", !checkCommandLine(new String[]{"-p", "bad port"}));
    assert("generator but no file name", !checkCommandLine(new String[]{"-g", "C++"}));
    assert("filename but no user or password", !checkCommandLine(new String[]{"myFile"}));
    assert("filename but no user", !checkCommandLine(new String[]{"-w", "password",
"myFile"}));
    assert("filename but no password",
        !checkCommandLine(new String[]{"-u", "user", "myFile"}));
    assert("registration with user",
        !checkCommandLine(new String[]{"-r", "user", "-u", "user"}));
    assert("registration with password",
        !checkCommandLine(new String[]{"-r", "user", "-p", "password"}));
    assert("registration with generator",
        !checkCommandLine(new String[]{"-r", "user", "-g", "gen"}));
    assert("registration with file",
        !checkCommandLine(new String[]{"-r", "user", "myFile"}));
}

private boolean checkCommandLine(String[] args) {
    ClientCommandLine c = new ClientCommandLine(args);
    return c.isValid();
}
}

```

Listing 12-35
TestRemoteCompiler.java

```

package com.objectmentor.SMCRemote.client;

import junit.swingui.TestRunner;

```

Listing 12-35 (Continued)
TestRemoteCompiler.java

```

import com.objectmentor.SMCRemote.transactions.*;
import com.objectmentor.SocketService.SocketService;

import java.io.*;

class MockRemoteCompilerServer extends MockServerBase {
    public String filename = "noFileName";
    public boolean fileReceived = false;
    public String generator;
    public boolean isLoggedIn = false;

    class RemoteCompilerTransactionProcessor extends SocketTransactionProcessor {
        public void process(CompileFileTransaction t) throws Exception {
            try {
                File f1 = TestRemoteCompiler.createTestFile("myFile.java", "wow");
                File f2 = TestRemoteCompiler.createTestFile("file2.java", "ick");
                filename = t.getFilename();
                generator = t.getGenerator();

                CompilerResultsTransaction crt = new CompilerResultsTransaction();
                crt.loadFiles(null, new String[]{"myFile.java", "file2.java"});

                f1.delete();
                f2.delete();
                crt.getStdoutLines().add("compile diagnostics");
                crt.getStderrLines().add("stderr message");
                sendTransaction(crt);

                fileReceived = true;
            } catch (IOException e) {
            }
        }

        public void process(LoginTransaction t) throws Exception {
            LoginResponseTransaction lrt = new LoginResponseTransaction(true, 0);
            sendTransaction(lrt);
            isLoggedIn = true;
        }
    }

    public SocketTransactionProcessor getProcessor() {
        return new RemoteCompilerTransactionProcessor();
    }
}

public class TestRemoteCompiler extends TestClientBase {
    public static void main(String[] args) {
        TestRunner.main(new String[]{"com.objectmentor.SMCRemote.client.TestRemoteCompiler"});
    }

    public TestRemoteCompiler(String name) {
        super(name);
    }

    private RemoteCompiler c;

```

Listing 12-35 (Continued)
TestRemoteCompiler.java

```
private MockRemoteCompilerServer server;
private SocketService smc;

public void setUp() throws Exception {
    super.setUp();
    c = new RemoteCompiler("localhost", SMCPORT, new NullMessageLogger());
    server = new MockRemoteCompilerServer();
    smc = new SocketService(SMCPORT, server);
}

public void tearDown() throws Exception {
    c.close();
    smc.close();
}

static File createTestFile(String name, String content) throws IOException {
    File f = new File(name);
    FileOutputStream stream = new FileOutputStream(f);
    stream.write(content.getBytes());
    stream.close();
    return f;
}

public void testFileDoesNotExist() throws Exception {
    c.setFilename("thisFileDoesNotExist");
    boolean prepared = c.prepareFile();
    assertEquals(false, prepared);
}

public void testConnectToSMCRemoteServer() throws Exception {
    boolean connection = c.connect();
    assert(connection);
}

public void testCompileFile() throws Exception {
    String filename = "testSendFile";
    File f = createTestFile(filename, "I am sending this file.");
    c.setFilename(filename);
    assert(c.connect());
    assert(c.prepareFile());
    assert(c.compileFile() != null);
    Thread.sleep(50);
    assert(server.fileReceived);
    assertEquals(filename, server.filename);
    assertEquals("Bad Generator", "java", server.generator);
    f.delete();
}

public void testMainCompileFile() throws Exception {
    File f = createTestFile("myFile.sm", "the content");
    runMain(new String[]{"-u", "user", "-w", "pw", "-g", "C++", "myFile.sm"});

    f.delete();
    File file1 = new File("myFile.java");
    File file2 = new File("file2.java");
}
```

Listing 12-35 (Continued)
TestRemoteCompiler.java

```

boolean file1Exists = file1.exists();
boolean file2Exists = file2.exists();
boolean exists = file1Exists && file2Exists;

int file1Len = (int) file1.length();
int file2Len = (int) file2.length();

if (file1Exists) file1.delete();
if (file2Exists) file2.delete();

assert("Not logged in", server.isLoggedIn);
assert("not received", server.fileReceived);
assertEquals("bad generator", "C++", server.generator);
assert("One or more files doesn't exist", exists);
assert("f1 zero", file1Len > 0);
assert("f2 zero", file2Len > 0);

assert("consoleMessage", getStdout().startsWith("compile diagnostics"));
assert("Stderr Message", getStderr().startsWith("stderr message"));
}
}

```

Listing 12-36
TestRemoteRegistration.java

```

package com.objectmentor.SMCRemote.client;

import junit.swingui.TestRunner;

import com.objectmentor.SMCRemote.transactions.*;
import com.objectmentor.SocketService.SocketService;

class MockRemoteRegistrationServer extends MockServerBase {
    public String user;

    class RemoteRegistrationServerTransactionProcessor extends SocketTransactionProcessor {
        public void process(RegistrationTransaction t) throws Exception {
            user = t.getUsername();
            RegistrationResponseTransaction rrt;
            if (user.equals("goodUser")) {
                rrt = new RegistrationResponseTransaction(true);
            } else {
                rrt = new RegistrationResponseTransaction(false);
            }
            sendTransaction(rrt);
        }
    }

    public SocketTransactionProcessor getProcessor() {
        return new RemoteRegistrationServerTransactionProcessor();
    }
}

public class TestRemoteRegistration extends TestClientBase {
    public TestRemoteRegistration(String s) {

```

Listing 12-36 (Continued)
TestRemoteRegistration.java

```
    super(s);
}

public static void main(String[] args) {
    TestRunner.main(new
String[]{"com.objectmentor.SMCRemote.client.TestRemoteRegistration"});
}

private RemoteRegistrar r;
private MockRemoteRegistrationServer server;
private SocketService smc;

public void setUp() throws Exception {
    super.setUp();
    r = new RemoteRegistrar("localhost", SMCPORT, new NullMessageLogger());
    server = new MockRemoteRegistrationServer();
    smc = new SocketService(SMCPORT, server);
}

public void tearDown() throws Exception {
    r.close();
    smc.close();
}

public void testRegistration() throws Exception {
    RegistrationResponseTransaction rrt;
    assert(r.connect());
    rrt = r.register("goodUser");
    assert("rrt not null", rrt != null);
    assert("registration passed", rrt.isConfirmed());
    Thread.sleep(50);
    assertEquals("Registration", "goodUser", server.user);
}

public void testRegistrationMain() throws Exception {
    runMain(new String[]{"-r", "goodUser"});
    assert("Registration message",
        getStdout().startsWith("User: goodUser registered. Email sent.));
}
}
```

Tests for SocketService

Listing 12-37 TestSocketService.java

```
package com.objectmentor.SocketService;

import junit.framework.TestCase;
import junit.swingui.TestRunner;

import java.io.*;
import java.net.Socket;

public class TestSocketService extends TestCase {
    private int connections = 0;
    private SocketServer connectionCounter;
    private SocketService ss;

    public static void main(String[] args) {
        TestRunner.main(new String[] {
            "com.objectmentor.SocketService.TestSocketService"
        });
    }

    public TestSocketService(String name) {
        super(name);
        connectionCounter = new SocketServer() {
            public void serve(Socket s) {
                connections++;
            }
        };
    }

    public void setUp() throws Exception {
        connections = 0;
    }

    public void tearDown() throws Exception {
    }

    public void testNoConnections() throws Exception {
        ss = new SocketService(999, connectionCounter);
        ss.close();
        assertEquals(0, connections);
    }

    public void testOneConnection() throws Exception {
        ss = new SocketService(999, connectionCounter);
        connect(999);
        ss.close();
        assertEquals(1, connections);
    }

    public void testManyConnections() throws Exception {
        ss = new SocketService(999, connectionCounter);
        for (int i = 0; i < 10; i++)
            connect(999);
    }
}
```

Listing 12-37
TestSocketService.java

```
        ss.close();
        assertEquals(10, connections);
    }

    public void testSendMessage() throws Exception {
        ss = new SocketService(999, new HelloService());
        Socket s = new Socket("localhost", 999);
        BufferedReader br = TestUtility.GetBufferedReader(s);
        String answer = br.readLine();
        s.close();
        ss.close();
        assertEquals("Hello", answer);
    }

    public void testReceiveMessage() throws Exception {
        ss = new SocketService(999, new EchoService());
        Socket s = new Socket("localhost", 999);
        BufferedReader br = TestUtility.GetBufferedReader(s);
        PrintStream ps = TestUtility.GetPrintStream(s);
        ps.println("MyMessage");
        String answer = br.readLine();
        s.close();
        ss.close();
        assertEquals("MyMessage", answer);
    }

    public void testMultiThreaded() throws Exception {
        ss = new SocketService(999, new EchoService());
        Socket s = new Socket("localhost", 999);
        BufferedReader br = TestUtility.GetBufferedReader(s);
        PrintStream ps = TestUtility.GetPrintStream(s);

        Socket s2 = new Socket("localhost", 999);
        BufferedReader br2 = TestUtility.GetBufferedReader(s2);
        PrintStream ps2 = TestUtility.GetPrintStream(s2);

        ps2.println("MyMessage");
        String answer2 = br2.readLine();
        s2.close();

        ps.println("MyMessage");
        String answer = br.readLine();
        s.close();

        ss.close();
        assertEquals("MyMessage", answer2);
        assertEquals("MyMessage", answer);
    }

    private void connect(int port) {
        try {
            Socket s = new Socket("localhost", port);
            try {
                Thread.sleep(10);
            } catch (InterruptedException e) {
```

Listing 12-37
TestSocketService.java

```
        }
        s.close();
    } catch (IOException e) {
        fail("could not connect");
    }
}

class TestUtility {
    public static PrintStream GetPrintStream(Socket s)
    throws IOException {
        OutputStream os = s.getOutputStream();
        PrintStream ps = new PrintStream(os);
        return ps;
    }

    public static BufferedReader GetBufferedReader(Socket s)
    throws IOException {
        InputStream is = s.getInputStream();
        InputStreamReader isr = new InputStreamReader(is);
        BufferedReader br = new BufferedReader(isr);
        return br;
    }
}

class HelloService implements SocketServer {
    public void serve(Socket s) {
        try {
            PrintStream ps = TestUtility.GetPrintStream(s);
            ps.println("Hello");
        } catch (IOException e) {
        }
    }
}

class EchoService implements SocketServer {
    public void serve(Socket s) {
        try {
            PrintStream ps = TestUtility.GetPrintStream(s);
            BufferedReader br = TestUtility.GetBufferedReader(s);
            String token = br.readLine();
            ps.println(token);
        } catch (IOException e) {
        }
    }
}
```

Tests for SMCRemoteServer

Listing 12-38
TestBase.java

```
package com.objectmentor.SMCRemote.server;

import junit.framework.TestCase;

import com.objectmentor.SMCRemote.transactions.*;

import java.io.*;
import java.net.Socket;

class MockUserDirectory implements UserDirectory {
    public int incrementLoginCount(String username) {
        return 0;
    }

    public boolean isValid(String username, String password) {
        return true;
    }

    public String getPassword(String username) {
        return null;
    }

    public boolean add(String username, String password) {
        return true;
    }
}

public class TestBase extends TestCase {
    protected ObjectInputStream is;
    protected ObjectOutputStream os;
    protected SMCRemoteService service;
    protected Socket client;

    protected UserDirectory mockUserDirectory = new MockUserDirectory();

    protected UserDirectory mockUserInvalidator = new MockUserDirectory() {
        public boolean isValid(String username, String password) {
            return false;
        }
    };

    public TestBase(String name) {
        super(name);
    }

    public void setUp() throws Exception {
        SMCRemoteService.isVerbose = false;
    }

    public void tearDown() throws Exception {
    }
}
```

Listing 12-38 (Continued)**TestBase.java**

```

protected boolean login() throws IOException, ClassNotFoundException {
    LoginTransaction lt = new LoginTransaction("name", "password");
    sendToServer(lt);
    LoginResponseTransaction ltr = (LoginResponseTransaction) is.readObject();
    return ltr.isAccepted();
}

protected void sendToServer(SocketTransaction t) throws IOException {
    os.writeObject(t);
    os.flush();
}

protected void disconnectClientFromServer() throws Exception {
    Thread.sleep(500);
    client.close();
    service.close();
}

protected void connectClientToServer() throws Exception {
    service = new SMCRemoteService(999);
    client = new Socket("localhost", 999);
    is = new ObjectInputStream(client.getInputStream());
    os = new ObjectOutputStream(client.getOutputStream());

    String headerLine = (String) is.readObject();
    assert("headerline", headerLine.startsWith("SMCR Server"));
    assertEquals("discard message", null, is.readObject()); // discard message
}
}

```

Listing 12-39**TestCommandLine.java**

```

package com.objectmentor.SMCRemote.server;

public class TestCommandLine extends TestBase {
    public TestCommandLine(String name) {
        super(name);
    }

    public void tearDown() throws Exception {
        super.tearDown();
        SMCRemoteService.messageFile = null;
        SMCRemoteService.isVerbose = false;
        SMCRemoteService.servicePort = Integer.parseInt(SMCRemoteService.DEFAULT_PORT);
    }

    public void setUp() throws Exception {
        super.setUp();
    }

    public void testValidCommandLine() throws Exception {
        assert("Null Command Line", SMCRemoteService.parseCommandLine(new String[0]));
        assertEquals("default port",
            Integer.parseInt(SMCRemoteService.DEFAULT_PORT),
            SMCRemoteService.servicePort);
    }
}

```

Listing 12-39 (Continued)
TestCommandLine.java

```

assert("default verbose", SMCRemoteService.isVerbose == false);

assert("Parametric Command Line",
    SMCRemoteService.parseCommandLine(
        new String[]{"-p", "999", "-v", "-m", "message.txt", "-e"}));
assertEquals("port", 999, SMCRemoteService.servicePort);
assert("verbose", SMCRemoteService.isVerbose == true);
assertEquals("message", "message.txt", SMCRemoteService.messageFile);
assertEquals("email", true, SMCRemoteService.isEmailQuiet);
}

public void testInvalidCommandLine() throws Exception {
    assertEquals("Invalid Command Line",
        false, SMCRemoteService.parseCommandLine(new String[]{"-x"}));
    assertEquals("Bad Port",
        false, SMCRemoteService.parseCommandLine(new String[]{"-p", "badport"}));
}
}

```

Listing 12-40
TestCompilation.java

```

package com.objectmentor.SMCRemote.server;

import junit.swingui.TestRunner;

import com.objectmentor.SMCRemote.transactions.*;

import java.io.*;
import java.net.Socket;
import java.util.*;

public class TestCompilation extends TestBase {

    public static void main(String[] args) {
        TestRunner.main(new String[]{"TestCompilation"});
    }

    public TestCompilation(String name) {
        super(name);
    }

    public void setUp() throws Exception {
    }

    public void tearDown() throws Exception {
    }

    public void testBuildCommand() throws Exception {
        assertEquals("Build Java Command",
            SMCRemoteService.COMPILE_COMMAND +
                " -g smc.generator.java.SMJavaGenerator myFile",
            SMCRemoteService.buildCommand("myFile", "java"));

        assertEquals("Build C++ Command",
            SMCRemoteService.COMPILE_COMMAND +
                " -g smc.generator.cpp.SMCppGenerator myFile",

```

Listing 12-40 (Continued)
TestCompilation.java

```

        SMCRemoteService.buildCommand("myFile", "C++");
    }

    public void testExecuteCommand() throws Exception {
        File smFile = new File("myFile.sm");
        File javaFile = new File("F.java");

        writeSourceFile(smFile);
        Vector stdout = new Vector();
        Vector stderr = new Vector();
        String command = SMCRemoteService.COMPILE_COMMAND + " myFile.sm";
        assertEquals("exitValue", 0, SMCRemoteService.executeCommand(command, stdout, stderr));
        assertEquals("fileExists", true, javaFile.exists());
        assert("javaFile", javaFile.delete());
        assert("smFile", smFile.delete());
        checkCompilerOutputStreams(stdout, stderr);
    }

    public void testMakeTempDirectory() throws Exception {
        File f1 = SMCRemoteService.makeTempDirectory();
        File f2 = SMCRemoteService.makeTempDirectory();
        assertEquals("MakeTempDirectory", false, f1.getName().equals(f2.getName()));
        assert("f1", f1.delete());
        assert("f2", f2.delete());
    }

    public void testCompileJava() throws Exception {
        connectClientToServer();
        service.setUserDirectory(mockUserDirectory);
        login();
        CompilerResultsTransaction crt = invokeRemoteCompiler("java");
        assertEquals("Compiler Status", CompilerResultsTransaction.OK, crt.getStatus());
        checkCompiledJavaFile(crt);
        checkCompilerOutputStreams(crt.getStdoutLines(), crt.getStderrLines());
        disconnectClientFromServer();
    }

    public void testCompileCPP() throws Exception {
        connectClientToServer();
        service.setUserDirectory(mockUserDirectory);
        login();
        CompilerResultsTransaction crt = invokeRemoteCompiler("C++");
        assertEquals("Compiler Status", CompilerResultsTransaction.OK, crt.getStatus());
        checkCompiledCPPFile(crt);
        checkCompilerOutputStreams(crt.getStdoutLines(), crt.getStderrLines());
        disconnectClientFromServer();
    }

    public void testCompileNoLogin() throws Exception {
        connectClientToServer();
        service.setUserDirectory(mockUserDirectory);
        CompilerResultsTransaction crt = invokeRemoteCompiler("java");
        disconnectClientFromServer();
        assertEquals("Compiler Status", CompilerResultsTransaction.NOT_LOGGED_IN,
            crt.getStatus());
    }

```

Listing 12-40 (Continued)
TestCompilation.java

```

    }

    public void testTwoCompilesInARowNotAllowed() throws Exception {
        connectClientToServer();
        service.setUserDirectory(mockUserDirectory);
        login();
        CompilerResultsTransaction crt = invokeRemoteCompiler("java");
        try {
            crt = invokeRemoteCompiler("java");
            fail("Two Compiles in a row");
        } catch (Exception e) {
        } finally {
            disconnectClientFromServer();
        }
    }

    public void testCloseServer() throws Exception {
        try {
            service = new SMCRemoteService(999);
            client = new Socket("localhost", 999);
            client.close();
            service.close();
        } catch (Exception e) {
            fail("couldn't connect" + e.getMessage());
        }
        try {
            client = new Socket("localhost", 999);
            fail("connected to closed server");
        } catch (Exception e) {
        }
    }

    protected CompilerResultsTransaction
    invokeRemoteCompiler(String generator) throws Exception {
        CompileFileTransaction cft = buildCompileFileTransaction(generator);
        sendToServer(cft);
        CompilerResultsTransaction crt = (CompilerResultsTransaction) is.readObject();
        return crt;
    }

    protected CompileFileTransaction
    buildCompileFileTransaction(String generator) throws IOException {
        File sourceFile = new File("myFile.sm");
        writeSourceFile(sourceFile);
        CompileFileTransaction cft = new CompileFileTransaction("myFile.sm", generator);
        sourceFile.delete();
        return cft;
    }

    protected void writeSourceFile(File smFile) throws IOException {
        PrintWriter w = new PrintWriter(new FileWriter(smFile));
        w.println("Context C");
        w.println("FSMName F");
        w.println("Initial I");
        w.println("I{E I A}");
        w.close();
    }

```

Listing 12-40 (Continued)
TestCompilation.java

```

    }

    protected void checkCompilerOutputStreams(Vector stdout, Vector stderr) {
        assert("stdout empty", stdout.size() > 0);
        assert("stderr not empty", stderr.size() == 0);
    }

    protected void checkCompiledJavaFile(CompilerResultsTransaction crt) {
        String filenames[] = crt.getFileNames();
        assertEquals("filenames", 1, filenames.length);
        assertEquals("F.java", "F.java", filenames[0]);

        crt.write();

        File javaFile = new File("F.java");
        assertEquals("Compile", true, javaFile.exists());
        javaFile.delete();
    }

    protected void checkCompiledCPPFile(CompilerResultsTransaction crt) {
        String filenames[] = crt.getFileNames();
        Arrays.sort(filenames);
        assertEquals("filenames", 2, filenames.length);
        assertEquals("myFile.cpp", "myFile.cpp", filenames[0]);
        assertEquals("myFile.h", "myFile.h", filenames[1]);

        crt.write();

        File cppHFile = new File("myFile.h");
        File cppCFile = new File("myFile.cpp");
        assertEquals("Compile", true, cppHFile.exists() && cppCFile.exists());
        cppHFile.delete();
        cppCFile.delete();
    }
}

```

Listing 12-41
TestOReillyEmail.java

```

package com.objectmentor.SMCRemote.server;

import junit.framework.TestCase;
import junit.swingui.TestRunner;

public class TestOReillyEmail extends TestCase {
    public static void main(String[] args) {
        TestRunner.main(new String[]{"TestOReillyEmail"});
    }

    public TestOReillyEmail(String name) {
        super(name);
    }

    public void setUp() throws Exception {
    }
}

```

Listing 12-41 (Continued)
TestOReillyEmail.java

```

public void tearDown() throws Exception {
}

public void testSendEmail() throws Exception {
    boolean emailStatus = false;
    OReillyEmailSender sender = new OReillyEmailSender();
    emailStatus = sender.send("unclebob@objectmentor.com", "hi bob", "oh boy, email!");
    assertEquals("SendEmail", true, emailStatus);
}
}

```

Listing 12-42
TestRegistration.java

```

package com.objectmentor.SMCRemote.server;

import com.objectmentor.SMCRemote.transactions.*;

public class TestRegistration extends TestBase {
    private String emailAddress;
    private String mailSubject;
    private String mailText;
    private int emailMessagesSent = 0;

    private EmailSender mockEmailSender = new EmailSender() {
        public boolean send(String emailAddress, String subject, String text) {
            TestRegistration.this.emailAddress = emailAddress;
            TestRegistration.this.mailSubject = subject;
            TestRegistration.this.mailText = text;
            emailMessagesSent++;
            return true;
        }
    };

    private EmailSender mockBadEmailSender = new EmailSender() {
        public boolean send(String emailAddress, String subject, String text) {
            return false;
        }
    };

    private RegistrationResponseTransaction rrt;
    private UserRepository userRepository;
    private String userRepositoryName = "testUsers";

    public TestRegistration(String name) {
        super(name);
    }

    public void tearDown() throws Exception {
        super.tearDown();
        userRepository.clearUserRepository();
    }

    public void setUp() throws Exception {
        super.setUp();
        userRepository = new UserRepository(userRepositoryName);
    }
}

```

Listing 12-42 (Continued)
TestRegistration.java

```

public void testRegistration() throws Exception {
    sendRegistration(mockEmailSender);
    assertEquals("emailAddress", "rmartin@oma.com", emailAddress);
    assertEquals("mailSubject", "SMCRemote Registration Confirmation", mailSubject);
    assert("Mail Text", mailText.startsWith("Your password is: "));
    assertEquals("Mail Text Length", 26, mailText.length());
    assertEquals("Registration", true, rrt.isConfirmed());
    String password = mailText.substring(18);
    assertEquals("User Registered",
        true, SMCRemoteService.validate("rmartin@oma.com", password));
    assertEquals("email count", 1, emailMessagesSent);
}

public void testBadEmail() throws Exception {
    sendRegistration(mockBadEmailSender);
    assertEquals("Registration", false, rrt.isConfirmed());
    assertEquals("Reason", "could not send email.", rrt.getFailureReason());
}

public void testDoubleRegistration() throws Exception {
    sendRegistration(mockEmailSender);
    sendRegistration(mockEmailSender);
    assertEquals("second registration", false, rrt.isConfirmed());
    assertEquals("second registration reason",
        "already a member. Email resent.", rrt.getFailureReason());
    assertEquals("emailAddress", "rmartin@oma.com", emailAddress);
    assertEquals("emailSubject", "SMCRemote Resending password", mailSubject);
    assert("emailText", mailText.startsWith("Your SMCRemote password is: "));
    assertEquals("emailTextLength", 36, mailText.length());
    assertEquals("emailCount", 2, emailMessagesSent);
}

private void sendRegistration(EmailSender emailSender) throws Exception {
    connectClientToServer();
    service.setEmailSender(emailSender);
    service.setUserDirectory(userRepository);
    try {
        RegistrationTransaction rt = new RegistrationTransaction("rmartin@oma.com");
        sendToServer(rt);
        rrt = (RegistrationResponseTransaction) is.readObject();
    } finally {
        disconnectClientFromServer();
    }
}
}

```

Listing 12-43
TestServerLogin.java

```

package com.objectmentor.SMCRemote.server;

public class TestServerLogin extends TestBase {
    public TestServerLogin(String name) {
        super(name);
    }
}

```

Listing 12-43 (Continued)
TestServerLogin.java

```
}

public void setUp() throws Exception {
    super.setUp();
}

public void tearDown() throws Exception {
    super.tearDown();
}

public void testAcceptedLoginTransaction() throws Exception {
    boolean loggedIn = false;
    try {
        connectClientToServer();
        service.setUserDirectory(mockUserDirectory);
        loggedIn = login();
        disconnectClientFromServer();
    } catch (Exception e) {
    }

    assertEquals("LoginTransaction", true, loggedIn);
}

public void testRejectedLoginTransaction() throws Exception {
    boolean loggedIn = false;
    try {
        connectClientToServer();
        service.setUserDirectory(mockUserInvalidator);
        loggedIn = login();
        disconnectClientFromServer();
    } catch (Exception e) {
    }

    assertEquals("LoginTransaction", false, loggedIn);
}
}
```

Listing 12-44
TestUserRepository.java

```
package com.objectmentor.SMCRemote.server;

import junit.framework.TestCase;
import junit.swingui.TestRunner;

public class TestUserRepository extends TestCase {
    private UserRepository repository;

    public static void main(String[] args) {
        TestRunner.main(new String[]{"TestUserRepository"});
    }

    public TestUserRepository(String name) {
        super(name);
    }
}
```

Listing 12-44 (Continued)
TestUserRepository.java

```
public void setUp() throws Exception {
    repository = new UserRepository("testUsers");
}

public void tearDown() throws Exception {
    assert("Repository not cleared", repository.clearUserRepository());
}

public void testEmptyRepository() throws Exception {
    assertEquals("EmptyRepository", false, repository.isValid("rmartin@oma.com",
"password"));
}

public void testAdd() throws Exception {
    repository.add("rmartin@oma.com", "password");
    assertEquals("Add", true, repository.isValid("rmartin@oma.com", "password"));
}

public void testwrongPassword() throws Exception {
    assertEquals("addFailed", true, repository.add("rmartin@oma.com", "password"));
    assertEquals("wrongPassword", false, repository.isValid("rmartin@oma.com", "xyzyz"));
}

public void testDuplicateAdd() throws Exception {
    assertEquals("FirstAdd", true, repository.add("rmartin@oma.com", "password"));
    assertEquals("DuplicateAdd", false, repository.add("rmartin@oma.com", "password"));
}

public void testIncrement() throws Exception {
    int logins = 0;
    repository.add("rmartin@oma.com", "password");
    logins = repository.incrementLoginCount("rmartin@oma.com");
    assertEquals("Increment", 1, logins);
    logins = repository.incrementLoginCount("rmartin@oma.com");
    assertEquals("Increment2", 2, logins);
}
}
```

Other Tests

Listing 12-45
TestFileCarrier.java

```
package com.objectmentor.SocketUtilities;

import junit.framework.TestCase;
import junit.swingui.TestRunner;

import java.io.*;

public class TestFileCarrier extends TestCase {
    public static void main(String[] args) {
        TestRunner.main(new String[]{"TestFileCarrier"});
    }

    public TestFileCarrier(String name) {
        super(name);
    }

    public void setUp() throws Exception {
    }

    public void tearDown() throws Exception {
    }

    private abstract class FileComparator {
        File f1;
        File f2;

        abstract void writeFirstFile(PrintWriter w);

        abstract void writeSecondFile(PrintWriter w);

        void compare(boolean expected) throws Exception {
            f1 = new File("f1");
            f2 = new File("f2");
            PrintWriter w1 = new PrintWriter(new FileWriter(f1));
            PrintWriter w2 = new PrintWriter(new FileWriter(f2));
            writeFirstFile(w1);
            writeSecondFile(w2);
            w1.close();
            w2.close();
            assertEquals("(f1,f2)", expected, filesAreTheSame(f1, f2));
            assertEquals("(f2,f1)", expected, filesAreTheSame(f2, f1));
            f1.delete();
            f2.delete();
        }
    }

    public void testOneFileLongerThanTheOther() throws Exception {
        FileComparator c = new FileComparator() {
            void writeFirstFile(PrintWriter w) {
                w.println("hi there");
            }
        }
    }
}
```

Listing 12-45 (Continued)
TestFileCarrier.java

```
        void writeSecondFile(PrintWriter w) {
            w.println("hi there you");
        }
    };
    c.compare(false);
}

public void testFilesAreDifferentInTheMiddle() throws Exception {
    FileComparator c = new FileComparator() {
        void writeFirstFile(PrintWriter w) {
            w.println("hi there");
        }

        void writeSecondFile(PrintWriter w) {
            w.println("hi their");
        }
    };
    c.compare(false);
}

public void testSecondLineDifferent() throws Exception {
    FileComparator c = new FileComparator() {
        void writeFirstFile(PrintWriter w) {
            w.println("hi there");
            w.println("This is fun");
        }

        void writeSecondFile(PrintWriter w) {
            w.println("hi there");
            w.println("This isn't fun");
        }
    };
    c.compare(false);
}

public void testFilesSame() throws Exception {
    FileComparator c = new FileComparator() {
        void writeFirstFile(PrintWriter w) {
            w.println("hi there");
        }

        void writeSecondFile(PrintWriter w) {
            w.println("hi there");
        }
    };
    c.compare(true);
}

public void testMultipleLinesSame() throws Exception {
    FileComparator c = new FileComparator() {
        void writeFirstFile(PrintWriter w) {
            w.println("hi there");
            w.println("this is fun");
            w.println("Lots of fun");
        }
    }
}
```

Listing 12-45 (Continued)
TestFileCarrier.java

```
        void writeSecondFile(PrintWriter w) {
            w.println("hi there");
            w.println("this is fun");
            w.println("Lots of fun");
        }
    };
    c.compare(true);
}

public void testFileCarrier() throws Exception {
    File sourceFile = new File("testFileCarrier.txt");
    PrintWriter w = new PrintWriter(new FileWriter(sourceFile));
    w.println("line one");
    w.println("line two");
    w.println("line three");
    w.close();

    FileCarrier fc = new FileCarrier(null, "testFileCarrier.txt");
    assert(fc.isError() == false);
    assert(fc.isLoaded() == true);

    File tmpDirectory = new File("tmpDirectory");
    tmpDirectory.mkdir();

    File newFile = new File("tmpDirectory/testFileCarrier.txt");

    fc.write(tmpDirectory);

    assert("file wasn't written", newFile.exists());
    assert("files aren't the same.", filesAreTheSame(newFile, sourceFile));

    assert("newfile", newFile.delete());
    assert("oldFile", sourceFile.delete());
    assert("directory", tmpDirectory.delete());
}

boolean filesAreTheSame(File f1, File f2) throws Exception {
    FileInputStream r1 = new FileInputStream(f1);
    FileInputStream r2 = new FileInputStream(f2);
    try {
        int c;
        while ((c = r1.read()) != -1) {
            if (r2.read() != c) {
                return false;
            }
        }
        if (r2.read() != -1)
            return false;
        else
            return true;
    } finally {
        r1.close();
        r2.close();
    }
}
```

Listing 12-45 (Continued)
TestFileCarrier.java

```
}  
}
```

ServerController (SMC Generated)

Listing 12-46
ServerController.java

```
//-----  
//  
// FSM:      ServerController  
// Context:  ServerControllerContext  
// Err Func: FSMError  
// Version:  
// Generated: Wednesday 11/13/2002 at 20:32:13 CST  
//  
//-----  
  
package com.objectmentor.SMCRemote.server;  
  
//-----  
//  
// class ServerController  
//   This is the Finite State Machine class  
//  
public class ServerController extends ServerControllerContext {  
    private State itsState;  
    private static String itsVersion = "";  
  
    // instance variables for each state  
    private LoggedIn itsLoggedInState;  
    private StoringUser itsStoringUserState;  
    private Idle itsIdleState;  
    private Closing itsClosingState;  
    private Compiling itsCompilingState;  
    private LoggingIn itsLoggingInState;  
    private Closed itsClosedState;  
  
    // constructor  
    public ServerController() {  
        itsLoggedInState = new LoggedIn();  
        itsStoringUserState = new StoringUser();  
        itsIdleState = new Idle();  
        itsClosingState = new Closing();  
        itsCompilingState = new Compiling();  
        itsLoggingInState = new LoggingIn();  
        itsClosedState = new Closed();  
  
        itsState = itsIdleState;  
  
        // Entry functions for: Idle  
    }  
}
```

Listing 12-46 (Continued)
ServerController.java

```
// accessor functions

public String getVersion() {
    return itsVersion;
}

public String getCurrentStateName() {
    return itsState.stateName();
}

// event functions - forward to the current State

public void userStoredEvent() {
    itsState.userStoredEvent();
}

public void badCompileEvent() {
    itsState.badCompileEvent();
}

public void invalidUserEvent() {
    itsState.invalidUserEvent();
}

public void compileEvent() {
    itsState.compileEvent();
}

public void loginEvent() {
    itsState.loginEvent();
}

public void abortEvent() {
    itsState.abortEvent();
}

public void registerEvent() {
    itsState.registerEvent();
}

public void closeEvent() {
    itsState.closeEvent();
}

public void userNotStoredEvent() {
    itsState.userNotStoredEvent();
}

public void sendFailedEvent() {
    itsState.sendFailedEvent();
}

public void goodCompileEvent() {
    itsState.goodCompileEvent();
}
```

Listing 12-46 (Continued)
ServerController.java

```
}

public void validUserEvent() {
    itsState.validUserEvent();
}

//-----
//
// private class State
//   This is the base State class
//
private abstract class State {
    public abstract String stateName();

    // default event functions

    public void userStoredEvent() {
        FSMEError("userStoredEvent", itsState.stateName());
    }

    public void badCompileEvent() {
        FSMEError("badCompileEvent", itsState.stateName());
    }

    public void invalidUserEvent() {
        FSMEError("invalidUserEvent", itsState.stateName());
    }

    public void compileEvent() {
        FSMEError("compileEvent", itsState.stateName());
    }

    public void loginEvent() {
        FSMEError("loginEvent", itsState.stateName());
    }

    public void abortEvent() {
        FSMEError("abortEvent", itsState.stateName());
    }

    public void registerEvent() {
        FSMEError("registerEvent", itsState.stateName());
    }

    public void closeEvent() {
        FSMEError("closeEvent", itsState.stateName());
    }

    public void userNotStoredEvent() {
        FSMEError("userNotStoredEvent", itsState.stateName());
    }

    public void sendFailedEvent() {
        FSMEError("sendFailedEvent", itsState.stateName());
    }
}
```

Listing 12-46 (Continued)
ServerController.java

```

public void goodCompileEvent() {
    FSMError("goodCompileEvent", itsState.stateName());
}

public void validUserEvent() {
    FSMError("validUserEvent", itsState.stateName());
}

}

//-----
//
// class LoggedIn
//   handles the LoggedIn State and its events
//
private class LoggedIn extends State {
    public String stateName() {
        return "LoggedIn";
    }

    //
    // responds to abortEvent event
    //
    public void abortEvent() {
        reportError();

        // change the state
        itsState = itsIdleState;
    }

    //
    // responds to compileEvent event
    //
    public void compileEvent() {
        // change the state
        itsState = itsCompilingState;

        // Entry functions for: Compiling
        doCompile();
    }
}

//-----
//
// class StoringUser
//   handles the StoringUser State and its events
//
private class StoringUser extends State {
    public String stateName() {
        return "StoringUser";
    }
}

//
// responds to userNotStoredEvent event

```

Listing 12-46 (Continued)
ServerController.java

```

//
public void userNotStoredEvent() {
    denyRegistration();

    // change the state
    itsState = itsIdleState;
}

//
// responds to userStoredEvent event
//
public void userStoredEvent() {
    confirmRegistration();

    // change the state
    itsState = itsIdleState;
}

//
// responds to abortEvent event
//
public void abortEvent() {
    reportError();
    denyRegistration();

    // change the state
    itsState = itsIdleState;
}

//
// responds to sendFailedEvent event
//
public void sendFailedEvent() {
    denyRegistration();

    // change the state
    itsState = itsIdleState;
}
}

//-----
//
// class Idle
//   handles the Idle State and its events
//
private class Idle extends State {
    public String stateName() {
        return "Idle";
    }
}

//
// responds to abortEvent event
//
public void abortEvent() {
    reportError();

```

Listing 12-46 (Continued)
ServerController.java

```
}

//
// responds to registerEvent event
//
public void registerEvent() {
    // change the state
    itsState = itsStoringUserState;

    // Entry functions for: StoringUser
    storeUserAndSendPassword();
}

//
// responds to compileEvent event
//
public void compileEvent() {
    sendCompileRejection();

    // change the state
    itsState = itsIdleState;
}

//
// responds to loginEvent event
//
public void loginEvent() {
    // change the state
    itsState = itsLoggingInState;

    // Entry functions for: LoggingIn
    checkValidUser();
}

//-----
//
// class Closing
// handles the Closing State and its events
//
private class Closing extends State {
    public String stateName() {
        return "Closing";
    }
}

//
// responds to closeEvent event
//
public void closeEvent() {
    // change the state
    itsState = itsClosedState;
}

//-----
```

Listing 12-46 (Continued)
ServerController.java

```
//  
// class Compiling  
//   handles the Compiling State and its events  
//  
private class Compiling extends State {  
    public String stateName() {  
        return "Compiling";  
    }  
  
    //  
    // responds to abortEvent event  
    //  
    public void abortEvent() {  
        reportError();  
  
        // change the state  
        itsState = itsIdleState;  
    }  
  
    //  
    // responds to goodCompileEvent event  
    //  
    public void goodCompileEvent() {  
        sendCompileResults();  
  
        // change the state  
        itsState = itsClosingState;  
  
        // Entry functions for: Closing  
        close();  
    }  
  
    //  
    // responds to badCompileEvent event  
    //  
    public void badCompileEvent() {  
        sendCompileError();  
  
        // change the state  
        itsState = itsClosingState;  
  
        // Entry functions for: Closing  
        close();  
    }  
}  
  
//-----  
//  
// class LoggingIn  
//   handles the LoggingIn State and its events  
//  
private class LoggingIn extends State {  
    public String stateName() {  
        return "LoggingIn";  
    }  
}
```

Listing 12-46 (Continued)
ServerController.java

```
//
// responds to abortEvent event
//
public void abortEvent() {
    reportError();

    // change the state
    itsState = itsIdleState;
}

//
// responds to validUserEvent event
//
public void validUserEvent() {
    acknowledgeLogin();

    // change the state
    itsState = itsLoggedInState;
}

//
// responds to invalidUserEvent event
//
public void invalidUserEvent() {
    rejectLogin();

    // change the state
    itsState = itsIdleState;
}

//-----
//
// class Closed
//   handles the Closed State and its events
//
private class Closed extends State {
    public String stateName() {
        return "Closed";
    }
}
}
```

Bibliography

[PEAA2002]: *Patterns of Enterprise Application Architecture*, Martin Fowler, Addison Wesley, 2002

[GOF95]: *Design Patterns*, Gamma, et. al., Addison Wesley, 1995

[TDD2002]: *Test Driven Development*, Kent Beck, Addison Wesley, 2002.

[PPP2002]: *Agile Software Development: Principles, Patterns, and Practices*, Robert C. Martin, Prentice Hall, 2002.

[PLOP95]: *Pattern Languages of Program Design*, Volume I, Coplien and Schmidt, Addison Wesley, 1995

