

NEW AGE

# BASIC ENVIRONMENTAL ENGINEERING



**R.C. Gaur**



NEW AGE INTERNATIONAL PUBLISHERS

**BASIC  
ENVIRONMENTAL  
ENGINEERING**

**This page  
intentionally left  
blank**

# **BASIC ENVIRONMENTAL ENGINEERING**

**R.C. Gaur**

B.E. Civil, M.E. Civil (Envrn.), Ph.D. (I.I.T., Delhi)

*Professor*

Civil Engineering Department  
University College of Engineering  
Rajasthan Technical University  
Kota



PUBLISHING FOR ONE WORLD

**NEW AGE INTERNATIONAL, (P) LIMITED, PUBLISHERS**

New Delhi • Bangalore • Chennai • Cochin • Guwahati • Hyderabad  
Jalandhar • Kolkata • Lucknow • Mumbai • Ranchi

Visit us at [www.newagepublishers.com](http://www.newagepublishers.com)

Copyright © 2008, New Age International (P) Ltd., Publishers  
Published by New Age International (P) Ltd., Publishers

---

All rights reserved.

No part of this ebook may be reproduced in any form, by photostat, microfilm, xerography, or any other means, or incorporated into any information retrieval system, electronic or mechanical, without the written permission of the publisher.  
*All inquiries should be emailed to [rights@newagepublishers.com](mailto:rights@newagepublishers.com)*

**ISBN (13) : 978-81-224-2701-1**

**PUBLISHING FOR ONE WORLD**

**NEW AGE INTERNATIONAL (P) LIMITED, PUBLISHERS**

4835/24, Ansari Road, Daryaganj, New Delhi - 110002

Visit us at [www.newagepublishers.com](http://www.newagepublishers.com)

**Dedicated to the Memories of**

My Beloved Brother Rajoo  
&  
Sister Mrs. Lata Sharma.

**This page  
intentionally left  
blank**

# PREFACE

---

Environmental engineering is one of the most popular, complex and fast growing disciplines in engineering. The scope of environment includes issues from public health, aesthetics, and impact of all development activities, pollution control legislation, standards, regulations, guidelines and their enforcement. Traditionally the application of engineering principles for the protection and enhancement of the quality of environment and protection of public health was called as sanitary engineering or public health engineering. Around 1968 this was changed to environmental engineering.

For conceiving environmental engineering, one has to consider the definition of engineering itself. Engineering may be defined as the application, under limits of scientific principles for the planning, design, execution, operation and maintenance of structures, equipment and systems for the development and benefit of the society. Here the word benefit is more important than the development. The so-called development in some cases may not be in real benefit of the society.

The environmental engineer plans, designs, executes, operates and maintains the water, wastewater and solid waste management plants. Clean, bacteriologically safe, potable drinking water protects and enhances public health. Liquid and solid waste management is a necessary step for healthy living. They also deal with air pollution control. The resulting pure cleaner air is conducive to people's good health and prevents the building and other materials from the harmful effects of air pollution. The environmental engineer cares for the energy requirements of the society and the ways and means to protect the environment against the various pollutions created through the production and consumption of various goods and comfort conditions. It is the duty of environment engineer to assess the environmental impacts of the various development and other activities. In general one has to work to have sustainable and holistic development. Of course there are always constraints of resources, knowledge, human nature, social and racial considerations that limit the achievement of these goals.

Therefore the environmental engineering is defined as the application of scientific and engineering principles, under limits, for the protection and enhancement of the environment that includes the biotic and abiotic both components.

The environment exists in dynamic equilibrium of its biotic (living) and abiotic (non-living) elements. The solar energy induced photosynthesis synthesizes the carbon as the plant tissue and we get matter in various forms from the trees. The carnivores, humans and animals consume the edible matter. They convert it into the energy required to sustain their lives. Their excreta comes near to the nature and the natural scavengers, bacteria and others convert it into inorganic matter like nutrients due to the biological decomposition. The roots of the plants, to form the edible matter again, extract these nutrients. Like this the nutrient cycle, material cycle, energy cycle and other cycles like hydrological cycle keep on existing until there is a great shock given by the human beings.



**(viii)**

“Nature has enough for satisfying everybody’s need but not for anybody’s greed”. Human beings have lost their natural wisdom in want of power to overcome the nature. Since mid century the world has lost nearly one fifth of the topsoil from its cropland, a fifth of its tropical rainforests and animal species. Rapid industrialization and urbanization has increased carbon dioxide levels to the point where global climate is being affected. The protective ozone shield is being depleted because of the chlorofluorocarbons. The forest, which is a complete ecosystem, is being converted into dead forests. The biodiversity is reducing everywhere in the world.

Biodiversity gives strength to the ecosystem against crisis. Only a well-diversified community can sustain against the extreme conditions. In quest of comfort conditions and well-secured life we have adopted a system, which is completely away from nature. We have made computers for paper less office work but the energy in making and running the computers is more than the savings made. Of course there are other advantages of computers in computation, up keeping of data etc. But the materials used in making the computer and the disposal of the obsolete ones are drastically against the environment.

The quest of more and more comfort has fetched us far away from natural environment. The input of energy in building sector is increasing day by day. The requirements of both heating and cooling are becoming more and more energy exhaustive. At present the energy requirement in whole world is mainly met by fossil fuels. Nature has created the coal and petroleum in millions of years and we have exhausted them in hundreds of years. In the last 300 years we have consumed most of the coal and almost all of the petroleum products.

Out of the 1,30,000 MW installed capacity of electricity production in India about 66% is by fossil fuels (coal+ petroleum products), 24% by hydropower, 4% by nuclear means and only 6% by renewable energy resources like solar, wind, biomass including small hydropower plants. Still there is a very large potential of renewable energy resources unutilized but the present availability of fossil fuels and the present high cost of electricity production through R.E.S. has restrained their share to only 6%. With the advancement of technology and scarcity of fossil fuels the cost of RES will come down and their share shall increase, but is it the sustainable development? In modern context the idea of sustainable development emerged in the Earth Summit at Rio-De-Janeiro in June 1992 that let us plan a development in which the generations to come, may not become deprived of the resources which we are using today. To achieve this aim we have to control our present rate of consumption of the available resources like the fossil fuels, ground water and conserve the bio diversity and the natural cycles like the hydrological cycle.

While considering the production, consumption or utilization we have also to consider the other part that is pollution. Mixing of unwanted hazardous elements in anything is known as pollution, like mixing of sewage in fresh body of water, mixing of gases, like oxides of nitrogen, oxides of sulphur etc. in the air, increase of noise level etc. Actually the present trend of living is a serious cause of creating pollution in all spheres of life. Today the prosperity, wealth or living standard of a country is measured in terms of the per capita electricity consumption per year. That way India with its per capita consumption of 350 Kwh per year is considered far behind the U.S. which has around 20 times more than this. The advancement of a society is measured in terms of the measures of comfort like air conditioners, or conveyance like bigger and bigger expensive luxury cars. Taller buildings, more and more precious artificial fabric and so on. Production and maintenance of all these has created so much land, water and noise pollution that has overcome the advantages of all these so called advancements. Thus the challenging aspect of environmental engineering is to make balance between the rapid changes in the field of science, technology, health etc. and the very existence

of life. Though environmentalism or the environmental consciousness is ancient the environmentalism became an organized force only in 1960s. It started with the publication of the book *Silent Spring* by Rachel Carson on the pesticide DDT in 1962. Actually the exponential growth of population and the worldwide consumerism imposed a great load on earth's natural resources and waste management systems.

This text aims at the fundamental, primary knowledge for every one who has a concern about environment. The chapters have been designed to quench the thirst of knowledge of a person, let it be a scientist, an engineer or any one who is concerned about protection of environment and thus a well wisher of society.

This book has been written after gaining 10 years experience of working in the public health engineering department of Rajasthan and 20 years experience of teaching civil engineering students, subjects like environmental engineering, ecology and environmental dynamics, solid waste management etc. Recently environmental engineering has been introduced as a primary course common to **first year students of all branches** who opt for it. This text is on basic environmental engineering that covers the syllabus of first year semester scheme of the Rajasthan Technical University and other universities. Some portion of the material presented in this book has been derived from the work of others, their contribution is greatly acknowledged. The recommendation of manual of water supply and treatment, manual on Sewerage and Sewage Treatment and manual on Solid Waste Management prepared by the Central public Health and Environmental Engineering organization, Government of India, Ministry of urban development have been closely followed.

I acknowledge my debts to my parents for their blessings, my wife Bharati for her constant support, my daughter Ruchira for her help on computer, my son Saurabh and daughter-in law Surabhi for encouragement.

I express my deep sense of gratitude to my teacher Prof. Damodar Sharma, Vice chancellor Rajasthan Technical University, Kota for being a constant source of inspiration for me.

I thank Prof. M. P. Poonia Principal Engineering College Bikaner for his valuable suggestions. I thank Dr. A. K. Mathur and other colleagues of my department for their help. I thank Mr. S. Gupta, Managing Director, New Age International Publishers, New Delhi for prompt publication.

**R. C. GAUR**

**This page  
intentionally left  
blank**

# CONTENTS

---

<i>Preface</i>	<i>(vii)</i>
<b>1. GENERAL CONSIDERATIONS</b>	<b>1</b>
1.1 Basic Concepts	1
1.2 Biotic and Abiotic Environment	2
1.3 Adverse Effects of Environmental Pollution	2
1.4 Control Strategies	4
1.5 Environmental Act and Regulations	6
1.5.1 International Concern for Environment	7
1.5.2 Environmental Protection laws in India	7
1.6 Regulatory Structure of Pollution Control Authorities and their Functions	9
1.6.1 Functions of M.O.E.F	9
1.6.2 Functions of the Central Pollution Control Board	9
1.6.3 Functions of the State Pollution Control Board	10
1.7 Conclusion	11
<b>2. WATER POLLUTION</b>	<b>13</b>
2.1 Introduction	13
2.2 Water Resources	13
2.2.1 Rainfall	14
2.2.2 Distribution of Rainfall	15
2.2.3 Measurement of Rainfall	15
2.3 Surface Sources of Water Supply	17
2.4 Subsurface or Underground Sources	21
2.4.1 Porosity	21
2.4.2 Permeability	21
2.5 Ground Water Yield	22
2.5.1 Drilling of Tube-Wells	23
2.5.2 Lowering of Pipes and Gravel Packing	26
2.5.3 Development of Tube-Wells	26
2.5.4 Yield of a Tube-Well	27
2.5.4.1 Yield of a Tube-Well in an Unconfined Aquifer	27
2.5.4.2 Yield of a Tube-Well in a Confined Aquifer	30
2.6 Basics of the Water Supply Schemes	32
2.6.1 Quality of Water	35

2.6.2 Characteristics of Water	38
2.7 Treatment of Water	42
2.7.1 Screening	42
2.7.2 Plain Sedimentation	42
2.7.3 Sedimentation Aided with Coagulation	43
2.7.3 Filtration	43
2.7.4 Disinfection	44
2.7.5 Aeration	45
2.7.6 Water Softening	46
2.8 Requirement of Pressure of Water to be Supplied	48
2.9. Waste Water Management	49
2.9.1 Prevention of Pollution	49
2.9.2 Statutory Water and Sanitation Boards	50
2.9.3 Waste Water Management	51
2.9.3.1 Collection of Domestic Wastewater	51
2.9.3.2 Conveyance or Transportation of Waste Water	52
2.9.3.3 Design of the Sewer Line	52
2.9.3.4 Hydraulics of Sewers	54
2.9.1 Treatment of Wastewater	55
2.9.1.1 Unit Operations and Processes	57
2.9.1.2 Methods of Treatment of Wastewater	59
2.9.5 Anaerobic Digestion	60
2.9.6 Disposal of Treated Wastewater (Effluent)	61
2.9.7 Disposal into Water Bodies	62
2.9.7.1 Disposal on Land	63
2.9.8 Onsite Sanitation	64
2.9.9 Septic Tank	64
2.9.10 Soak Pits	65
2.10 In-house Treatment and Saving of Water	66
2.11 Conclusion	
<b>3. AIR POLLUTION</b>	<b>69</b>
3.1 Introduction	69
3.2 Formal Definition of Air Pollution	70
3.3 Classification of Pollutants	71
3.3.1 Classification of Air Pollutants	71
3.3.2. Primary and Secondary Air Pollutants	73
3.4 Classification based on Position	74
3.5 Harmful Effects of Air Pollution on Materials	76
3.6 Control of Air Pollution	77
3.7 Control of Automobile Pollution	78
3.7.1 Catalytic Converter	78
3.8 Noise Pollution	79
3.9 Greenhouse Effect & Global Warming	79
3.10 Acid Rain	80
3.11 Ozone Depletion	82
3.11.1 Causes of the Ozone Layer Depletion	82
3.11.2 Effects of Ozone Layer Depletion	83

**(xiii)**

3.11.3 Preventive Action to Ozone Depletion	83
3.12 Conclusion	83
<b>4. SOLID WASTE MANAGEMENT</b>	<b>87</b>
4.1 Introduction	87
4.2 Classification of Solid Waste	89
4.2.1 Importance of Classification	91
4.3 Composition and Characteristics of Solid Waste	93
4.3.1 Characteristics of Municipal Solid Waste in Indian Cities	93
4.4 Expected Quantities of Solid Waste	95
4.5 Physical Characteristics	96
4.6 Chemical Characteristics	97
4.7 Waste Management Approach	98
4.7.1 Inventory Management and Improved Operation	98
4.7.2 Utilization of Waste	99
4.8 Solid Waste Management: An Overview	100
4.8.1 Identification of Waste and its Minimization at the Source	100
4.8.2 Collection, Segregation and Storage at the Site of Collection	101
4.8.3 Transportation of Solid Waste	102
4.8.4 Treatment of Solid Waste	102
4.8.5 Energy Recovery and Disposal	103
4.8.5.1 Incineration	103
4.8.5.2 Landfill	104
4.8.5.3 Composting	105
4.9 Energy Recovery from Municipal Solid Waste	106
4.8.1 Parameters Affecting Energy Recovery	107
4.10 Sanitary Landfill	108
4.11 Hazardous Waste Management	109
4.12 Bio-Medical Waste	110
4.13 Conclusion	111
<b>5. ECOLOGY</b>	<b>115</b>
5.1 Introduction	115
5.1.1 Objectives of Ecological Study	117
5.1.2 Useful Definitions	117
5.1.3 Classification of Various Aspects of Ecology	119
5.1.3.1 Autecology	119
5.1.3.2 Synecology	120
5.1.3.3 Classification on the Basis of Habitat	120
5.1.3.3.1 Modern Sub-Divisions of Ecology	120
5.1.4 Functional Concepts of Ecology	121
5.2 Basics of Species	122
5.3 Ecosystem	122
5.3.1 Cyclic Operation of Ecosystems	124
5.3.1.1 Geophysical	124
5.3.1.2 Hydrological Cycle	125

5.3.1.3 Chemical Cycle	128
5.3.2 Ecosystem and Human Beings	130
5.3.3 Biome and Ecosystem	131
5.4 Energy Flow in the Ecosystem	132
5.4.1 Solar Energy	133
5.5 Major Ecosystems of the World	135
5.5.1 Sea as an Ecosystem	136
5.5.2 Estuaries	136
5.5.3 Streams and Rivers	136
5.5.4 Lakes and Ponds	137
5.5.5 The Terrestrial Formations	137
5.5.6 Deserts	137
5.5.7 Tundras	138
5.5.8 Grasslands	138
5.5.9 Forest	139
5.6 Biodiversity	140
5.6.1 Basic Laws of Biodiversity	141
5.7 Population Analysis	<b>142</b>
5.7.1 Population Characteristics	142
5.7.2 Regulation of Population	143
5.7.3 Population Dynamics	143
5.8 Conclusion	146
<b>6. RENEWABLE SOURCES OF ENERGY</b>	<b>149</b>
6.1 Introduction	149
6.2 Renewable Sources of Energy	151
6.2.1 Solar Energy	151
6.2.2 Wind Energy	153
6.2.3 Energy from Water	155
6.2.4 Energy from Oceans	156
6.2.5 Energy from Biomass	156
6.2.6 Geothermal Energy	156
6.3 Potential of Renewable Energy Resources in India	157
6.4 Conclusion	<b>158</b>
<b>7. ENVIRONMENTAL IMPACT ASSESSMENT</b>	<b>161</b>
7.1 Introduction	161
7.2 Necessity of Environmental Impact Assessment	163
7.3 Methodology of Environmental Impact Assessment	164
7.3.1 Identification of Impact Areas	164
7.3.1.1 Water Resource Project	164
7.3.1.2 Hydroelectricity Project	172
7.3.1.3 Navigation Project	172
7.3.1.4 Tidal Hydro Electricity Project	172
7.3.1.5 Wave Energy Generation	173
7.3.1.6 Wind Energy Project	173
7.3.1.7 Geothermal Energy	174

7.3.1.8 Solar Energy	174
7.3.1.9 Thermal Power Plants	174
7.3.1.10 Biomass or Biogas Power Plant	175
7.3.1.11 Industries	<b>175</b>
7.3.2 Data Collection	176
7.3.3 Prediction	177
7.3.4 Assessment	179
7.4 Conclusion	180
<b>8. NOISE POLLUTION</b>	<b>183</b>
8.1 Introduction	183
8.2 Levels of Noise	184
8.3 The Nature of Sound	184
8.3.1 Amplitude(A)	185
8.3.2 Pitch	185
8.3.3 Power and Intensity	186
8.4 Sensitivity of Sound	186
8.5 Levels of Noise and its Measurement:	187
8.6 Acceptable Noise Levels	188
8.7 Effects of Noise	189
8.8 Adverse Effects of Noise	190
8.8.1 Effects on Human Body Function	190
8.8.2 Sleep Interference	190
8.8.3 Effect on Working Efficiency	190
8.8.4 Effect on Wild Life	190
8.8.5 Effects on Non Living Things	190
8.9 Control of Noise Pollution	191
8.9.1 Noise Control at Source	191
8.9.2 Noise Control along the Path	191
8.10 Noise Control at Receiving End	191
8.11 Other Ways of Noise Control	191
8.12 Measurement of Noise	192
8.13 Conclusion	192
<b>Bibliography</b>	<b>195</b>
<b>Index</b>	<b>199</b>



**This page  
intentionally left  
blank**

# GENERAL CONSIDERATIONS

---

## 1.1 BASIC CONCEPTS

The whole universe exists since an unknown time with unknown origin and creator. As it can be sensed by the trivial physical and mental powers of humans there is always a reason and a force behind any act, process, creation and destruction. There must be some logical reason behind the creation of this world. Since the beginning of civilizations human beings are in quest of this eternal knowledge but could not come to any conclusion. The ancient Indian thinkers after great deliberations concluded that “Neti...Neti... This is neither this nor that”. It is still difficult to analyze the real fact or the absolute truth. But it has been well established that whosoever has created this universe, the solar system, the earth and different planets with whatsoever reason, it is, with us with all its known and unknown colours. We may not still know about many of its aspects as we have limited knowledge and senses to observe it. It may have more dimensions than that are known to us. But it is sure that we are making harm to it and destroying it in real sense.

As per the Indian mythology we have come as human beings after taking birth in 84 lac different species, where as the modern science has established them to be more than 30 million species of plants and animals. But none of the other known species has harmed this beautiful planet as much as the human beings, claiming themselves as the wisest ones.

This is the cause of concern that with claiming ourselves as the highest order of living beings how can we be so brutal and unwise to destroy our own self like Bhasmasur? We have to think deeply and act accordingly to stop this fatal destruction. Having an intelligent approach for the solution of this universal problem one has to think in a global and holistic manner.

## 1.2 BIOTIC AND ABIOTIC ENVIRONMENT

In general the surroundings of an organism living in its natural habitat is termed as environment. These surroundings include all; physical, mental and spiritual conditions. The human beings are so complex in nature that it is a combined effect of every thing, which exists, far or near them, affects their life (mental, physical and spiritual). The gravitational forces of distant planets affect each other and these movement or rotation is based on the balance between them. Tides come because of the gravitational attraction of moon and sun, which move the bodies of water on the earth as well as the water, which is the main constituent of human body (75%). It has been well established that the non-living things and the living beings are totally interrelated and dependent on each other. It is only a matter of time that something is nonliving or somebody is living being. We consume the food, which becomes part of our body cells and gets changed into living being. After the death of those cells or the whole body it again becomes non-living. So it is a combination or synthesis of various elements with some unknown factor like soul that demarcates the living beings and non-living things. But it is sure that nature is in dynamic equilibrium of both of them. Thus we can classify the environment as

### 1.2.1 Physical or abiotic environment

It consists of physical factors Land (minerals, toxic elements, nutrients), sky (sink of various things, noise) and air (useful and other gases). Anciently, we have realized this combination as “ Ksiti (Earth), Jal (Water), Pavak (Fire), Gagan (Sky), Sameera (Air): the five basic elements (Panch Tatva) which influence life.

### 1.2.2 Living or biotic environment

It consists of plants, animals (including human beings) and micro-organisms. Life in the form of micro-organisms is very strange and subtle (strong). Fungus is available upto 3 Kms. Below the earth. Thus the earth is not made for human beings alone.

All these constituents of environment are referred to as the environmental factors or an ecological factor, which is defined as an ecological condition, which directly or indirectly affects the life of an organism. These biotic and abiotic components are in a dynamic state i.e. they constantly depend and affect each other and cannot be dealt in isolation with each other. **This is the fundamental of Environmental Science or Engineering.**

Wherever we have not considered this interdependence and interrelation, knowingly or unknowingly, we have destroyed the very structure of a factor. This unthoughtful use of a resource, dealt in isolation, pollutes the other environmental factor, which in turn affects the polluting one, as all of them are interrelated and interdependent. **This is the fundamental of environmental pollution.**

## 1.3 ADVERSE EFFECTS OF ENVIRONMENTAL POLLUTION

In the nature the niche (role to play) of its every element is fixed; means the role which it has to play is pre-decided and prefixed, be it living or non-living. Every operation is

cyclic and each and every link of this cycle is important and indispensable. For example in the hydrological cycle the water gets evaporated from the sea and over the other parts of the earth depending upon the climatic factors; mainly the temperature and the relative humidity. The wind transport it all over the earth and the condensation supplies fresh, sweet water to all places where it is required for supporting life. It goes down the earth by infiltration and percolation. Again it comes to the atmosphere through the leaves of trees and evaporation from the exposed surfaces of water i.e. evapotranspiration. The underground water emerges as springs or extracted by human beings as wells etc. Here comes the human intervention. Because of the ever-increasing demands of the agriculture (population increase) we have exploited the ground water to such a level that most of the regions have become dark zones. Then to fulfill our ever increasing energy demands in quest of the so called comfort conditions we have burnt such a large amount of fossil fuels that has increased the CO<sub>2</sub> level (from 300 to 350 p.p.m) in the last century.

Actually, glass has the property to allow the short-wave radiation of sun through it and prevent the long wave heat radiation to pass through it. In cold climatic countries houses made up of glass are used to take advantage of this phenomenon i.e. the entry of solar radiation and entrapping the long wave heat radiation inside it. Like this if the outside temperature is -25°C the inside temperature can be raised to 25°C, for example. Greenery can be easily grown at this suitable temperature and that is why it is known as the green house effect. CO<sub>2</sub> works similar to the glass i.e. it allows the short-wave solar radiation, but prevents the long wave heat radiation, radiated from the earth to the far sky. This helps in maintaining the earth warm, but the increasing concentration of CO<sub>2</sub> is increasing the earth's mean global annual temperature. It was around 14.5°C in the last century but now it is increasing at a rate of 1°C per century. This is known as the global warming and is causing imbalance in the rainfall over the globe. It is also increasing melting of snow on the glaciers and raising the level of sea, endangering the existence of cities near the seas like Mumbai or countries like Mauritius. This is one example of effect of pollution in which increased concentration of CO<sub>2</sub> generated due to human activities (industrialization, Urbanization) resulted in increase of temperature. So the human activity like burning of fossil fuels is imposing this adverse effect of increasing temperature, on environment.

Alongwith this, the increased concentration of other gases like oxides of Nitrogen and Sulphur (NO<sub>x</sub> and SO<sub>x</sub>), the increased suspended particulate matter (S.P.M) are also causing so many diseases and the problems like acid rain etc. which shall be discussed in the chapter of Air Pollution. The Chlorofluorocarbons used in air conditioning are depleting the useful ozone layer in the stratosphere. The ozone prevents the ultra violet portion of the solar radiation and this reduction in the concentration of ozone, popularly known as ozone hole results in skin cancer. Against human's foul plays, nature has much shock proofing arrangements and rectifying measures. But they have their limits and if the limits are crossed then the natural disasters like tsunami and Al-Nino etc. take place.

### **1.4 CONTROL STRATEGIES**

After having the primary knowledge of environment, that it is the surroundings that influence the development and growth of mankind and it covers all important facts of our life like physical, chemical, biological, social, economical and spiritual: having knowledge of pollution and its adverse effects; one has to seriously think about environmental protection. Time has gone when the earth was feeding us, protecting us as the Mother Earth. In the last century we have lost 60% of the forest cover. Forests are the assets of our Mother Earth. A forest is a complete ecosystem i.e., sustainable in itself. Its main part is trees and other vegetation. Trees provide us the fruits, fodder, timber, paper, gum, herbs, medicines, firewood and so many other products. They release oxygen and consume the CO<sub>2</sub> (responsible for global warming). As a recent estimate one hectare of forest consumes 3 tons of CO<sub>2</sub> and produces 2 tons of O<sub>2</sub> per year approximately. They pump the subsoil water into the atmosphere through transpiration and increase the relative humidity in air, which leads to rainfall. They purify the air by absorbing the gases like SO<sub>x</sub> and NO<sub>x</sub> and the particulate matter. This way they act like Lord Shiva who consumed the poison produced from the sea when it was explored. This created a sore in his throat and he was called as "Neel-Kantha". Trees play the same role i.e. they absorb the harmful gases and the particulate matter and their leaves become sick (blisters). That is why we worship the trees. Trees prevent the soil and water erosion by the confining effect of their roots. They reduce the velocity of wind thus reduce the movement of sand and the expansion of deserts. The canopy of trees detains the raindrops and thus delays the run-off causing floods. They also reduce the velocity of floodwaters and the consequent destruction. Trees absorb the sound waves and thus reduce the noise pollution. They provide shelter to the birds and other animals as a natural habitat. They provide shade to the buildings and earth and thus reduce the ambient and surface temperatures. The greenery provided by them reduces the atmospheric glare and soothes our eyes and gives us a psychological effect of protection and prosperity. Trees make the forest a complete ecosystem. The ecosystem conserves the biodiversity and the biodiversity protects the Mother Earth. If earth has enough variety and amount of belongings in its bosom, then only it can distribute them as mother. Time has come when the mother has lost its forest cover, its underground water, its fertile cover of soil (humus). Everything which nature has created in millions of years humans have snatched, consumed, exhausted or destroyed in hundreds of years.

In these conditions are we lesser wiser than our ancestors? They prayed to the God for the peace and harmony to water, sky, soil trees and herbs, natural powers intellectuals and the whole universe in the "Shanti Mantra". Can't we control the environmental degradation by striking to the root cause of it? The root cause is the ever-increasing demands and resulting exploitation of the nature. The demand is increasing firstly due to the increasing human population and secondly the increasing level of consumption of resources without thinking about their limited availability and the destruction produced by the adopted processes of utilization and faulty disposal methods of waste produced.

So first of all we have to control the increase of human population, wisely. No prosecution or law can forcibly control the population. It should be controlled through the education and setting of examples by the thinkers and leaders of the society followed by the masses. Incentives should be given to the persons contributing to the birth control programmers. To have a larger group of persons of same interest it was wiser to increase the human population in the beginning of the civilization. The harsh conditions of nature, fear of unknown wild powers led to bigger and bigger groups. But the time has changed now science has given us powerful tools. So a wise, bold and modern society can uproot this feeling and control its population by itself.

The second control strategy is the reduction in consumption of the limited resources. Fresh water is only 0.1% of the total water on the earth and if we misuse it and convert it into waste water to be again mixed in the fresh body of water (river) it is not less than a sin. Using water of a quality in a work where inferior quality water could have been used is also an unwise act. The present sanitation system in which one part of human excreta is carried away by 99 parts of potable (drinking) water is not a wise option. Sanitation and cleanliness is a must but it should be obtained in an overall wise manner. Actually the soil has soil bacteria, which can easily decompose the waste organic matter (biodegradable) without deteriorating the environment and can convert it to useful manure. Water also has aerobic bacteria for the decomposition of the same organic matter but these bacteria consumes the oxygen, which is present in the fresh body of water as dissolved oxygen. The depletion of this D.O. causes all types of problems like the damage to the aquatic life and the development of foul conditions to the fresh body of water, which requires more and more treatment of raw water to make it potable. After spending a lot of money (Resources, energy) we make it fit for drinking and then use it for all purposes like flushing and gardening. Only 5-10 liters of water is required per person per day for drinking/cooking; that is oral consumption but we are using 200 liters pure, bacteria free potable water, which is costing not less than 15 Rs. per thousand litre. Here the main concern is about the wasteful expenditure and the consequent pollution caused due to the disposal of sewage/wastewater into the rivers and other streams. This type of sanitation system needs an immediate change. Some N.G.O. at MGIRI (Mahatma Gandhi Institute of Rural Industrialization) at Wardha near Nagpur has invented an Indian type W.C. Pan in which only one litre of water is sufficient for flushing the human excreta in one operation. That small amount of water + excreta goes inside the earth and there is no requirement of sewer line, treatment and disposal of sewage. Another N.G.O in Nagpur has demonstrated the commercially viable conversion of human excreta into biogas and its utilization within the same premises. This is a two fold solution that the amount of waste is reduced and its consumption reduces the subsequent pollution. Sometimes the solution may not be easy as the subsoil may not be porous and sewerage system may be a must, but in that case also the nonfoul wastewater from kitchens and bathrooms can be reused in flushing and gardening without any problem. This can reduce the consumption of treated potable water by 40% and reduce the quantity of sewage also.

The other main important point of consideration is use of fossil fuels for production of electricity, and transportation etc. Coal, petroleum and gas all are limited and exhaustible in nature. We have consumed most of them and in coming century we will not find any petroleum. Alongwith the scarcity the main problem of concern is the environmental pollution. They produce harmful gases like oxides of sulphur (SO<sub>x</sub>) and oxides of Nitrogen (NO<sub>x</sub>), unburnt hydrocarbon, CO and suspended particulate matter etc. This is the major manmade cause of air pollution. The flyash (residual of coal burning) is another hazard. In place of these fossil fuels renewable sources of energy like sun, wind, biomass and hydropower can be beneficially used. The presently available technology is not sufficient as the cost of electricity production by renewable is higher than the thermal means except for the hydropower which is available at limited places only.

Sun is the ultimate source of energy and its radiations are freely available at all places. There is a necessity of harnessing the solar energy directly or after converting it into electricity. The present technologies like photo-voltaic conversion are not fully environment friendly as the manufacturing of PV cells itself is too much energy intensive. The solar thermal route is a better option, which can be further improved. The harnessing of wind power, tidal power are very good options. India is the only country having separate ministry of non-conventional energy resources, emerging as a prominent power in the field of electricity generation with wind power (6300 MW). Still there is a need of optimum utilization of these resources, which are comparatively more eco friendly as producing lesser pollution.

## 1.5 ENVIRONMENTAL ACTS AND REGULATIONS

**Various Acts and regulations:** - After knowing something about the various elements of environment, their dynamic interrelationship and the adverse effects of environmental pollution, one should work in the direction of adopting the pollution control strategies. For this, provision of Acts and regulations is a must in the present setup of the society. In the ancient system the environmental management was a part of life when consideration of animals like cows, dogs, cats etc., birds like sparrows, flamingo (KURAJA) peacocks etc. was there in daytoday life and they were treated as part of family. A small share of meals was contributed by every person/family and a voluntary adjustment existed in the Indian society structure. Trees and shrubs like Neem, Peepal and Banyan, Tulsi etc. were worshiped like Gods and rivers were praised like Mother Goddesses. Sun was considered to be the prime source of energy and happiness and the daily routine was so adjusted to cater more and more energy through its radiations and using least amount of other means, like the valuable natural resources, coal, petroleum etc. Human and animal energy was used for transportation and the buildings were designed for natural daylighting, natural ventilation and least heating/cooling demands. This prevented the environment from being polluted but the present trend of living in nucleus families with self-centeredness, living away from nature, desire of more and more comforts has led the society to such an extent of consumerism that there is no



scope of environment protection. In this era it can be obtained only by imposing rules, regulations, acts, penalties and such other measures. There are so many regulations to be fulfilled by the individuals, entrepreneurs, industrialists, producers, consumers, society, nations and internationals.

### **1.5.1 International Concern for Environment**

The international concern for environment was first immersed in the United Nations Conference on Human Environment in Stockholm in June 1972 where a declaration was made that

- (i) Man has the fundamental right to freedom, equality and adequate conditions of life in an environment of quality that permits a life of dignity and well being.
- (ii) Man bears a solemn responsibility to protect and improve the environment for present and future generations.

This declaration was adopted by the United Nations General Assembly in December 1972 and June 5 was declared as the World Environment Day.

The conference on Security and Co-operation in Europe on August 1, 1975, announced that "Environmental protection was important both for the well being of the people and economic progress of the country".

An international conference on environmental education was held at New Delhi in Dec. 1982 stressing the need of formal and informal environmental education right from childhood.

### **1.5.2 Environmental Protection Laws in India**

Our country's concern for environment is evident from the fact that the constitution of India makes provisions for environmental protection in the chapters on:

- (i) Fundamental Rights
- (ii) Directive Principles of State Policy
- (iii) Fundamental Duties

Article 47 of the constitution (1950) states that

"State shall regard the raising of the level of nutrition and the standard of living of its people and improvement of public health as among its primary duties...."

The Indian constitution was amended in the year 1976 and article 48-A was added which states that

"The state shall endeavor to protect and improve the environment and to safeguard the forest and wildlife of the country". The same amendment was added as a fundamental duty to be observed by every citizen in article 51-A (g):

"To protect and improve the natural environment including forest, lakes, rivers and wildlife and to have compassion for living creatures."



In 1974, the Parliament enacted the water (Prevention and Control of Pollution) Act, 1974. The Water (Prevention and Control of Pollution) Cess Act was enacted in 1977 and in order to increase the scope of this legislation the Act of 1974 was amended in 1978.

The Air (Prevention and Control of Pollution) Act was enacted in 1981 and the Environment Protection Act was enacted by the parliament in 1986. In 1986, the Government of India established an independent Department of Environment to encourage research and awareness towards the protection of environment. Along with these acts and departments the Government of India has made the following other acts:

**(i) *The Wildlife Protection Act, 1972.***

The objectives of the Wildlife Protection Act, 1972 are the following

- (a) To maintain essential ecological processes and life-supporting systems.
- (b) To preserve the biodiversity
- (c) To ensure a continuous use of species i.e. protection and conservation of wild life.

**(ii) *The Water (Prevention and Control of Pollution) Act, 1974***

The aims and objectives of this act are:

- (a) Prevention and control of water pollution
- (b) Maintaining or restoring the wholesomeness of water
- (c) Establishment of boards of the prevention and control of water pollution.

**(iii) *The Air (Prevention and Control of Pollution) Act, 1981***

The objectives of this act are:

- (a) Prevention, control and abatement of air pollution.
- (b) Maintaining the quality of air
- (c) Establishment of boards for the prevention and control of air pollution.

**(iv) *The Environment (Protection) Act, 1986***

The objectives of this act are:

- (a) Protection and improvement of environment (water, air, land) and
- (b) Prevention of hazards to all living creatures (humans, plants, animals) and property
- (c) Maintenance of harmonious relationship between human beings and their environment.

**(v) *The Motor Vehicles Act, 1988***

The objective of this act is the reduction and control of traffic pollution.

The following table shows the order of Environmental Legislation in India.

**Table 1.1 Chronology of Environmental Legislation in India**

<b>S. No.</b>	<b>Year</b>	<b>Environmental legislation</b>
1	1974	The Water (Prevention and Control of Pollution) Act
2	1975	The Water (Prevention and Control of Pollution) Rules
3	1977	The Water (Prevention and Control of Pollution) Cess Act
4	1978	The Water (Prevention and Control of Pollution) Cess Rules
5	1981	The Air (Prevention and Control of Pollution) Act
6	1982/1983	The Air (Prevention and Control of Pollution) Rules
7	1986	The Environment (Protection) Act
8	1986	The Environment (Protection) Rules
9	1989	The Hazardous Waste (Management and Handling ) Rules
10	1992/1993	Environmental (Protection) Rules-“Environmental Statement”
11	1993	Environmental (Protection) Rules-“Environmental Standard”
12	1994	Environmental (Protection) Rules-“Environmental Clearance”
13	1995	The National Environment Tribunal Act

## **1.6 REGULATORY STRUCTURE OF POLLUTION CONTROL AUTHORITIES AND THEIR FUNCTIONS**

These are the main bodies to control the pollution and enforce the various acts regulations laws etc:

- (i) Ministry of Environment and Forest, Government of India (M.O.E.F.)
- (ii) Central Pollution Control Board
- (iii) State Pollution Control Board

### **1.6.1 Functions of M.O.E.F**

- Environmental Policy Planning and Research
- Implementing legislation and monitor/control pollution
- Environmental clearance for projects
- Promotion of Environmental Education, Training and Awareness
- Forest Conservation, Development and Wildlife Protection
- Bio-Sphere Reserve Programme
- Co-ordination with concerned National and International agencies.

### **1.6.2 Functions of the Central Pollution Control Board**

- To promote cleanliness of streams and wells in different areas of the state

- To advise the central government on matters concerning the prevention and control of water pollution.
- To co-ordinate the actions of the state board and resolve disputes among them.
- To provide technical assistance and guidance to the State Boards to carry out research in prevention and control of water pollution problems.
- To organize training of persons engaged in pollution control.
- To organize comprehensive programme for pollution control through mass media.
- To lay down standards for streams or wells.
- To prepare manuals like (Manual on Sewerage and Sewage treatment, Manual on Water Supply and Treatment, Manual on Solid waste Management), codes or guides for treatment and disposal of wastes etc.
- To establish or recognize laboratories for analysis of water samples from any stream, well or trade effluents etc.

### **1.6.3 Functions of the State Pollution Control Board**

- Planning a comprehensive programme for prevention control and abatement of pollution of streams and wells.
- Advising the state government regarding water pollution control or location of industries.
- Conducting and encouraging investigations and research relating to different aspects of water pollution.
- To collaborate with the Central Board for training personnel for handling water pollution programmes and organizing related mass education programmes.
- Inspecting trade effluents and wastewater treatment plants.
- Prescribing effluent standards for the sewage and trade effluents.
- Evolving economical and reliable methods of disposal treatment and reuse of wastewater.
- Laying down the standards of treatment of sewage to be discharged into any stream.
- Making, varying and revoking any order for preservation or control of discharge of waste into streams and wells or construction of systems for disposal of effluents.
- Establishing or recognizing laboratories for analysis of samples.
- Performing such functions as may be entrusted by Central Board or State Governments.
- Imposing penalties for the violation of the provisions of Acts.

## **1.7 CONCLUSION**

There are various laws, acts and the regulatory bodies at the central and state levels. They have different duties, functions and powers to control the air, water, soil, and noise pollution etc. But this is not sufficient. The main thing is the knowledge and urge of environmental protection. Why one should protect environment and how it can be done, this is to be understood clearly. As stated in this chapter that all the living and non-living things in this world are interlinked and interdependent. They are in a dynamic equilibrium with each other and cannot sustain in isolation. Every process is cyclic and the cycle depends upon every element of it. If an element is disturbed, destroyed or extinct the whole chain gets disturbed. The nature is a very good organizer. It has many alternatives for the climax conditions. But that depends upon the very existence of its diversity, the Biodiversity. Knowingly or unknowingly if we harm the natural cycles and the diversity, the system will collapse after some time. That time has come. So it is the duty of every citizen, everybody having some mind and brain, to think about its prevention and solution. Prevention is always better than cure. That is why we plead for prevention and control of environmental pollution. Let us make it voluntary, not mandatory as it is very difficult to impose laws, acts and rules regulations by force. The need is to propagate these novel ideas at the student level so that they can spread it in the society with their utmost zest and zeal.

## **REVIEW QUESTIONS**

1. What do you mean by environmental engineering? What is the role and duties of environmental engineer?
2. What is the need of protection of environment?
3. What are the adverse effects of environmental pollution?
4. Explain the biotic and abiotic environment and its interdependence.
5. Describe the different control strategies for the protection of environment.
6. Critically examine the need of environmental legislation.
7. Enlist the various laws made for protection of environment and mention the main aims and objectives of each of them.
8. What are the functions and power of the Central Pollution Control Board?
9. What are the functions and power of the State Pollution Control Board?
10. Enlist the various regulations and acts in chronological order.

**This page  
intentionally left  
blank**

# ***WATER POLLUTION***

---

## **2.1 INTRODUCTION**

Water is spread on two third of the earth but most of the water is not useful for direct human consumption. It is available as ice on the poles and the glaciers with a percentage of 2.14. The largest store is ocean with useless saline, brackish water (total dissolved solids more than 50000 ppm) having 97.24 per cent of total water. The total available fresh water (that can be used for irrigation and drinking) is 0.62 per cent. This fresh water is distributed in surface sources (rivers, lakes etc), ground water (shallow and deep), soil moisture and vapour in atmosphere. The surface water is only 1.5% of the total fresh water and most of the fresh water is the ground water. So the surface water is something around 0.01% of the total water. Because of its easy availability the surface water had been the main source of water for irrigation and drinking purposes. That is why all the old civilizations started on the banks of rivers. We gave a high respect to the rivers as mother Ganges, to show our gratitude for their blessings of water, the basic requirement of human life. Whenever a new planet is discovered we check if signs of water are there, and if yes, then we assume that life could be there.

This scarce limited water is becoming useless because of the human activity (pollution) and that is the main concern of study of water pollution.

## **2.2 WATER RESOURCES**

The various sources of water, which can be harnessed economically, can be divided into the following two categories:-

### **(A) Surface sources such as**

- (i) Ponds and lakes

- (ii) Streams and rivers
- (iii) Storage resources (dams)

**(B) Subsurface or underground sources such as**

- (i) Springs
- (ii) Wells (open and tube-wells)

All of the above water resources are replenished by precipitation in various forms like rain, snow, hail, dew etc. Rainfall is the main source and forms the major constituent of the hydrological cycle. Water gets evaporated from the various exposed bodies of water depending upon the climatic factors like temperature, R.H. and the wind speed. RH or the relative humidity is the ratio of the amount of water vapour present in the air to the maximum amount of vapour that air can hold at that given temperature. Actually, air can hold only a fixed amount of water vapour at a given temperature. As the temperature goes up, the moisture retaining capacity increases and as the temperature goes down, it reduces. That is the reason, why dew is formed at night when the temperature of the air falls down, and at that reduced temperature, the extra moisture (more than its capacity at that temperature comes out and is condensed in the form of dew). So if, for example, air can hold 3 gms of water vapour per Kg of air at 20°C and the moisture present in any sample of air (at this temperature) is 1.5 gms per Kg of air, then its RH will be- 50%. Lesser the RH of the air, higher the rate of evaporation as there is more deficits to be met with. Similarly, more is the difference of temperature (air and water) higher will be the rate of evaporation. Same is true with wind speed. Like this, depending upon the climatic factors, evaporation shall take place. The yearly evaporation from an exposed body of water in North India may be 1.7m per year. The trees extract the subsoil water and during their breathing process, they exhale water vapours into the atmosphere. This process is known as transpiration and the combined process of evaporation and transpiration is known as 'evapotranspiration'.

### 2.2.1 Rainfall

The water vapours get collected in the atmosphere and behave like a gas and obey the various gas laws (Boyle's, Charle's etc.) under normal conditions. The concentration of water vapours keeps on increasing and when it goes beyond the maximum moisture retaining capacity of air at that temperature, it comes out in the form of precipitation. Generally, it happens when air is cooled (hence the water retaining capacity is reduced). The usual mechanism by which air is cooled to cause precipitation is lifting of the air mass. There are three different methods by which the air mass gets lifted and gets cooled to cause precipitation, generally in the form of rain and sometimes as snow, hail, sleet etc. These are cyclonic precipitation, connective precipitation and orographic precipitation.

Cyclonic precipitation is by the lifting of an air mass due to pressure difference and consequent horizontal flow from the surrounding area.

Connective precipitation is due to the upward movement of the air that is warmer than its surroundings.

Orographic precipitation is the main cause of precipitation in India. Winds heavily laden with moisture (monsoon winds) from the Bay of Bengal strike the southern slope of Himalayas, causing intense rains.

**2.2.2 Distribution of Rainfall**

Buildings, trees and other obstructions, catch some of the rainfall, i.e. it is prevented from reaching the ground. The part of the rain, which comes to the ground, is known as the *ground rainfall*. After reaching the ground surface, infiltration of water to soil starts. depending upon the absorbing capacity of the soil, which reduces with the time of occurrence of rainfall. After some time, the rate of absorption reduces and the water starts flowing on the surface of the earth. This is known as *surface runoff*.

**2.2.3 Measurement of Rainfall**

In order to estimate the capacity of a water source, the intensity and duration of rainfall and consequent runoff are to measured. The simple measurement of the rainfall is done with the help of rain gauges. The rain gauges are open receptacle with vertical sides (bottle like) with funnels at the top, mounted at an unobstructed platform. They may

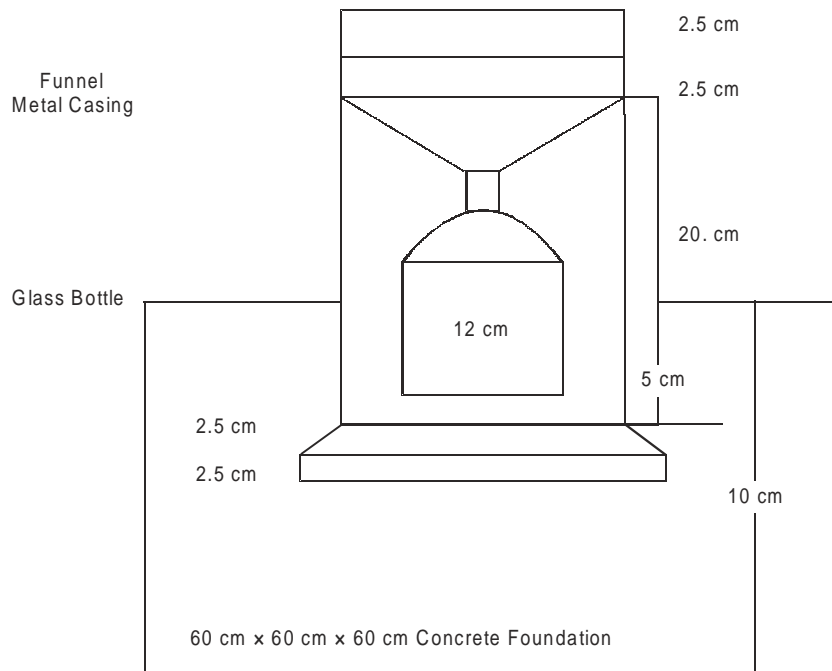

**Simon's Rain Gauge**



be non-recording type like Simon's rain gauge or recording type like tipping bucket type, weighing type and floating type etc. A float type gauge, which is most popular in India, consists of a rotating drum with a graph paper fixed around it. There is a pen point in contact with the graph paper, which moves up with the rise of the float. The float in turn rises up with the rainwater that is collected in the gauge chamber. The moving pen thus goes on recording the accumulation of rainwater with the passage of time. When the chamber gets filled up the rainwater collected in the chamber is drained out with the working of natural siphon.

In a *Tipping bucket gauge*, the rain water is first caught in a collector and then passed through a funnel. The funnel discharges the water into a double compartment bucket. When 0.1 mm of the rainwater gets filled up in one compartment, the bucket tips emptying into one container, and shifting the other compartment in the place below the funnel. The tipping of the bucket completes an electric circuit, forcing a pen to mark on the rotating drum. As this can be electronically transmitted to distances, such gauges are generally installed at remote/inaccessible places and the data can be recorded at comfortable control rooms.

The amount of water collected and recorded for one complete year is known as *annual rainfall* and the average of this annual rainfall for a number of designed years (say 30 years) helps us in planning and designing of various projects like water supply, irrigation, waste water management, storm water management, town planning etc. For estimating the discharge (volume of the water flowing per unit time  $\text{m}^3/\text{sec}$  or cumec, 1 cumec=35 cusecs) there are many empirical formulae, which are site specific. The one given by C.P.H.E.E.O manual on sewerage and sewage treatment is the most authentic, as it caters for the characteristics of the area etc. In the **Rational method**, the characteristics of the drainage district such as imperviousness, topography, shape of the drainage basin and the duration of the precipitation are considered to determine the discharge at a place. The runoff reaching a particular site is given by the expression

where,  $Q = 10 CiA$

$Q$  = runoff in  $\text{m}^3/\text{hr}$ ,

$C$  = co-efficient of runoff,

$i$  = intensity of rainfall in  $\text{mm}/\text{hr}$ ,

$A$  = area of the drainage district in hectares, area contributing the discharge.

The intensity of the rainfall decreases with duration. Analysis of observed data on intensity duration of rainfall of the past record, over a period of years in the area is necessary to arrive at a fair estimate of the intensity-duration for given frequencies. Frequency means number of times of the occurrence of a particular storm takes place, in a year. Longer records are required for dependable results.

In Indian conditions, intensity of rainfall adopted is usually in the range of 12mm/hr to 20 mm/hr. The co-efficient of runoff **C** depends on the imperviousness and the shape of the tributary apart from the duration of the storm.

The rational and the other formulae give us the runoff and are therefore, helpful in evaluating the amount of water available in the river or stream or *nallah* over long periods. They are therefore useful for estimating the storage capacity of the reservoir and thus fixing the height of the dam required to be constructed for that storage. These determinations are useful when a storage reservoir is to be used as a source of water. However when a river or a stream may be directly used as a source of water (without any reservoir) one has to determine the day-to-day quantities of flow in that river or stream. These daily flows are determined by actual observations and measurements over along period. Various methods of discharge measurements may be adopted such as the velocity area method or stage discharge relationship method, using a weir of any existing dam or by using control meters etc.

### 2.3 SURFACE SOURCES OF WATER SUPPLY

These are the sources in which the water flows over the surface of the earth and is directly available as raw water like lakes, rivers or impounding reservoirs. Ponds and lakes are suitable for relatively small water supply schemes. Direct withdrawal from rivers may not be possible throughout the year, so it is best to construct a dam or barrage (any solid obstruction in the flow of river) and then use the water stored in the created reservoir. Generally a dam is constructed for generation of hydroelectricity, irrigation and a measure against floods and draughts. So it is a multipurpose project and water supply is a small part of the project. Actually, the total yearly demand of potable water (drinking water) is very less (say 1% of the water required for irrigation purpose). So the dams (reservoirs), canals and other systems mainly designed for irrigation are simultaneously used for water supply.

The Indira Gandhi Main Canal flows in Rajasthan starting from Hari-ke-Barrage to Mohangarh in Jaisalmer about 600 km long. Many lift canals like Rajeev Gandhi Lift Canal for water supply to Jodhpur take water from the main canal. The flow in the main canal at the off take point of the Rajeev Gandhi Canal (RD1109 village Madasar, Jaisalmer) may be 10,000 cusecs out of which the water supply canal (Rajeev Gandhi Lift Canal) draws only 200 cusecs.

Similarly, Kota Barrage is constructed to divert the Chambal River's water to right and left main canals for irrigation. The right canal flows for about 80 km, irrigating Rajasthan and M.P. areas. But water is also drawn for the supply of potable water to whole of the Kota city throughout the year, 24 hours a day at the rate of 250LPCD.

Bisalpur dam has been constructed in Tonk district for irrigation. Water for drinking is supplied to Ajmer and is planned up to Jaipur also.

These were a few examples only in Rajasthan. Throughout the country, many such multipurpose projects are there.

Sometimes the lakes are also used for water supply, like the Powai Lake for Mumbai. Actually, it depends upon the amount of water stored in a body of water (reservoir), may it be a lake or an impounding reservoir, and the demand of (raw) water to be supplied to a nearby locality that it may suffice or not. Sometimes, because of the paucity of surface water sources and the non-availability of good quality water (acceptable as per health norms) water has to be carried from long distances. For example, the Rajeev Gandhi Lift Canal is 200 km long and water is carried for this much long distance with 8 pumping stations with approximately 200m lift. The electricity expenditure in lifting the whole water for such distances makes the raw water very costly. But there is no other choice.

The ground water is deep at places of scanty rainfall. Generally, the salts available in the soil gets dissolved in the ground water and they make it unfit for human consumption. Fluoride is the main culprit. Most of the towns in Rajasthan have ground water with more fluoride content than the permitted ( $>1.5$  p.p.m.). In other states also, the ground water has generally more than the permissible amount of dissolved solids. Making water free of dissolved solids is very costly. So it is wise to construct some obstruction in uselessly flowing water to make it useful. Otherwise, the water will either ultimately flow into the seas and oceans, or will evaporate into the atmosphere. This is known as *water management*.

Even if the surface water goes deeper into the earth to enhance the ground water, it is beneficial as it increases the underground safe deposit, which can be used by us, though it contains more salts and energy is required to take it out. But the water, which is neither available on earth nor mixed with ground water i.e. the subsoil water, is generally useless. It can only be extracted by the angels like trees, which act as a pump to lift this subsoil water to the atmosphere through transpiration. Thus it is wise to take care of every drop of rainfall falling on the earth, so that it may not go waste. This requires a holistic approach. The requirement of the whole nation should be considered and the projects should not be dealt in isolation. Water cannot belong to a particular village/town or a state. It is a national property and it should be planned in such a way that it reaches to an Indian wherever he/she is living in the country. Some rivers have surplus water and some are deprived of it. They may be linked with each other, with care of possible environmental impacts. We have developed such ways and means to assess the environmental impacts of any project (discussed in detail in chapter no. 7) It is not wise to reject such ambitious and important projects for some unquantified fears. On the other hand as it is against the nature's present system, so one has to be very careful in considering the overall cost and benefits ratio. It is true that the increasing population is exerting more and more demand on the available resources and for filling the gap between demand and supply (here water demand for drinking and water supply through surface or underground sources) we are disturbing nature. The nature is elastic to some level only and after its endurance limit it may become violent and we may have to face serious repercussions. So conservation of water is the

best policy with its wise and thoughtful use. In the present context, the construction of dams is unavoidable. However the role of the environment engineer is to maximize the benefits and minimize the drawbacks.

For making a permanent surface source for water supply a suitable type of dam is constructed which may be any one of the following: -

- (i) **Earth Dam:** An earth dam is made of earth (or soil). It resists the forces exerted upon it mainly due to shear strength of the soil. Though the weight of the earth dam also resists the forces, but the structural behavior of an earth dam is different from that of a gravity dam (Stone or concrete dam). When the valley is wide and foundation is less strong, good soil is available; earth dam is a good option as it is more environment friendly.
- (ii) **Gravity Dam:** A gravity dam is made of stone and concrete, and resists the water pressure, uplift pressure, wind pressure etc. due to its weight. They are more suitable for narrow valleys with steep side slopes and strong foundation because of more weight. They are strong and costlier than earth dam.
- (iii) **Rock fill Dam:** A rock fill dam is like a combination of the two mentioned above. The inner segment consists of rock pieces, boulders etc. with an impervious outside membrane. Sometimes it has an impervious earth core to check the seepage. They are less strong than the gravity dam and used for limited heights only, particularly when the rock pieces are abundantly available.

Some less common dams like arch dams, buttress dams, steel dams, timber dams are also there, and even rubber dams are used these days at small levels.

In all types of dams, selection of site for a dam is most important. The selection of site includes the consideration of topography of the area, suitable foundation, spillway (outflow) site, availability of materials, watertightness of reservoir made, submergence due to the construction of reservoir including the rehabilitation of the displaced over, accessibility, sediments problem, the direct and indirect benefits of the dam and the minimum overall cost (including all environmental impacts).

### ***Storage Capacity of Reservoirs***

The main function of constructing a dam and a reservoir is to store water at the time of monsoon and then to use it throughout the year for irrigation drinking and other processes. So the storage capacity of the reservoir is its main feature. First of all a suitable dam site is selected considering many aspects like the flood discharge, requirement of the water, geological conditions, shape of the valley (cup or saucer shape), foundation requirements, availability of construction material and machinery etc. Then the capacity of reservoir is determined from the contour maps of the area. The survey of India department of Government of India has surveyed the whole country and has made the topographic sheets known as the Great Trigonometric Survey Sheets (G.T. Sheets). They are available on different scales for different purpose. Then the area enclosed

within each contour in the reservoir site is measured with a planimeter (a small equipment to measure an area on a map). The contour elevations (from GT sheets) and the areas measured are plotted in the form of a curve known as area elevation curve. The integral of the area elevation curve gives elevation=storage or elevation capacity curve. The volume of water that can be stored in a reservoir at a certain water surface level can be computed after determining the increment of storage between two elevations ( $\Delta S$ ). The increment of storage ( $\Delta S$ ) between two elevations is usually computed by multiplying the average of the area at two elevations, by the elevation difference ( $\Delta h$ ). The summation of these increments below any elevation gives the storage volume below that level.

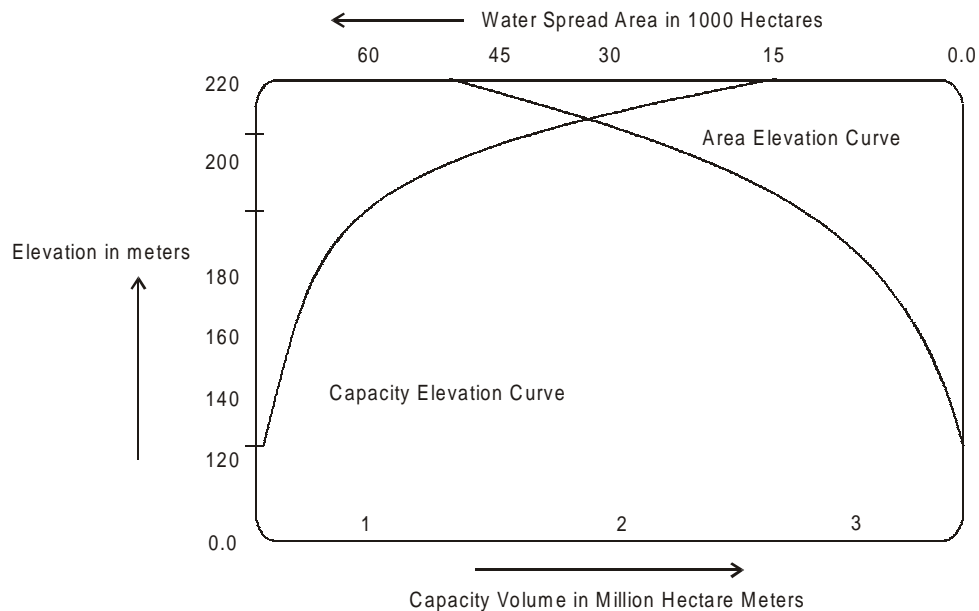

#### **The Area Elevation Curve**

Actually this is an old method. These days the plots are made with the help of remote sensing and the Geographical Information System (G.I.S.). Then with the help of computer software the capacity of reservoir below a certain level can be easily made known.

Depending upon the requirement of water, for all intended purposes and the availability of budget the height of the dam is decided. Actually the water requirement for irrigation is much more in comparison to that for drinking (all domestic purposes). It may be 100 times more for instance. The second consideration is the area of submergence. It depends upon the shape of the reservoir, so a deep valley is preferable to store more water for lesser spread of submerged area. The area under submergence is generally

forest and the if the valuable forestland with trees and other vegetations are submerged it is an actual loss to the environment. The other details about this are given in the chapter on Environmental Impact Assessments.

## 2.4 SUBSURFACE OR UNDERGROUND SOURCES

The rainwater that gets infiltrated and percolated inside the earth to form a uniform water surface is known as the ground water. This water is comparatively pure because of the natural filtration as it passes through the soil. Many impurities are retained by the soil through the actions like screening, sedimentation, adsorption etc. But it dissolves many soluble salts as it passes through the soil containing those salts. So the total dissolved solids of the underground water are much more than the surface water. The flow of rain water from surface of earth to the underground depends upon the porosity of the soil, the rate of water loss by evaporation, seepage to surface sources and withdrawal by us.

### 2.4.1 Porosity

The porosity of a stratum (soil or rock) is a quantitative measurement of the interstices of the voids present in a given volume.

Mathematically porosity = Volume of voids/total volume

So the porosity  $\eta = V_v/V \times 100$  (per cent)

Where  $V_v =$  Volume of voids

$V =$  total volume

Porosity depends upon shape and arrangement (packing) of the solid particles. Uniformly graded (same size and shape) particles are more porous whereas those with different size and shape are well packed and thus have poor porosity. Sands may have 30 to 40% porosity whereas the slate or granite may have 1 to 4% porosity only.

### 2.4.2 Permeability

The permeability is defined as the ability of rock or soil stratum to transmit or pass water through itself. Water enters in the pores (voids) of the rocks, and is stored there until it is drained off. The 'porosity' of the rock thus defines the maximum amount of water that can be stored in the rock. The porosity in itself does not ensure the storage of underground water. Actually the water can enter into a rock (with any porosity) only if the rock permits the flow of water through it, i.e. it depends upon whether the rock is permeable or not. So a rock that is porous may not be permeable. For example shale is a porous rock but not permeable. Its pore spaces are so minute and not well connected to each other that the shale is impermeable. The permeability is defined in terms of coefficient of permeability  $k$  (m/sec.). It has been well defined by the Darcy's law.

**Darcy's Law:-** Scientist H. Darcy demonstrated on the basis of experiments that for the laminar flow conditions ( Reynolds number  $< 1$ ) the discharge, passing through

a soil is proportional to the head loss  $\Delta H$  and the area of cross section  $A$  of the soil and inversely proportional to the length ( $L$ )

So  $Q \propto \Delta H/L \cdot A$  ( $\Delta H/L$  can be designated as hydraulic gradient  $i$ )

or  $Q \propto i A$

or  $Q = k i A$

The above equation gives the dimensions of  $k$  as m/sec. That is the unit of velocity. One more term is transmissibility. Scientist Theis defined transmissibility as the rate of flow of water through a vertical strip of water bearing stratum (aquifer) of unit width and full depth ( $d$ ) under a unit hydraulic gradient and a temperature of  $60^\circ \text{F}$ .

Thesis'  $T = k d$

The following table gives the porosity and permeability of some of the formations

**Table 2.1 Porosity and Permeability of Some Soils**

S. No.	Type of formation	Porosity	Permeability
1	Granite, Quartzite	1.5%	
2	Slate, Shale	4%	
3	Limestone	5 to 10%	
4	Sandstone	10 to 15%	
5	Gravel	25%	1.0 or more
6	Sand and gravel	20 to 30%	1-0.1
7	Only fine sand	35%	0.05-0.001
8	Silty sand	-	0.002-0.0001
9	Silt	-	0.0005-0.00001
10	Clay	45%	0.000001 or lesser

## 2.5 GROUND WATER YIELD

The ground water is present in the water bearing stratum. Those soil formations through which it can be easily and economically extracted is known as aquifers. The top layer of ground water is known as water table. The ground water may come out by itself either through springs or sometimes as artisan wells, but generally extracted out through the wells. Larger diameter wells are known as open wells whereas the smaller diameter wells (30 cm or so) are known as tube-wells. Tube-wells are drilled by machines and fitted with blank or perforated pipes (strainers to draw water). Different type of pumps are installed in the wells to get the water on ground surface. These days generally submersible pumps are lowered in the tube-wells and open wells capable of drawing water for various heads and discharges. As soon as the pumping is started the ground water table goes down and a cone of depression is formed as shown below



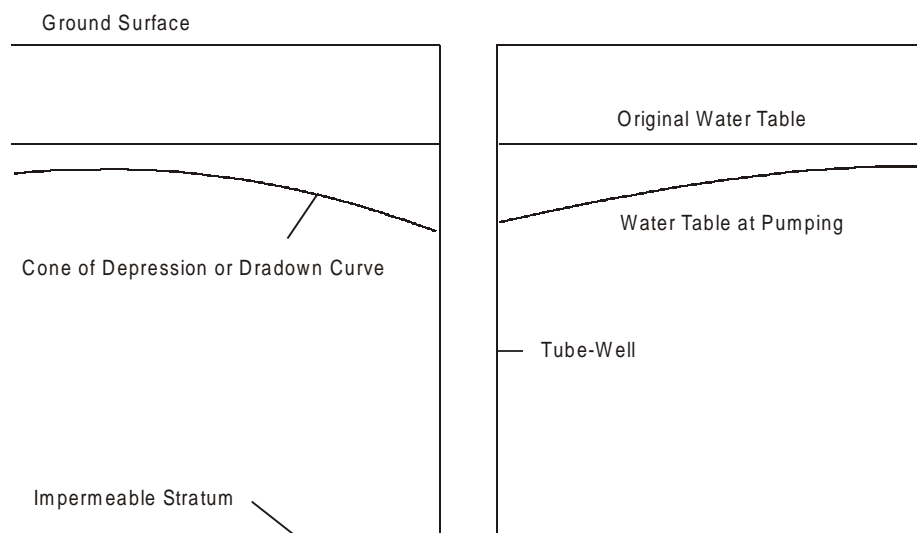

After sometime the equilibrium is achieved, depending upon the yield (capacity to provide water) and the withdrawal capacity of the pump set. If the yield of the aquifer is more than the capacity of the pump installed we get continuous supply of water, but if the pump has larger withdrawal capacity than the yield, then the supply of water shall stop. The supply shall start again after sometime after further accumulation of water from distant places in the aquifer. So the yield is known as the quantity of ground water that can be extracted from a saturated (all voids filled up with water) water bearing stratum. The ratio of this volume of water to the total volume of the stratum is known as the specific yield. It is expressed in percentage that this much per cent of water may be extracted from the soil economically. The water that cannot be extracted is known as the specific retention or field capacity.

This specific retention is the amount of water held between the grains due to molecular attraction. This film of water is thus held by molecular adhesion on the walls of the intrices. Therefore the amount of this water will depend upon the total interstitial surface in the rock. If the total interstitial surface is more, the specific retention will be more and vice-versa. In soils like clay as the specific area is more, the specific retention would be more and hence it will result in a small specific yield. Similarly in large particle soil like coarse gravels, the specific retention would be smaller and it will give large specific yields. After drilling the tube-wells by drilling machines the hydro-geologists make a log chart of the stratum and then decide the position of blank and perforated pipes depending upon the rock formation (aquifer). Tube-wells may be shallow or deep depending upon the depth of water table, yield of the aquifer and the requirement of water. The drilling operation of the well depends upon the expected soil structure.

### 2.5.1 Drilling of Tube-Wells

Tube-wells can be drilled by following methods:



**(i) Auger Drilling** (upto 15 m)

For smaller depths and smaller diameters auger drilling can be used in clay silt or sand. The auger may be hand operated or power operated. Some of them are as shown below.

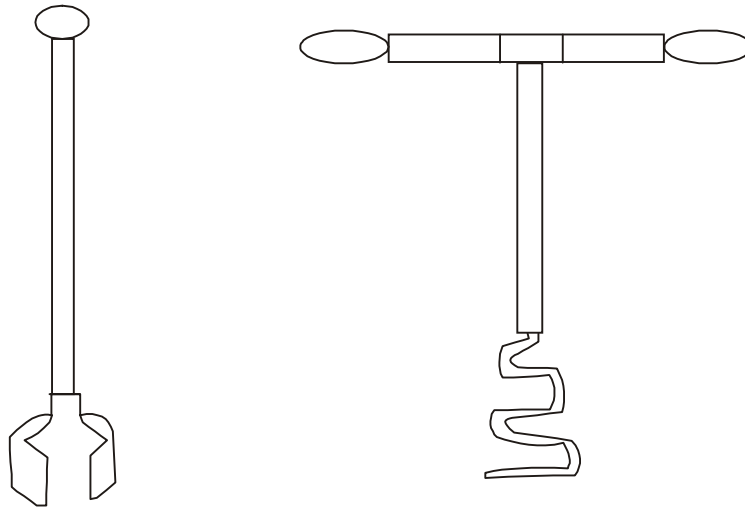

This type of drilling is possible only in soft soils. To support the soft soil casing pipe are lowered simultaneously.

**(ii) Water jet or Wash Boring**

In water jet boring method, a drill bit with nozzles is attached to the drill pipe at its bottom. Water under high pressure is pumped into the drill pipe. The force of water jet coming out of the nozzle loosens the subsurface soil. The returning water flow through the annular space between the borehole and the drill pipe carries the cuttings along with it to the ground surface. Here also the soft soil is supported by the casing pipe to avoid collapsing in. The method is not suitable for hard soils.

**(iii) Core Drilling**

This method is used for hard soil. In this method a core cutter with steel teeth (drill bit) attached to a drill rod rotates and thus cuts the hard soil. As the soil is cut and the hole is formed water supplied through the drill rod removes the cuttings. For extremely hard and strong soils diamond bits are used.

**(iv) Percussion Drilling**

In this method a drill tool string constituting of a drill bit, a drill stem, and a drill jar is lifted up and dropped down by connecting it to a diesel engine and a winch. The cable tool bit acts as a mini crusher that chops the

consolidated formations. After the bit has chopped the formation for 1 to 1.5 m it is taken out of the hole and a bailer is inserted to remove the cuttings. Water makes slurry with pulverized materials that is bailed out. As the bailer is lifted, the flap valve closes and it brings with it the cuttings to the ground. Casing is used simultaneously in soft (unconsolidated) formation. The method is suitable for drilling holes 20 to 50 cm in diameter and upto 150 m deep.

(v) **Rotary Drilling**

This method is suitable for unconsolidated clay and sand formations as well as coarse gravel and boulders including soft rocks. In this method the rotating drill bit makes the bore hole. The mud slurry, generally bentonite is pumped down through the drill pipe as the drilling proceeds. This mud rises to the ground surface along the walls of the hole and carries with it the cuttings. The mud also strengthens the walls of the hole to prevent falling in. The following figure shows the schematic diagram of the Rotary drilling.

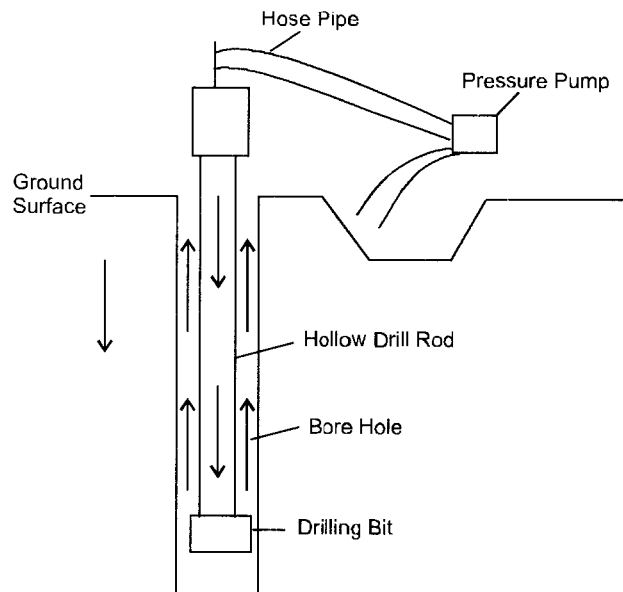

(vi) **Down the Hole Hammer Drilling (DTH)**

In this method of drilling a pneumatically (by air pressure) operated hammer is used at the lower end of the drill pipe. Thus it combines the percussion effect of the cable tool method and the rotary action of the rotary drilling. As the drilling proceeds the hammer crushes the rock into small chips. A flush pump is used to flush out the hole and bringing the cuttings to the ground surface through the annular (circular) space between the bore hole and the drill pipe. Small diameter holes upto 30 cm can be successfully drilled in medium to hard

soil by this method. After drilling the hole and taking samples of the cuttings (removed soil) at regular intervals the pipe assembly is designed for blank and perforated pipes. Specially designed perforated pipes are known as strainers. They are designed to allow water to come inside the hole and the soil is prevented to get inside it by their special shape. That is why they are costlier than the blank pipes, so they are placed only in water bearing and yielding stratum (aquifer). There are many type of strainers like Cook Strainer, Ashford Strainer, Legget Strainer, Phoenix Strainer etc.

### 2.5.2 Lowering of Pipes and Gravel Packing

The pipe assembly consisting of blind pipes (without hole) and strainers (with well designed holes) are lowered in the drilled hole to a depth as designed by the hydrogeologist. The design of assembly is based on the depth of static water table, expected draw-down (lowering of water table in a conical shape), expected yield and the requirement of water. The diameter of the drilled hole is bigger than this pipe assembly and thus some space is left between the walls of the hole and the tube-well pipe. This space is filled up with gravel of suitable size. The casing pipe to retain the hole is taken out simultaneously. The process of filling gravel (to stop entry of fine particles at pumping) is known as shrouding. This also increases the effective well diameter and hence the yield of the well. After shrouding the well is developed for use.

### 2.5.3 Development of Tube-wells

Development of a tube-well is the process of removing fine material from the aquifer surrounding the strainer pipe so that it does not cause choking at the time of pumping. It increases the yield from a tube-well and increases the useful life of the well. Following methods may be used for developing a tube-well:-

(i) ***Pumping Method***

In this method the fine particles surrounding the well are agitated by the working of a variable discharge pump that gives jerks by its irregular motion. Slowly the speed of the pump is increased until no more fine particles come out with water.

(ii) ***Surging Method***

In this method a hollow surge block or a bailer moves down the hole, already filled up with Calgon (Sodium hexa meta phosphate) a dispersing agent, forces it to the holes of the soil. When the bailer is moved upwards, a suction pressure is developed and the water calgon solution brings with it fine particles into the well. The surge block (bailer) is connected to a hollow pipe through which the water charged with fine particles is pumped out. This operation is repeated till clear water comes out from the well.

**(iii) Compressed Air Method**

In this method, the development of the tube-well is done with an air compressor discharge pipe and an air pipe. The air pipe is placed in the discharge pipe such that its lower end projects out of it by a small length. This assembly is lowered into the well till it reaches the bottom of the strainer pipe. After building a high pressure of air in the compressor ( $800 \text{ kN/m}^2$ ) the air valve is opened suddenly to release the air with high pressure. This loosens the fine particles in the formation surrounding the slots. When the air valve is closed the pressure decreases and water enters the well alongwith the loosened fine particles. This water is pumped out of the well. The same operation is repeated at different levels along the strainer sections of the tube-well so that the whole well is fully developed.

**(iv) Dry Ice Method (Chemical Method)**

In this method sodium dioxide (dry ice) and hydrochloric acid are used. First of all HCl is poured in the well and the well is closed from the top. Compressed air is supplied which pushes the HCl into the voids of the soil. The top plug is then removed and dry ice blocks are dropped which sublimate to release  $\text{CO}_2$  which builds up a high pressure. This high pressure gas comes out of the tube-well with pressure followed by the water mixed with mud in the form of a jet. This way the fine material; are removed and the well starts giving clean water.

**2.5.4 Yield of a Tube-Well**

The yield (discharge) of a tube-well depends upon the depth and capacity of aquifer (water bearing stratum) and the drawdown. As the water comes to the tube-well from all directions the Dupuit- Theim equations can be used to obtain the yield from it. There are two cases, first in which the water bearing stratum has no upper impermeable layer (confining it to some limited depth), and there is only one impermeable layer at the bottom of the aquifer. This type is known as the unconfined aquifer. In the second case there are two impermeable layers, one at the top and other at the bottom of the aquifer, known as confined aquifer.

**2.5.4.1 Yield of a tube-well in an unconfined aquifer**

Let there be a well of radius  $r_w$  fully penetrating an unconfined aquifer of thickness  $H$  below the water table (top surface of ground water) that is horizontal in the beginning. As soon as the water is pumped out of the well the water level near the tube-well goes down and this horizontal surface is converted into a conical curved surface as shown below.

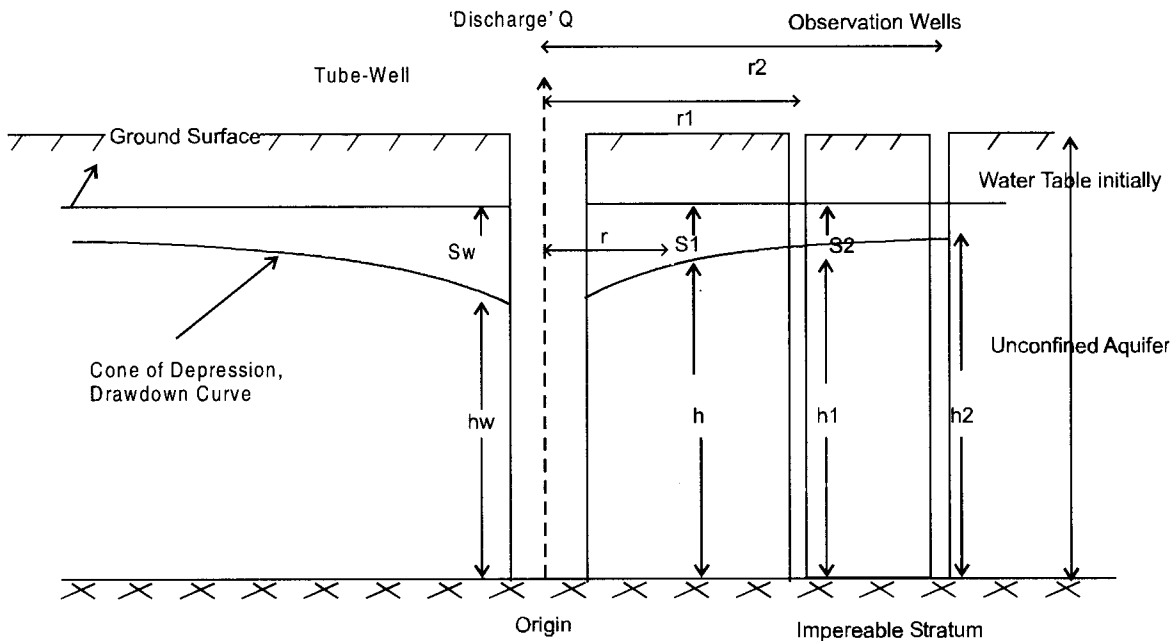

When the water is pumped through the well at a constant rate  $Q$  for sometime, the lowering of water table near the tube-well (drawdown) comes to some final constant level, depending upon the capacity of supplying water by the soil and the power of the pump to draw water (discharge). Higher is the withdrawal capacity (discharge) of the pump and lesser is the supplying capacity of aquifer more will be the depth of the drawdown. In extreme case if this drawdown curve reaches the bottom of the aquifer means the demand is more than supply, water will stop coming out of the tube-well until it again gets filled up by resuming water from far places. Keeping this in mind the submersible pump should be lowered at a depth which is more than the worst expected drawdown. This is the reason that sometimes water mixed with air comes out from tube-wells and hand pumps (a type of small diameter tube-well operated manually). Or in extreme cases only air comes out. Here lies the necessity of recharging the aquifer by rain water. The over exploitation of underground water without, or less, recharging by rainwater has converted the good aquifers into dark zones. Presently we are drawing more and more water with tube-wells for irrigation and drinking purposes as the demand is growing exponentially. Nobody cares about the penetration of rainwater (runoff) through the soil to the under ground water. We have made houses, roads and other pucca structures which increases the flow of water (runoff) to the rivers from which most of it goes to sea and gets converted into useless saline, brackish water. Otherwise if it is collected in ponds or reservoirs it gets evaporated easily as it is exposed to atmosphere i.e. about 1.7 m/year in northern India. Had it been stored below the ground as underground water there would have not been any evaporation etc. In this

case it would have been away from the surface pollution and rather it would have been automatically purified due to the natural filtration process. So it is wise to conserve rain water under the ground and use it only in a calculative, judicious manner.

Unfortunately in most of the areas in India the underground water is either going deep and deep or has become so polluted to be useless for human consumption. Actually we have to spent much more electricity if the water is to be lifted from a greater depth. The horse power of the pump that is directly related to the electric consumption (1H.P. = 0.746 kW) is based upon the discharge and head (depth of water) as follows:-

$$\text{Horse Power} = Q H/75 \times \eta$$

Where  $Q$  = discharge in litres per second

$H$  = head in meters

$\eta$  = efficiency of the pump

So deeper is the water higher is the head and there is a larger requirement of the HP of the pump. As 1 HP = 0.746 kW and when 1 kW motor runs for one hour it consumes 1 kWh. *i.e.* one unit of electricity, the consumption of electricity increases directly with depth of water.

Now let us derive a mathematical expression for the estimation of discharge from a tube-well. For this derivation let us consider a cylindrical soil mass around the well (the wells are circular for the ease in construction and stability). Let the origin of the cylindrical co-ordinates ( $r$ ,  $\theta$  and  $h$ ) be at the center of the bottom of the well. Let P be a point on the drawdown curve at a radial distance of  $r$  and at a height  $h$  above the impermeable stratum. Water flows to the vertical sides of the tube well passing through the point P. The area of flow  $A = 2\pi rh$

Darcy's law gives the velocity of flow  $V = ki = kdh/dr$

Where  $k$  is the co-efficient of permeability

And  $I$  is the hydraulic gradient

$$\begin{aligned} \text{Discharge } Q &= A \cdot V \\ &= 2\pi rhkdh/dr \end{aligned}$$

$$\text{or } h dh = Q/2\pi kdr/r$$

Integrating between limits  $r = r_1$  and  $h = h_1$  to  $r = r_2$  and  $h = h_2$

$$\int_{h_1}^{h_2} h dh = Q/2\pi k \int_{r_1}^{r_2} dr/r$$

$$\text{or } (h_2^2 - h_1^2)/2 = Q/2\pi k \log_e(r_2/r_1)$$

$$\text{So } Q = \frac{\pi k(h_2^2 - h_1^2)}{\log_e(r_2/r_1)}$$

$$\text{or } Q = \frac{\pi k(h_2^2 - h_1^2)}{2.303 \log_{10}(r_2/r_1)}$$

$$\text{or } Q = \frac{1.36k(h_2^2 - h_1^2)}{\log_{10}(r_2/r_1)}$$

#### 2.5.4.2 Yield of a tube-well in a confined aquifer

Similarly an expression can be developed for discharge through a confined aquifer. The following figure shows the flow system around a well fully penetrating through a confined aquifer of thickness say  $b$ . At the study state, when the final cone of depression has been established the rate of withdrawal is equal to the rate of water supply from the aquifer.

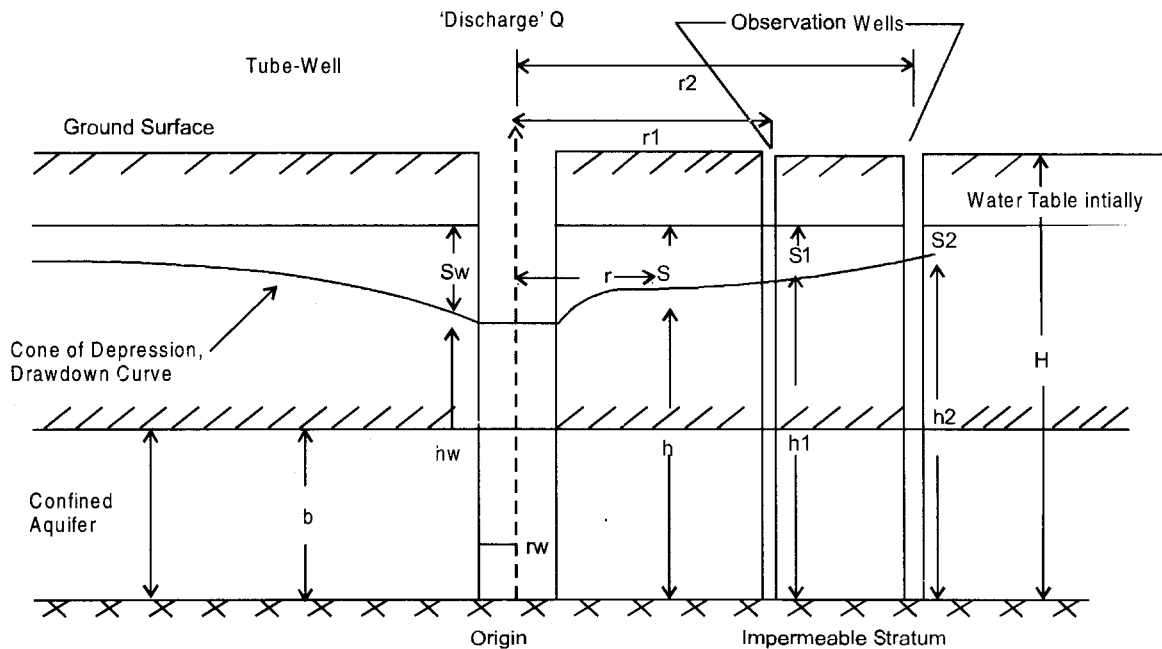

Let us consider the flow through the vertical sides of a cylindrical surface passing through a point P at a distance  $r$ . In this case as the depth of the aquifer is only  $b$  so the area of flow is equal to  $2 \pi r b$

$$\begin{aligned} \text{Using Darcy's law } Q &= (2\pi r b) \cdot k \cdot i \\ &= 2\pi r b k \frac{dh}{dr} \end{aligned}$$

$$dh = \frac{Q}{2\pi k b} \frac{dr}{r}$$

Integrating between limits  $r = r_1$  and  $h = h_1$  to  $r = r_2$  and  $h = h_2$

$$\text{or} \quad dh = \frac{Q}{2\pi kb} \int_{r_1}^{r_2} \frac{dr}{r}$$

$$\text{or} \quad Q = \frac{2\pi kb(h_2 - h_1)}{\log_e(r_2/r_1)}$$

$$\text{or} \quad Q = \frac{2.72kb(h_2 - h_1)}{\log_{10}(r_2/r_1)}$$

The above equation can also be written in terms of drawdowns  $s_1$  and  $s_2$

$$\text{As} \quad h_1 = H - s_1$$

$$\text{And} \quad h_2 = H - s_2$$

$$\text{or} \quad Q = \frac{2.72kb(s_1 - s_2)}{\log_{10}(r_2/r_1)}$$

In terms of transmissibility  $T = bk$

(Transmissibility  $T$  is equal to the discharge rate at which water is transmitted through a unit width of an aquifer under a unit hydraulic gradient )

The above equation becomes

$$Q = \frac{2.72 T (s_1 - s_2)}{\log_{10}(r_2/r_1)}$$

Integrating equation between the limits  $r = r_w$  and  $h = h_w$  to  $r = R$  and  $h = H$ , here  $R$  is the radius of influence that is the radius at which the cone of depression touches the original water table. It ranges mostly between 150 to 500 m. It can be estimated from Sichard's formula as  $R = 3000 S_w \sqrt{k}$

$$Q = \frac{2\pi bk S_w}{\log_e\left(\frac{R}{r_w}\right)}$$

Where  $S_w =$  drawdown in the well (m)

And  $k$  is the co-efficient of permeability.

Actually it is difficult to estimate the radius  $R$  accurately because the cone becomes asymptotic (meeting at infinity) to the water table. An average value of  $R = 300$  m is generally assumed.

$$\text{So} \quad Q = \frac{2\pi bk(H - h_w)}{\log_e(R/r_w)}$$

$$\text{or} \quad Q = \frac{2\pi bk s_w}{\log_e(R/r_w)} \quad (\text{As above})$$



$$\text{or} \quad Q = \frac{2\pi T s_w}{\log_e(R/r_w)}$$

$$\text{or} \quad Q = \frac{2.72 T s_w}{\log_{10}(R/r_w)}$$

Like this knowing the  $T$ , co-efficient of transmissibility,  $s_w$  the drawdown at the tube-well (can be measured) and assuming  $R = 300$  m, measuring the radius  $r_w$  we can estimate the discharge  $Q$ .

Sometimes the underground water may be tapped through the infiltration galleries which are a sort of horizontal wells constructed at shallow depths along the banks of a stream. Sometimes the underground water is also tapped at a local level by a very wide open well known as *Baori*. Actually *Baori* is a stepped well in which one can step down to the water level and fetch the water manually. These step wells were constructed in old times at places where the underground water was not very deep.

This way the water below the ground may be used as a source of water supply.

## 2.6 BASICS OF THE WATER SUPPLY SCHEMES

Actually wherever a water supply scheme is framed (scheme means a system to draw water from suitable source, treat it and then supply it to the consumers) a comparison is made between all the possible solutions. Preference is given to the nearest possible source as the conveyance of water is very costly. The underground water is generally pure (from suspended impurities point of view because of natural filtration) but contains more dissolved salts. The lifting of water (pumping out from wells) also requires energy (electricity) whereas the filtration of surface water is a costly affair. So the environmental engineers in the public health engineering departments (water works) make schemes (plans) to supply potable (fit for drinking from all points of view, i.e. clarity, dissolved salts, and free from bacteria etc.) water to the consumers. The schemes are basically of two types, **rural water supply schemes** and **urban water supply schemes** depending upon the population of the habitation. The standards for the two types are different. For example the designed rate of water supply per person per day in rural areas is only 40 litres (except the 11 desert districts of Rajasthan where it is 70 L.P.C.D. including the cattle water demand). The designed rate of water supply for urban area is minimum 135 L.P.C.D. and above for industrial and commercial demands depending upon the population of the city. Similarly, the availability of electricity in rural area is assumed as 8 hours per day whereas it is 20-22 hours per day in urban area. The rate of increase of population is also different in rural and urban area for forecasting the population for the designed period.

The next criteria is the source. Generally when there is no water or the quality of water available at some place is not fit for drinking or its harnessing is not economical

(very deep), water is pumped through pipe lines or conveyed through canals from distant places. For example water is carried through 204 km long Rajeev Gandhi Lift Canal originating from R.D 1109 of Indira Gandhi Main Canal in Rajasthan for Jodhpur city and many enroute villages. The Indira Gandhi Main Canal originates from Hari-Ke Barrage and flows by gravity for about 600 km. The water in Rajeev Gandhi Lift canal is lifted at 8 places for about 200 meters for conveying it to Jodhpur. This involves a great expenditure on electricity, construction and maintenance of canal. Some portion of this canal is made up of mild steel pipes where the construction of canal was not economical. So all these aspects like surety of availability of water, quality of water, cost of treatment, cost of supply etc. are to be considered before making a final decision. Some of the water supply schemes are as follows:

**(i) Traditional Source scheme:** In this scheme the traditional source of the water supply already existing in the village like an open well or the pond is electrified and pumping machinery is installed. The pumped water is distributed to the villagers by the existing small tanks near the wells. After commissioning the scheme it was handed over to the villagers to run at their own cost through the Panchayats (local bodies of the villages). But the schemes were not run by them successfully due to lack of interest and money. Government of Rajasthan has started a new project namely 'Swajaldhara' in which the villagers frame their own water supply schemes and pay 10% of the cost to the government. Government pay 90% and get the scheme executed and hand it over to the villagers to run it at their own cost under the guidance of the government. Many N.G.Os (Non-Governmental Organizations made voluntarily for the service of the society) help them for this purpose. At present this is running well in some districts of Rajasthan.

**(ii) Pump and Tank Schemes:** In these schemes the government public health departments develop a source in the village itself. It may be an open well or a tube-well generally. One ground level reservoir (G.L.R.) is constructed and the pump installed on the source fills water in this tank. Public stand posts (P.S.Ps) are constructed by the sides of this GLR and public is allowed to fetch water from here **free of cost** but no hose connections are given.

**(iii) Regional Water Supply Schemes:** When there is no feasible source of water in a village (water may be very deep or saline), then the water has to be carried from distant places like some other village well with enough potable water or some canal or river. So this is a combined scheme of many villages. Pipe lines have to be laid to carry water from the source to the benefited villages. So it is a costlier option. Water is generally supplied at one or two points in the villages free of cost. Some times connections to individual houses are also given depending upon the population and the paying capacity and willingness of the consumers. There are some regional water supply schemes which cater the needs of hundreds of villages alongwith the urban towns in Rajasthan like the Rajeev Gandhi lift canal water supply scheme, Ganddheli-Sahawa scheme, Bisalpur Ajmer, Jaipur scheme and many others. The Rajeev Gandhi

Scheme originates from RD1109 of Indira Gandhi Main Canal, constructed and maintained by the Irrigation Department of Rajasthan. The Public Health Engineering Department of Rajasthan (PHED or more commonly known as Water Works) has constructed about 204 Km long Rajeev Gandhi lift canal. In this water is lifted at 8 places before it reaches to Jodhpur so it is known as a lift canal. The discharge in the first phase was about 200 cusecs which has been raised in the second phase for the increased population and addition of more and more villages. This is one example of a big Reg. Water Supply Scheme. Thousands of other Reg.W.S.S are running in Rajasthan because generally either there is no water or saline, brackish, fluoride water is there in most of the villages of Rajasthan. This option is very costly because of the capital cost of long lengths of conveying mains (canal or pipes), maintenance cost and the electricity cost of pumping in lifting of water. As a primary estimate the cost of raw water in Rajeev Gandhi lift canal comes as Rs. 40 per thousand litres and the government charges at the uniform rate of Rs. 4 per thousand litres from the average domestic consumer. One should realize it and conserve water.

**(iv) Piped Water Supply Schemes:** These are generally for towns or big villages (urban areas). In these schemes house connections are given and the consumption is charged. The source may be in the locality or a distance source ( like Rajeev Gandhi lift canal for Jodhpur). R.C.C. Overhead tanks known as elevated service reservoirs (E.S.R) are constructed for the distribution of water through the distribution mains. First of all the raw water is treated by all means including disinfection (most important). Then pumped to ESRs and then distributed either for the whole day or at certain fixed time. The consumption is generally metered and charged on monthly basis. After some years the existing water supply schemes are reframed and executed. Such schemes are known as Reorganized Water Supply Schemes.

**(v) Urban Water Supply Schemes:** These are the schemes implemented for the urban areas. The main difference of urban and rural area is the population. Generally more than 10000 population is considered as urban area. The main difference in design of rural and urban water supply scheme is the rate of water supply. The design rate of water supply in rural areas as per the governments norms is 40 litres per capita per day except the 11 desert districts of Rajasthan for which it is 70 LPCD (including the cattle water demand). For urban area the rate is 135 litres minimum and it increases with the population. The other main difference is the house connections. In most of the rural water supply schemes water is supplied at a common point and people have to fetch it from this common place also known as public stand post. In urban water supply schemes every house is given a metered or flat rate service connection through which water is generally supplied intermittently (say twice in a day). The water obtained from a surface or ground source is treated and lifted in an elevated service reservoir. Then it is distributed through a properly designed and maintained distribution system. Though some of it is wasted in leakages but the loss should not be more than 10%. The water is also supplied for

industrial and commercial purposes. Some of the water is always stored for fire fighting. As there is a depletion of ground water, and uncertainty of rainfall due to global warming and other reasons, it has become very difficult to maintain the urban water supply schemes these days.

### **2.6.1 Quality of Water**

Quality of water is the most important aspect. There are international and national standards for the quality of water to be supplied for human consumption. The state governments may have a slight relaxation in the standards depending upon the local conditions but in general they are the same throughout the country.

The main aim of the public health engineering departments or the environmental engineering departments as they are called these days is to supply safe and palatable (good in taste) water to the consumers. Water should also be free from any odour. The temperature of water should be reasonably good. It should neither be corrosive nor scale forming and should be free from minerals that can produce undesirable physiological effects. For achieving this ideal condition the minimum standards of quality are to be established. The evolution of standards for the control of quality of public water supplies has to consider the limitations imposed by the local factors in the different regions of the country. As per the Manual on Water Supply and Treatment published by the Government of India, the main objective is to make water absolutely free from risks of transmitting disease, means safety is compulsory where as the other qualities are to be maintained within a specified range. For example water may have dissolved solids upto 500 mg per litre but cannot have any bacteria or other micro organism. Actually water is a very good carrier of many diseases producing organisms (pathogens) as there are all chances of its getting contaminated (infected by pathogens). If a small drop of urine or fecal matter (excreta, nightoil) is mixed in a body of water (canal, pond etc.) and the person contributing it has some disease like cholera, gastroenteritis, infectious hepatitis jaundice, typhoid, etc., it will infect the stream. Anybody using that water without treatment (disinfection) is liable to catch the same disease. Sometimes the foul waste water (from latrines, toilets etc.) goes down the earth and gets mixed (at a shallow depth) with the ground water it pollutes it. If this ground water lifted by a hand pump or a tube-well is used again without disinfection it shall cause disease in the person using it. Sometimes the dissolved salts may produce some other diseases like fluorosis (due to excessive fluoride) methemoglobinemia (blue baby disease) due to excessive nitrates in, infants) etc. So water must not have the physical, chemical and bacteriological parameters beyond limits.

(a) The following table shows the physical and chemical standards of water as per the manual.

**Table 2.2 Physical and Chemical Standards**

<b>S. No.</b>	<b>Characteristics</b>	<b>*Acceptable</b>	<b>**Cause for rejection</b>
1	Turbidity (units on J.T.U. Scale)	2.5	10
2	Colour (Units on platinum Cobalt Scale)	5.0	25
3	Taste and Odour	Unobjectionable	Unobjectionable
4	pH	7.0 to 8.5	6.5 to 9.2
5	Total dissolved solids(mg/l)	500	1500
6	Total hardness (mg/l)(as CaCO <sub>3</sub> )	200	600
7	Chlorides as Cl (mg/l)	200	1000
8	Sulphates (as SO <sub>4</sub> ) (mg/l)	200	400
9	Fluorides (as F) (mg/l)	1.0	1.5
10	Nitrates (as NO <sub>3</sub> ) (mg/l)	45	45
11	Calcium (as Ca) (mg/l)	75	200
12	Magnesium (as Mg) (mg/l)	30	150
13	Iron (as Fe) (mg/l)	0.1	1.0
14	Manganese as Mn (mg/l)	0.05	0.5
15	Copper (as Cu) (mg/l)	0.05	1.5
16	Zinc as Zn (mg/l)	5	15
17	Phenolic Compounds (as Phenol) mg/l	0.001	0.002
18	Anionic detergents (as MBAS) (mg/l)	0.2	1.0
19	Mineral Oil (mg/l)	0.01	0.3

**Table 2.3 Toxic Materials**

<b>S. No.</b>	<b>Characteristics</b>	<b>Acceptable</b>	<b>Cause for rejection</b>
1	Arsenic (as As) (mg/l)	0.05	0.05
2	Cadmium (as Cd) (mg/l)	0.01	0.01
3	Chromium (as hexavalent Cr) (mg/l)	0.05	0.05
4	Cyanides (as CN) (mg/l)	0.05	0.05
5	Lead (as Pb) (mg/l)	0.1	0.1
6	Selenium (as Se) (mg/l)	0.01	0.01
7	Mercury (total as Hg) (mg/l)	0.001	0.001
8	Polynuclear aromatic hydrocarbons (PAH)	0.2m g/l	0.2m g/l

Contd....

Radio Activity			
1	Gross Alpha activity	3 pico curie/l	3 pico curie/l
2	Gross Beta activity	30 pico curie/l	30 pico curie/l

Notes \*The figures indicated under the column 'acceptable' are the limits upto which the water is generally acceptable to the consumer.

\*\*Figures in excess of those mentioned under "acceptable' render the water not acceptable, but still may be tolerated in the absence of alternative and better source but upto the limits indicated under column "cause for rejection" above which the supply will have to be rejected.

It is possible that some mine and spring water may exceed these radio activity limits and in such case it is necessary to analyze the individual radionuclides in order to assess the acceptability or otherwise for public consumption.

### **(b) Bacteriological Standards**

#### **(i) Water entering the distribution system:-**

Coliform (bacteria, as the indicator organism) count in any sample of 100 ml water should be zero. A sample of the water entering the distribution system that does not conform to this standard calls for an immediate investigation into both the efficacy of the purification process and the method of sampling.

#### **(ii) Water in the distribution system shall satisfy all the three criteria indicated below:-**

- E. Coli (Escherichia Coli, bacteria found in the colon of human beings as a natural habitant) count in 100 ml of any sample should be zero.
- Coliform organisms (group of B- Coli bacteria coli and E. Coli) , not more than 10 per 100 ml shall be present in any sample.
- Coliform organisms should not be detectable in 100 ml of any two consecutive sample or more than 5% of the samples collected for the year.

If coliform organisms are found, re-sampling should be done. The repeated findings of 1 to 10 coliform organisms in 100 ml or the appearance of higher numbers in any sample should necessitate the investigation and removal of the source of pollution.

#### **(iii) Individual or small community supplies**

E.coli count should be zero in any sample of 100 ml and coliform organisms should not be more than 3 per 100 ml. ( If repeated samples show the presence of coliform organisms, steps should be taken to discover and remove the source of pollution. If coliform exceeds 3 per 100 ml, the supply should be disinfected).

(c) ***Virological Aspects***

0.5 mg/l of free chlorine residual for one hour is sufficient to inactivate virus, even in water that was originally polluted. This free chlorine residual is to be insisted in all disinfected supplies in areas suspected of endemicity of infectious hepatitis Jaundice to take care of the safety of the supply from virus point of view which incidentally takes care of the safety from the bacteriological point of view as well. For other areas 0.2 mg/l of free chlorine residual for half an hour should be insisted.

### 2.6.2 Characteristics of Water

To ensure the quality of safe drinking water (potable water) the water is to be tested for its physical, chemical and bacteriological characteristics.

(a) ***Physical Characteristics:***

- (i) **Temperature:** It can be measured by a thermometer. The temperature should be suitable to the human beings depending upon the climatic and weather conditions. An average temperature of 15°C is generally suitable.
- (ii) **Turbidity:** The muddy or cloudy appearance of clay or such other particles that presents hindrance to the path of light is known as turbidity. It may not be harmful but even then from aesthetical point of view it should not exceed the allowable value. The turbidity is measured by a turbidity rod or a turbidity meter with physical observations and is expressed as the suspended matter in mg/l or ppm (part per million). The standard unit of turbidity is that which is produced by 1 mg of finely divided silica in one litre of distilled water. The turbidity in excess of 5 mg/l is detectable by the consumer and is hence objectionable. It is measured in the laboratory by **Jackson , Baylis** or such other turbidimeters.
- (iii) **Colour:** The colour is imparted by dissolved organic matters from decaying vegetation or some inorganic materials such as coloured soils (red soil) etc. The algae or other aquatic plants may also impart colour. Again it is more objectionable from aesthetics point of view than the health. The standard unit of colour is that which is produced by one milligram of platinum cobalt dissolved in one liter of distilled water. Colour is measured in the labs by **Nessler's tubes** by comparing the sample with the known colour intensities. More precisely tintometer measures it.
- (iv) **Taste and odour:** The dissolved inorganic salts or organic matter or the dissolved gases may impart taste and odour to the water. The water must not contain any undesirable or objectionable taste or odour. The extent of taste or odour is measured by a term called odour intensity which is related with threshold odour, which represents the dilution ratio at which the odour is



hardly detectible. The water to be tested is gradually diluted with odour free water and the mixture at which the detection of taste and odour is just lost is determined. The number of times the sample is diluted is known as the threshold number. Thus if 20 ml of water is made 100 ml (until it just loses its taste or odour) then the threshold number is 5. For domestic water supplies the water should be free from any taste and odour so the threshold number should be 1 and should not exceed 3.

- (v) **Specific conductivity of water:** The specific conductivity of water is determined by means of a portable dionic water tester and is expressed as micro-mhos per cm at 25°C. Mho is the unit of conductivity and is equal to 1 amper/1 volt). The specific conductivity is multiplied by a co-efficient (generally 0.65) so as to directly obtain the dissolved salt content in ppm..

### (b) Chemical Characteristics

Chemical analysis of water is done to determine the chemical characteristics of water. This involves the determination of total solids, suspended solids, pH value, hardness, chlorides, nitrogen content, iron, manganese and other contents, dissolved gases etc.

- (i) **Total solids and suspended solids:** The total amount of solids can be determined by evaporating a measured sample of water and weighing the dry residue left. The suspended solids can be determined by filtering the water sample and weighing the residue left on the filter paper. The difference between the total solids and the suspended solids will be the dissolved solids.
- (ii) **pH of water:** pH is the negative logarithm of hydrogen ion concentration present in water. The higher values of pH mean lower hydrogen ion concentrations and thus represent alkaline water and vice versa. The neutral water has same number of H<sup>+</sup> and OH<sup>-</sup> ions. The concentration of both ions in neutral water is 10<sup>-7</sup> moles per liter. The neutral water will therefore possess a pH equal to

$$\log_{10} (1/H^+) = \log_{10} (1/10^{-7}) = \log_{10} 10^7 = 7$$

If an acid is added to neutral water the number of hydrogen ion increases and thus the pH reduces. Similarly, if an alkali is added the number of hydroxyl ion increases thus reducing the hydrogen ion (as their product is constant, = 10<sup>-14</sup> mole/liter) and the pH increases.

Hence, if the pH of water is more than 7 it is alkaline and if it is less than 7 it is acidic. Generally, the alkalinity in water is caused by the presence of bicarbonates of calcium and magnesium, or by the carbonates or hydroxides of sodium potassium calcium and magnesium. Some of the compounds which cause alkalinity also cause hardness. Acidity is caused by the presence of mineral acids, free carbon dioxide, sulphates of iron and aluminium etc.



The pH value can be measured by a digital pH meter. It can also be measured with the help of colour indicators. The indicators are added to sample of water and the colour produced is compared with the standard colours of known pH values.

For municipal water supplies the pH should be as close to 7 as possible. The lower pH water (acidic) may harm the pipe lines etc. by reacting with them (tuberculation and corrosion). The alkaline water may produce sedimentation, (scaling) in pipes, difficulties in chlorination ( for disinfection) and adverse effect on human physiological system.

- (iii) **Hardness of water:** Hardness in water prevents the formation of sufficient foam when used with soap. It is caused by certain dissolved salts of calcium and magnesium which form scum with soap and reduce the formation of foam which helps in removing the dirt from clothes. These salts keep on depositing on the surface of boilers and thus form a layer known as scale which reduces the efficiency of the boilers. The hardness is known as temporary hardness if it is due to the bicarbonates of calcium and magnesium as this can be easily removed by boiling water or adding lime to it. By boiling the carbon dioxide gas escapes and the insoluble carbonates are deposited (which cause scaling). If sulphates, chlorides and nitrates are present they cannot be easily removed by boiling and so such water requires water softening methods and this type of hardness is known as permanent hardness. Hardness is measured by titration method (E.D.T.A. method) and is expressed in ppm or mg/l. Generally the underground water is more hard as it dissolves the salts in its journey from surface to the ground water table. For boiler feed waters and for efficient washing of clothes the water must be soft i.e. hardness should be less than 75 ppm(mg/l).
- (iv) **Chlorides:** Chlorides are generally present in water in the form of sodium chloride and their concentration above 250 mg/l produces a salty taste in drinking water. The chlorides can be measured in water by titrating the water with standard silver nitrate solution using potassium chromate as indicator.
- (v) **Nitrogen content:** The nitrogen in water may occur in one or more forms of the following:
- (a) Free ammonia
  - (b) Albuminoid nitrogen
  - (c) Nitrites
  - (d) Nitrates

The free ammonia indicates very fast stage of decomposition of organic matter (thus indicating fresh pollution); albuminoid nitrogen represents the quantity

of nitrogen present in water before the decomposition of organic matter has started, the nitrites indicate the partly decomposed organic matter (the continuation of decomposition) and the nitrates indicate the presence of fully oxidized organic matter (means the prior pollution condition). In potable water the free ammonia (undecomposed organic matter should not be more than 0.15 ppm, and the albuminoidal nitrogen should not be more than 0.3 ppm. The nitrogen may remain in the form of nitrates but that too should not be more than 45 ppm as a higher concentration causes blue baby disease in the infants. Actually the nitrates act with the haemoglobin in the blood (which imparts red colour) and reduce it thus converting the colour of skin to blue (impure blood) and thus making them ill and in extreme cases they can die. Nitrate is measured either by reduction to ammonia or by matching the colours produced with phenoldisulphonic acid.

- (vi) **Metals and other chemical substances:** Various metals and minerals may be present in water like iron, manganese, copper, lead, cadmium, arsenic, barium, selenium, etc. The allowable limits for them are as shown in the above tables. If the concentration of these metals and minerals exceeds the permissible limits they have certain harmful effects on the human health.

Higher concentrations of iron and manganese may cause discoloration of clothes washed in such waters. They may cause incrustation in water supply pipe lines due to deposition of ferric hydroxide and manganese oxide. Lead and barium salts are toxic and thus very low concentration of these salts is permissible. Arsenic is a well known poison and as such extremely low concentration (0.05 ppm) is permitted. Most of the ground water in Punjab is having arsenic more than the permissible limits because of the industrial waste water pollution. High quantities of copper may badly affect human lungs and other respiratory organs.

- (vii) **Dissolved gases:** Various gases like  $\text{CO}_2$ ,  $\text{O}_2$ ,  $\text{N}_2$ ,  $\text{H}_2\text{S}$  and  $\text{CH}_4$  etc. may be present in dissolved form in water.  $\text{H}_2\text{S}$  even in small concentration gives bad taste and odour.  $\text{CO}_2$  indicates biological activity. Oxygen is generally absorbed by water from the atmosphere. Its saturation concentration depends upon temperature. The organic matter may be present in water due to the disposal of waste water in it. Organic matter is instable and has a tendency to become stable i.e. to be inorganic matter. This conversion is known as decomposition of organic matter and the process is bio-chemical. As it takes place by bacteria (bio means living) and the conversion is extra cellular enzymatic reaction so it is known as a bio-chemical reaction. The demand of oxygen imposed by the aerobic (working in presence of oxygen) bacteria is known as the Bio Chemical Oxygen Demand (BOD). This BOD reduces the dissolved oxygen content of the water. So if the DO of water is found to be

less than the concentration DO it indicates the water pollution. The BOD of treated water should be nil.

After knowing the standards of potable water one should know the ways and means to make the water fit for drinking, i.e. the treatment of water.

## 2.7 TREATMENT OF WATER

The available raw water has to be treated to make it fit, i.e. potable, means safe for human consumption. It should satisfy the physical, chemical and bacteriological standards as specified above. The various methods of purification of water are

- (i) Screening
- (ii) Plain sedimentation
- (iii) Sedimentation aided with coagulation
- (iv) Filtration
- (v) Disinfection
- (vi) Aeration
- (vii) Softening
- (viii) Miscellaneous treatments like defluoridation, recarbonation desalination etc.

### 2.7.1 Screening

Screens are provided before the intake works so as to prevent the entry of big objects like debris, branches of trees, part of animals etc. Screens may be of two types, coarse screen and fine screens. Coarse screens are parallel iron rods placed vertically or at a small slope at about 2.5 cm to 10 cm apart. The fine screens are made up of fine wire or perforated metal with small openings less than 1 cm size. Finer is the screen more are the chances of clogging so generally only coarse screens are used. The screens may be manually cleaned or mechanically cleaned depending upon the requirement i.e. the size of the treatment plant.

### 2.7.2 Plain Sedimentation

Sedimentation is done to remove the impurities which have specific gravity more than that of water and are settleable. When water is moving these impurities remain in suspension due to the turbulence and as the velocity is reduced they settle down. It is not necessary to stop the motion of water completely as it will require more volume of the sedimentation tanks. As per the theory of sedimentation the settlement of a particle depend upon the velocity of flow, the viscosity of water, the size shape and specific gravity of particle. The settling velocity of a spherical particle is expressed by Stoke's law which gives the final equation as follows,

$$V_s = \frac{g}{18} (S_s - 1) \frac{d^2}{\nu}$$

Where

$V_s$  = Velocity of settlement of particle in m/sec

$d$  = diameter of the particle in cm

$S_s$  = specific gravity of the particle

$\nu$  = kinematic viscosity of water in  $m^2/sec$

Knowing the settling velocity of particle, that is intended to be settled, the design of the settling tank is done.

### 2.7.3 Sedimentation Aided with Coagulation

The fine suspended particles like mud particles and the colloidal matter present in water cannot settle down by plain sedimentation with ordinary (lesser) detention periods. Some of the colloidal impurities will not settle even if the water is detained for long periods in the sedimentation tanks as the same charge on the clay particles repel each other and do not allow them to settle down. So the sedimentation is aided with coagulation. Coagulation is a process in which some chemical like alum or ferrous sulphate is mixed in water resulting in particle destabilization. Operationally this is achieved by the addition of appropriate chemical like alum and intense mixing for achieving uniform dispersion of the chemical. These chemicals are more effective when the water is slightly alkaline. Sometimes sodium carbonate or lime is to be added to achieve the suitable pH of water. Flocculation is the second stage of the formation of settleable particles (or flocs) from destabilized (neutral) colloidal particles and is achieved by gentle (slow) mixing. So in flocculation the alum is first mixed rapidly for dispersion and then slow mixing produces flocks. Both these stages of flocculation are greatly influenced by physical and chemical forces such as electrical charge on particles, exchange capacity, particle size and concentration, pH, water temperature and electrolyte concentration.

### 2.7.4 Filtration

Filtration is a physical and chemical process for separating suspended and colloidal impurities from water by passage through a porous bed made up of gravel and sand etc. Actually the sedimentation even aided with coagulation and flocculation cannot remove all the suspended and colloidal impurities and to make water (specially surface water) fit for drinking filtration is a must. The theory of filtration includes the following actions:

- Mechanical straining, the suspended particles present in water that are of bigger size than the voids in the sand layers are retained their itself and the water becomes free of them. The sand layer may get choked after some time and then it is to be cleaned for further action by washing it back.
- Sedimentation, the small voids in the sand act as tiny sedimentation tanks and the colloidal matter arrested in these voids is a gelatinous mass and thus attracts other finer particles. These finer particles are thus removed by the sedimentation.

- Biological metabolism, certain micro-organisms are present in the sand voids. They decompose the organic matter like the algae etc. and thus remove some of the impurity.
- Electrolytic change, according to the theory of ionization a filter helps in purifying the water by changing the chemical characteristics of water. The sand grains of the filter media and the impurities in water carry electrical charge of opposite nature which neutralizes each other and forces the particles to settle now by gravity.

### 2.7.5 Disinfection

The filtration of water removes the suspended impurities and removes a large percentage of bacteria but still some of the bacteria remain there in the filtered water. This bacteria may be harmful bacteria (disease producing bacteria) known as pathogenic bacteria. The process of killing these bacteria is known as disinfection. There are many diseases like cholera, gastro entities, infectious hepatitis (jaundice), typhoid etc., the bacteria or virus of which transmits through water. It is necessary to make water free from any micro-organism before human consumption. Contamination (mixing of pathogenic micro-organism) may take place in the water supply at any time (because of leakage etc.) so proper measures must be taken to stop it at all levels. Generally the disinfection is done by adding chlorine to water. There should be a residual amount of chlorine after the disinfection to fight with any probable contamination in the route of water to the consumer. Following are some of the methods of disinfection

- Boiling of water
- Treatment with excess lime
- Use of ozone
- Treatment with ultraviolet rays
- Use of potassium permanganate
- Treatment with silver
- Use of bromine, iodine and chlorine

Out of the above, treatment with chlorine is the most popular and economically effective. Actually the criteria for a good disinfectant as per the Manual are,

- It should be capable of destroying the pathogenic organisms present, within the contact time available and not unduly influenced by the range of physical and chemical properties of water encountered particularly temperature, pH and mineral constituents.
- It should not leave products of reaction which render the water toxic or impart colour or otherwise make it unpotable.
- It should have ready and dependable availability at reasonable cost permitting convenient, safe and accurate application to water.

- It should possess the property of leaving residual concentrations to deal with small possible recontamination.
- It should be amenable to detection by practical, rapid and simple analytical techniques in the small concentration ranges to permit the control of efficiency of the disinfection process.

The factors affecting the efficiency of disinfection are

- Type, condition and concentration of organisms to be destroyed
- Type and concentration of disinfectant
- Contact time and concentration of disinfectants in water and
- Chemical and physical characteristics of water to be treated particularly the temperature, pH and mineral constituents.

Potable water should always have some amount of **residual chlorine**, as there are all chances of contamination at all levels. This may be 0.2 ppm. to 0.3 ppm. depending upon the requirement (rainy season or enhanced chances, more  $\text{Cl}_2$  required). To make sure the presence of chlorine some tests are done out of which Orthotolidine test is the most common one.

**Orthotolidine Test:** In this test 10 ml of chlorinated sample of water is taken after the required contact period (say half an hour) in a glass tube. 0.1 ml of orthotolidine solution is added to it. The colour formed is noted after 5 minutes and compared with the standard coloured glasses. Darker is the yellow colour formed more is the residual chlorine. The test is very simple and even a semi- skilled employee can perform it satisfactorily and it can be done at the site itself and accordingly corrective measures can be taken. For example if there is a complaint from a hostel mess. Test is performed for the tank water and if no residual chlorine is found, bleaching powder (a good source of chlorine) is mixed with some water and added to the tank water in paste form and stirred. The test is again performed after half an hour till it shows the required residual chlorine.

### 2.7.6 Aeration

Taste and odour, both are undesirable in water. Aeration is done to remove taste and odour. Aeration is done to promote the exchange of gases between the water and the atmosphere. In the water treatment, aeration is performed for the following purposes,

- To add oxygen to water for imparting freshness, for example water from underground sources may have lesser oxygen.
- For expulsion of carbon dioxide, hydrogen sulphide and other volatile substances causing taste and odour.
- To precipitate impurities like iron and manganese specially from underground water.

In aeration gases are dissolved in or liberated from water until the concentration of the gas in the water has reached its saturation value. The concentration of gases

in a liquid generally obeys Henry's law which states that the concentration of each gas in water is directly proportional to the partial pressure (product of the volume percentage of the gas and the total pressure of the atmosphere.) or concentration of gas in the atmosphere in contact with water. The saturation concentration of a gas decreases with temperature and dissolved salts in water. Aeration accelerates the exchange of gas. To ensure proper aeration it is necessary to,

- Increase the area of water in contact with the air. The smaller are the droplets produced the larger will be the area available.
- Keep the surface of the liquid constantly agitated so as to reduce the thickness of the liquid film which would govern the resistance offered to the rate of exchange of the gas.
- Increase the time of contact of water droplets with air or increase the time of flow which can be achieved by increasing the height of jet in spray aerators and increasing the height of tower in case of packed media.

Where oxygen is to be dissolved in water, the concentration or partial pressure of the oxygen may be increased by increasing the total pressure of the gas in contact with water. For this purpose air injected into a main under pressure is a reasonably efficient method of increasing the amount of dissolved oxygen.

### 2.7.7 Water Softening

The reduction or removal of hardness from water is called as water softening. For domestic water supplies the softening is done to reduce the soap consumption, to ensure longer life to washed fabric, to lower the cost of maintaining plumbing fixtures and to improve the taste of food preparations and improve palatability (good taste). For industrial supplies softening is done for reducing scaling problems in boilers and the interference in the working of dyeing systems. Usually a total hardness of 75 to 100 mg/l (as  $\text{CaCO}_3$ ) would meet these requirements. The magnesium hardness should not exceed 40 mg/l to minimize the possibility of magnesium hydroxide scale in domestic water heaters. Calcium and magnesium associated with bicarbonates are responsible for carbonate hardness and that with the sulphates, chlorides and nitrates contribute to non carbonate hardness. Normally the alkalinity measures the carbonate hardness unless it contains sodium alkalinity. The non carbonate hardness is measured by the difference between the total hardness and the carbonate hardness. Carbonates and bicarbonates of sodium are described as negative non carbonate hardness.

The temporary hardness or bicarbonate hardness can be removed by boiling or by adding lime. The following reactions take place by boiling:

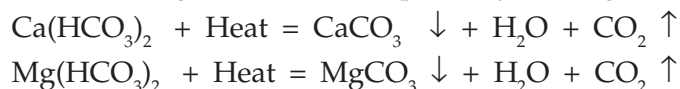

As it is difficult to boil the water at large scale the addition of lime is done. The following reaction takes place when lime is added to water,



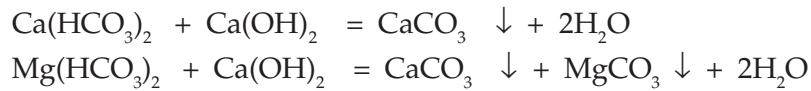

The carbonates of calcium and magnesium are removed by sedimentation being insoluble in water.

The permanent hardness is removed by:

- (i) Lime-soda process
- (ii) Zeolite process
- (iii) Demineralization or deionization process.

### Lime-soda process

In the lime soda process lime and soda ash ( $\text{Na}_2\text{CO}_3$ ) are added which removes both the temporary and permanent hardness.

The additional reactions with soda are as follows

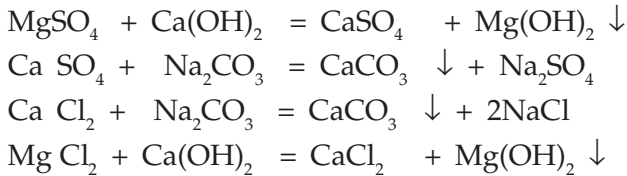

Using the above reactions the hardness is removed in the lime soda plants

### Zeolite process

The lime soda method is a precipitation method in which some chemicals or reagents are added to the water. In the zeolite process no such chemical is added and the hard water is passed through a bed of special material called as the zeolite. The zeolite has the property of removing calcium and magnesium from the water and substituting sodium in their place by ion exchange phenomenon. Zeolites are complex compounds of aluminum, silica and soda, some times synthetic and otherwise natural. Natural zeolites are mainly processed from green sand (glaucanite). It has an exchange value of about 8000 gm of hardness per  $\text{m}^3$  of zeolite. The common artificial zeolite is permutit. It has larger grains with white colour. Permutit ( $\text{SiO}_2 \text{ Al}_2\text{O}_3 \text{ Na}_2\text{O}$ ) has a high exchange value of 35000 to 40000 gm of hardness per  $\text{m}^3$  of zeolite.

When hard water passes through a bed of permutit the following reactions take place

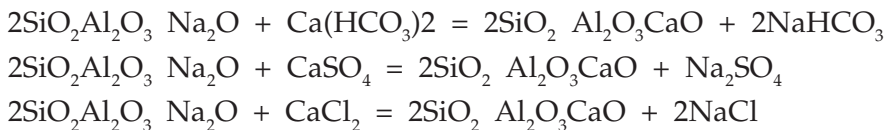

Similar reactions take place with compounds of magnesium hardness can be reduced to almost zero by this method. Due to continuous use of the zeolite the sodium gets exhausted and then the zeolite has to be regenerated by passing a solution of salt through it. The sodium in the brine (salt water) replaces the calcium and magnesium



in the exhausted zeolite which is thus restored and the calcium and magnesium are discharged to waste with the wash water.

### ***Demineralization or deionisation process***

The conventional zeolites exchange the sodium cations (positive in electric charge) for the cations of calcium magnesium and iron in water and the softening is essentially a cation exchange process. In the demineralization or deionisation process, some other zeolite is used which exchanges all the cations (including sodium) for hydrogen. Some of the zeolites are patented as zeo-karbs, catex organolites etc. are carbonaceous zeolites since they are made from materials like coal and lignite. They are also known as hydrogen exchanger. The water treated with hydrogen zeolite has the sulphates, chlorides and bicarbonates transformed into sulphuric, hydrochloric and carbonic acids.

Actually the demineralization is done mainly to make the brackish water (as sea water) useful for drinking. It is a costly process.

## **2.8 REQUIREMENT OF PRESSURE OF WATER TO BE SUPPLIED**

After the treatment the water is supplied to the consumers through the distribution system. This includes the collection of treated water in the clear water reservoir, pumping it to the overhead reservoirs (over head tanks) and then distribution through the pipeline network. The network is designed in such a way that the water reaches to all the consumers with a minimum pressure of 7 meters for single storied and 12 meters for double storied buildings. The distribution system is designed by Hardy Cross method of balancing flows or other methods like equivalent pipe method etc. The minimum pipe sizes of 100 mm for towns having population upto 50000 and 150 mm pipes for those above 50,000 are recommended.

The supply from the street main to the individual buildings is made through a house service connection. The water is used in the house premises for many purposes like drinking, cooking, bathing, cleaning of utensils, floors and clothes etc., gardening and flushing. The water is also used for commercial and industrial purposes. The total per capita water demand of a city depends on many factors like the size of the city, climatic conditions, living standards, mode of supply, mode of assessment etc. In general the following rates per capita per day are considered minimum for domestic and non domestic needs as per the manual on water supply & Treatment.

- |  |                    |
|--|--------------------|
| (i) for communities with population upto 10000           | 70 to 100 litres   |
| (ii) for communities with population upto 10000 to 50000 | 100 to 125 litres  |
| (iii) for communities with population above 50000        | 125 to 200 litres. |

Approximately 80% of this water comes out as the domestic wastewater also known as sewage. Waste is actually a misplaced resource. The term wastewater means a type of water that cannot be further used for the same purpose again. The wastewater of a process can be used as influent for the other process. For example the domestic

wastewater may be used for irrigation or the wastewater from kitchens and bathrooms (non foul) may be used for flushing and gardening in the same premises. The collection conveyance, treatment and disposal of the wastewater is known as the wastewater management.

## **2.9 WASTE WATER MANAGEMENT**

As per the Manual on Sewerage and Sewage treatment the Government of India publication, in India, wastewater disposal systems are usually managed by local bodies. This service facility falls under the water supply and sanitation sector. The development of the sector is assisted at Government of India level, State Government level and local body level. There are five basic important aspects of the wastewater management namely,

- (i) General Administration
- (ii) Personnel Administration
- (iii) Inventory Control
- (iv) Financial Control
- (v) Public Relation

For proper maintenance of data, review, follow up and decision making, software programmes developed by the Central Public Health Environmental Engineering Organization (CPHEEO) under Management Information System can be profitably used.

The wastewater management system in general should aim at the following achievement.

- (a) Proper collection of wastewater discharged by the community.
- (b) Adequate treatment of wastewater to achieve the desired effluent standards.
- (c) Safe and efficient operations and as far as possible self supporting.
- (d) Sound financial management.

### **2.9.1 Prevention of Pollution**

As per the manual, the early law regulating pollution was enforced almost entirely through the process of individual suits for what was termed a private nuisance. The concept of public nuisance has also been used to some degree to control pollution. A public nuisance is an act which causes inconvenience or damage to the public as distinguished from one or a few individuals and includes any interference with the public health, safety, or inconvenience. A public nuisance is subject to abatement at the behest of state officials. It may also constitute a crime.

In our country until recently the pollution was regulated through state factory acts and rules also by some sections (section 28) of the Indian Easement Act. As the scope of these acts is limited in its extent and does not provide much guidance in respect of water pollution prevention, the union government enacted the water (Prevention and

Control of Pollution) Act, in 1974, which is applicable to all union territories and has been adopted by all the states, by resolution passed in that behalf under clause (i) of article 252 of the constitution. Under the provision of this Act, no discharge of wastewater can be made in the environment without obtaining consent from the State Pollution Control Board (from the Central Pollution Control Board in case of Union Territories). A consent prescribes the volume and quality of wastewater in terms of concentration of various pollutants which can be permitted for discharge in the environment.

In 1986 the union government enacted the Environment (Protection) Act 1986, for protection and improvement and the prevention of hazard to human beings, other living creatures, plants and property. The Act empowers the Union Government to make rules providing standards in excess of which environment pollutants shall not be discharged or emitted in the environment and to take direct action against defaulters.

### 2.9.2 Statutory Water and Sanitation Boards

As per the manual most of the local bodies at present face serious handicaps in the promotional stages of a project, in its pre financing stage and in the fund raising stage as well. With the responsibilities beyond their capacity and the limitations of finance and procedures, any attempt by them individually to raise loans in the open market to finance a local wastewater disposal project may not attract encouraging response. This problem may be solved by creating autonomous water and sanitation boards. These boards are devices by which the State Government will be able to establish corporate public entities to construct manage and operate water and sanitary services on a fully commercial basis in large metropolitan areas as well as in small urban communities. These boards should be empowered and equipped to raise such capital from local resources and the open market borrowings to supplement the resources provided by the Government at the State and Central level. Such boards may have the advantages of,

- (i) An increased efficiency resulting from financial autonomy.
- (ii) Improved ability to raise capital with confidence.
- (iii) Affording better opportunities for small municipalities grouped together to finance and operate their schemes as a business proposition.
- (iv) The economies implicit in a common authority which may be made to serve several undertakings.
- (v) The economies possible by pooling technical and administrative staff to serve a number of municipalities. And
- (vi) The opportunities for equalizing the rates in every region.

A statutory Water and Sanitation Board may be set up at the state level with regional boards if and to the extent necessary within the state, to provide water and sanitation services and to collect revenues to meet such services, to raise the capital needed to provide the facilities and to exercise all other corporate powers necessary to act on behalf of the local bodies within their jurisdiction. Normally such boards would encompass

all activities including production treatment conveyance and distribution of water within their statutory areas and also for the collection, treatment and disposal of sewage from that area as well as other sanitation services. It is however possible that some local bodies may prefer to purchase water in bulk from the statutory boards and arrange for the internal distribution by themselves and may also prefer to have the statutory board take over sewage in bulk from the local area and arrange for its treatment and disposal. This should be avoided as far as possible as the supply and distribution of water as also collection and disposal of sewage are two interdependent functions and the division of such functions amongst two independent agencies might lead to inefficiency and avoidable difficulties for both parties. Any local body managing its system satisfactorily need not necessarily come under such a board.

### **2.9.3 Waste Water Management**

What so ever may be the agency, the aim of wastewater management is the protection of environment from the ill effects of the wastewater. As stated earlier the wastewater management has the main components as collection, conveyance, treatment and disposal of wastewater. Let us discuss them one by one.

#### **2.9.3.1 Collection of Domestic Wastewater**

The wastewater is generated from many activities in the house premises. The water that comes out from the kitchen after cleaning the utensils etc. contains the residuals of washing powder and oil, food particles etc. The water which comes out from bathrooms also contains soap detergents dust, dirt etc. As both of them does not include urine and fecal matter (human excreta, nightsoil) so termed as non foul wastewater. The water that carries excreta alongwith it, i.e. from the water closets is known as foul wastewater. Actually these days the bathrooms and WCs are constructed in a single unit known as the toilet, so wastewater from a toilet is foul wastewater. The term foul here means the readily biodegradable matter. The nightsoil and other such organic matter starts quickly degrading and as such produce bad smell and pollutes the environment so they are known as foul matters. Earlier these two types of wastewaters were dealt separately but these days there is no distinction in their handling.

However, the type of traps, used in their collection are different. Trap is a bent piece of pipe specially designed to keep (trap) some water always in it that prevents the entry of bad smell (foul gases) into the premises from the pipes and the other components of the collection system. Depending upon their particular shapes and the uses the traps are known as P, Q, S, and Gulley trap, Nahani trap or the intercepting traps. The traps are attached to the WC pans or the bottom of the kitchen sinks or the washbasins. The WC pans are mainly of two types, Indian (used in squatting position) or European (used in sitting position). Wastewater comes out of the trap by some force of the flushing action or the head of the washbasin and travels through the house drain pipeline to the inspection chamber. Earlier the drainpipes were made up of stoneware china clay

but these days they are plastic pipes. The minimum diameter should be 100 mm. The inspection chambers are rectangular small chambers made at every change in alignment, diameter of pipe or mainly at the junction of two pipes. They help in removing the choking of pipes by providing an end to insert some bamboo stick or wire.

### **2.9.3.2 Conveyance or Transportation of Waste Water**

The domestic waste water is carried from the last inspection chamber to the main sewer line laid in the street by the government departments like the Public Health Engineering Department of the State, or the local bodies like the municipality or the development authorities. A manhole is provided on the connection of these pipelines. Manhole is a chamber of masonry covered with a manhole cover of cast iron or concrete provided for the inspection and cleaning of the sewer line. Sufficient space should be there for a person to enter inside it and work for cleaning of the chamber and the sewer line. Manholes are provided at every junction of two lines, change in diameter, change in alignment and slope and also on the straight reaches at some distance that depends upon the diameter of the sewer line. As per the manual, on sewers which are to be cleaned manually, which cannot be entered for cleaning or inspections, the maximum distance between the manholes should be 30 m. The spacing of manholes on large sewers above 900 mm diameter is governed by the following for the sewers to be cleaned manually,

- (a) The distance upto which silt or other obstruction may have to be conveyed along the sewer to the nearest manhole for removal.
- (b) The distance upto which materials for repairs may be conveyed through the sewer and
- (c) Ventilation requirements for men working in the sewer.

For sewers which are to be cleaned with mechanical devices, the spacing of manholes will depend upon the type of equipment to be used for sewer cleaning. The spacing of manholes above 90 to 150 m. may be allowed on straight runs for sewers of diameter 900 to 1500 mm. Spacing of manhole at 150 to 200 m may be allowed on straight runs for sewers of 1.5 to 2 m diameter, which may further be increased upto 300 m for sewers of over 2 m diameter.

Sometimes when a main sewer line receives a small (lateral) sewer line at different levels a drop manhole is provided. If the difference is more than 600 mm the smaller sewer line is bent to come down at the level of the main line so that the sewage does not fall on a worker, cleaning the sewer line.

The sewage is carried away further by the sewer line designed for the same.

### **2.9.3.3 Design of the Sewer Line**

The sewerage system may be designed to carry the sewage alone or the rain water and the sewage both in the same sewer line. For the estimation of storm (rain water) runoff the Rational Method is commonly used. The entire precipitation over the drainage area

does not reach the sewer. The characteristics of the drainage district, such as, imperviousness, topography including depressions and water pockets, shape of the drainage basin and duration of the precipitation determine the fraction of the total precipitation which will reach the sewer. This fraction is known as the co-efficient of runoff need to be determined for each drainage district. The runoff reaching the sewer is given by the expression, as per the manual on Sewerage and Sewage Treatment

$$Q = 10 C i A$$

Where Q is the runoff in m<sup>3</sup> per hour

'C' is the co-efficient of runoff

i, is the intensity of rainfall in mm/hr and

'A' is the area of drainage district in hectares (one hectare = 100 m × 100 m)

For the determination of the intensity of rainfall first of all the storm frequency is fixed depending upon the importance of the area. For example the frequency of flooding of the periphery of a residential area may be twice a year whereas for the commercial and high priced area it is once in two years. Then for this design period the design rainfall intensity is calculated with the help of the rainfall data available. In Indian conditions intensity of rainfall adopted in design is usually in the range of 12 mm/hr to 20 mm/hr.

The co-efficient of runoff depends upon the imperviousness of the drainage area, tributary area, duration of storm etc. Its value may be from 0.125 to 0.9. Knowing the storm water flow the sewer laid separately for the storm water is designed.

The domestic sewage is estimated as 80% of the water supplied to the consumers. The rest 20% water goes as evaporation from different places like the body of human being or the clothes or the floors or in the gardening. The flow in the sewers varies considerably from hour to hour and also seasonally, but for the purposes of hydraulic design it is the estimated peak flow that is adopted. The peak factor or the ratio of maximum to average flows depend upon contributory population and the following values are recommended by the manual

**Table 2.4 Peak Factor**

<b>Contributory population</b>	<b>Peak factor</b>
Upto 20000	3.0
20000 to 50000	2.5
50000 to 7,50000	2.25
Above 7,50000	2.0

The peak factors also depend upon the density of population, topography of site, hours of water supply and therefore it is desirable to estimate the same in individual case, if required. The minimum flow may vary from 1/3 to 1/2 of average flow. After

calculating the quantity of the domestic sewage the separate sewer line may be designed and it is added to the storm water runoff if there is a combined system.

#### 2.9.3.4 Hydraulics of Sewers

The flow in sewers is assumed to be steady and uniform (not changing with time) for simplicity. Actually at the night time or other lean periods the flow in sewers reduces to a minimum value and as the velocity reduces the deposition of solid material takes place. The sewer should be so designed that at the peak flow this deposited material is washed away and there should not be any final deposition ultimately. Such a velocity is known as the self cleansing velocity. As the sewers always run partially full velocity is little influenced by pipe diameter. Sewers are designed to run part full to maintain a gravity flow and for the addition of some infiltration of rain water or the ground water in some cases. Gases of decomposition also find their space in the empty portion. For the present peak flows upto 30 liters per second the slopes as given below as per the manual may be adopted which would ensure a minimum velocity of 0.6 mps in the early years.

**Table 2.5 Recommended Slopes for Minimum Velocity**

<i>Present peak flow in lps</i>	<i>Slope per 1000</i>
2	6.0
3	4.0
5	3.1
10	2.0
15	1.3
20	1.2
30	1.0

The maximum allowable velocity in a sewer to avoid the erosion of the material is 3.0 mps. Knowing the discharge and the self cleansing velocity the sewer may be designed by Manning's Formula as below

$$V = (1/n) \times R^{2/3} S^{1/2}$$

For circular pipes

$$V = (1/n) (3.968 \times 10^{-3}) D^{2/3} S^{1/2}$$

And

$$Q = (1/n) (3.118 \times 10^{-6}) D^{2/3} S^{1/2}$$

Where

Q = discharge in l.p.s

S = slope or hydraulic gradient

D = internal dia of pipe in mm



R = Hydraulic radius in m

V = Velocity in mps

N = Manning's co-efficient of roughness

The value of manning's co-efficient depends upon the pipe material. For salt glazed stoneware pipes it is 0.012, for cement concrete pipes it is 0.013, for steel pipes it is 0.013 etc.

Knowing the discharge and the manning's co-efficient and the slope the required diameter of the sewer is calculated. If the slope is not given means not pre-decided then assuming the self cleansing velocity, both slope and the diameter are calculated. After this the sewer material like brick, concrete, stoneware or vitrified clay (for house drainage), iron or steel, ductile iron, asbestos cement and plastic pipes, high density polyethylene pipes or glass fibre reinforced plastic pipes are selected depending upon the pressure resistance and the availability of budget. Sewer lines are laid by jointing the pipes so designed and selected by different joints like cast iron detachable joints, socket and spigot joints, coupler joints, sealing chemicals or by welding. The sewerage network so laid conveys the sewage to the treatment plant.

#### 2.9.4 Treatment of Wastewater

The objective of sewage treatment is to make the sewage harmless before it is disposed. The disposal means final laying of sewage on the land or leaving it on land to flow and mix in some body of water like the river or a pond. The sewage has many characteristics like temperature, hydrogen ion concentration (pH), colour and odour, solids, nitrogen, phosphorous, chlorides, bio-chemical oxygen demand (BOD), chemical oxygen demand (COD), and toxic metals etc. Though all of them are important for determination of disposal criteria, BOD is the most important one.

The Bio-chemical oxygen demand (BOD) of sewage or polluted water is the amount of oxygen required for the biological decomposition of biodegradable organic matter under aerobic conditions. Actually the food items, human excreta, urine etc. all these are the organic matters. The organic matter has a tendency of decomposition and it always tends to be converted into the inorganic form that is stable. Higher is this tendency more fast is the decomposition. Readily decomposable organic matter is known as the putrescible matter. The decomposition of organic matter is done by the bacteria, which is available in plenty in the sewage. There are mainly two types of bacteria, one which works in presence of oxygen and the other which can work in absence of oxygen. The former is known as the aerobic bacteria and the later is known as the anaerobic bacteria. The facultative bacteria can work in both conditions. The decomposition of organic matter is done by the extra enzymatic reaction of bacteria. As the agency is living, i.e. bio and the reaction is chemical it is known as the bio-chemical reaction. The bacteria can decompose some of the organic matter, known as



the bio-degradable organic matter. The bacteria require oxygen for its metabolism and that demand of oxygen of the bacteria busy in decomposing the organic matter is known as the bio-chemical oxygen demand.

The carbonaceous portion of the organic matter is first oxidized and then the nitrogenous portion gets stabilized. About 68% of the organic matter (carbonaceous) gets stabilized in the initial 5 days and then the rate of decomposition becomes slower (because of the nitrogenous portion). Although the complete BOD is satisfied in infinite time but a large portion of it is satisfied in 5 days so 5 day BOD determination is popularly done. The general temperature of sewage is 20 degree celsius so it is termed as BOD<sub>5</sub> at 20 degree C as the standard BOD. The BOD satisfaction equation is as follows,

$$Y_t = L (1 - 10^{-K_d t})$$

Where

$$Y_t = \text{BOD at any time } t$$

$$L = \text{initial BOD at time } t = 0$$

$$K_d = \text{deoxygenation co-efficient (function of temperature)}$$

$$K_{dT} = K_{d20} \times 1.047^{T-20}$$

$$T = \text{temperature of the reaction}$$

$$K_{d20} = 0.1 \text{ per day (for normal sewage).}$$

So the BOD<sub>5</sub> determines the strength of the sewage. Higher is the BOD<sub>5</sub> stronger is the sewage. The average value of domestic sewage is 300 parts per million (ppm) or mg/liter. The industrial or commercial sewage has generally more value than this.

The chemical oxygen demand COD is known as the total oxygen demand of the bio degradable and non bio degradable organic matter. Obviously it is more than BOD. The COD can be readily (3-4 hours) measured in the laboratory where as the BOD<sub>5</sub> determination takes 5 days in the laboratory. The COD and BOD ratio for a particular type of wastewater can be predetermined and then for a given sample of wastewater by measuring the COD the BOD can be calculated indirectly. The COD /BOD ratio varies generally from 2.0 to 2.5. Actually, the BOD of the waste decides its foulness or the offensiveness. When wastewater is disposed in the river water it consumes the dissolved oxygen of the river water for the satisfaction of its BOD. This reduces the Dissolved Oxygen (D.O) of the river water. If the D.O goes below 4 p.p.m. almost all the fish and the other aquatic life shall be destroyed. The died fish will become organic matter that will further decompose and put more BOD and ultimately the whole of the DO of the fresh body of water shall be exhausted and it will convert into a polluted stale stinking useless body of water.

If this body of water is a river moving fast with turbulence, it shall absorb more and more oxygen from the atmosphere and shall purify itself after some time and distance. This is known as the self purification of water. But if more and more sewage is mixed in it (in between the self purification reach) it shall never purify itself and

become a polluted body of foul water only. This is the present status of most of our rivers. In spite of many action plans of river protection and purification all the rivers in our country are in a bad position. There are rules and legislations that every industry or municipality should treat (reduce BOD to an allowable limit say 30 p.p.m.) before discharging it into water. But unfortunately this is not followed strictly. This is the duty of environment engineer and every citizen to check that no wastewater should be allowed to be mixed in the rivers or ponds without treatment.

#### **2.9.4.1 Unit Operations and Processes**

The treatment of wastewater is a general term that applies to any operation/process that can reduce the objectionable properties of wastewater and makes it less objectionable. Wastewater treatment is a combination of physical, chemical and biological processes. Unit operations are the methods of treatment in which the application of physical forces predominate while unit processes are those in which the chemical and biological activities are involved. The aim of wastewater treatment works is to produce an acceptable effluent through the available unit operations. Generally the wastewater treatment processes bring about changes in concentration of a specific substance by moving it either into or out of the wastewater itself. This is known as the phase transfer. The main phase transfers are as follows,

- (i) Gas transfer : aeration
- (ii) Ion transfer
  - (a) Chemical coagulation
  - (b) Chemical precipitation
  - (c) Ion exchange
  - (d) Adsorption
- (iii) Solute stabilization
  - (a) Chlorination
  - (b) Liming
  - (c) Recarbonation
  - (d) Break point and super chlorination
- (iv) Solid transfer
  - (a) Straining
  - (b) Sedimentation
  - (c) Floatation
  - (d) Filtration
- (v) Nutrient transfer
- (vi) Solid concentration and stabilization
  - (a) Thickening
  - (b) Centrifuging
  - (c) Chemical conditioning
  - (d) Biological floatation
  - (e) Vacuum filtration
  - (f) Sludge digestion
  - (g) Incineration
  - (h) Wet combustion

The following table shows the application of physical unit operations in wastewater treatment.

**Table 2.6 Application of Physical Unit Operations in Wastewater Treatment**

<b>S. No.</b>	<b>Operation</b>	<b>Application</b>
1	Screening	Removal of floating matter
2	Comminution	Grinding and shredding of big objects
3	Equalization	Equalization of flow and BOD loading
4	Mixing	Mixing of chemical and gases in wastewater and keeping solids in suspension
5	Flocculation	Enlarging small particles
6	Sedimentation	Removal of settleable solids
7	Floatation	Thickening of biological sludge
8	Filtration	Removal of fine material after biological or chemical treatment
9	Micro screening	Removal of algae from stabilization ponds, oxidation ponds effluent

The following table shows the application of chemical unit processes in wastewater treatment.

**Table 2.7 Application of Chemical Unit Processes in Wastewater Treatment**

<b>S. No.</b>	<b>Process</b>	<b>Application</b>
1	Chemical precipitation	Removal of phosphorus and enhancement of suspended solids removal in sedimentation
2	Gas transfer	Addition and removal of gases
3	Adsorption	Removal of organics
4	Disinfection	Killing of disease causing organisms
5	Dechlorination	Removal of chlorine residuals
6	Miscellaneous	Specific wastewater treatments

Biological unit processes are those processes in which the removal of objectionable matter is done by biological activity. In this process the objectives are to coagulate and remove the dissolved or nonsettleable colloidal solids.

Biological processes are differentiated by the oxygen dependence of the micro-organisms responsible for the wastewater treatment as follows,

- (a) *Aerobic processes*: The processes occur in presence of oxygen by the aerobic bacteria. The aerobic processes include the following,
  - (i) Trickling filter (attached growth process)
  - (ii) Activated sludge process with its modifications (suspended growth process)
  - (iii) Aerobic stabilization ponds (oxidation ponds)
  - (iv) Aerated lagoons

- (b) *Anaerobic processes:* The anaerobic processes occur in absence of oxygen by the anaerobic bacteria. The anaerobic processes include the following,
  - (i) Anaerobic sludge digestion
  - (ii) Anaerobic contact process
  - (iii) Anaerobic filters
  - (iv) Anaerobic lagoons or ponds
  - (v) Septic tanks and Imhoff tanks
- (c) *Facultative Process:* The facultative bacteria can act in presence as well as in absence of oxygen.

**2.9.4.2 Methods of Treatment of Wastewater**

The treatment of wastewater is a general term that includes any unit operation or process that can reduce the objectionable properties sewage to make it less offensive (bad, foul). The treatment includes,

- (i) Removal of floating and suspended solid matter
- (ii) Treatment of biodegradable organic matter
- (iii) Disinfection (elimination of pathogenic organisms)

The following table shows the functions and efficiencies of the various treatment units:

**Table 2.8 Functions and Efficiencies of the Various Treatment Units**

<b>S. No.</b>	<b>Desired purification action</b>	<b>Process or unit used</b>	<b>BOD removal (% of initial BOD)</b>	<b>Removal of suspended &amp; dissolved solids (% of original)</b>	<b>Bacteria removal (% of original)</b>	<b>Disposal of residuals</b>
1	Removal of floating materials like rags, plastics, papers etc.	Coarse & fine screens	5-10	2-10	10-20	Screenings disposed off by burial or burning
2	Removal of heavy settleable inorganic solids	Grit chamber	10-20	20-40	10-20	Grit used in filling of low lying area, roads
3	Removal of fats and greases	Floatation units and skimming tanks	20-30	20-40	10-20	Anaerobically digested skimmings are disposed

*Contd...*

4	Removal of large suspended organic matter	(i) Plain sedimentation or (ii) septic tanks	30-35 20-30	60-65 40-60	25-75 25-75	Digested sludge is used as manure Combined sludge digestion & sedimentation. Sludge used as manure & effluent is disposed
5	Removal of fine suspended and dissolved organic matter	High & low rate trickling filters preceded by plain sedimentation or Activated sludge treatment or	60-95 75-95	65-92 85-90	80-85 90-98	Same as above  Same as above
		Oxidation ponds	85-90	85-90	90-98	Sewage irrigation

The various operations and processes indicated above for the treatment of sewage give effluent (treated wastewater) and the sludge (solids separated in semi solid form). The effluent may be directly disposed either in the receiving waters (rivers, ponds) or on land. The sludge is generally first of all treated and then disposed. The aim of processing sludge is to extract water (reduce high volumes) and dispose the dewatered residue through a combination of physical chemical and biological operations. The after dewatering chemical conditioning and thickening the sludge is treated biologically, generally by anaerobic treatment.

### 2.9.5 Anaerobic Digestion

In the anaerobic digestion the sludge is enclosed in a closed tank (in absence of oxygen and sunlight) and left there for the required digestion time at a suitable temperature. Some bacteria in the form of digested sludge are first of all mixed into it, borrowed from some other previously running unit for seeding as we do for making curd out of the milk. The anaerobic bacteria so mixed starts growing at an exponential rate under suitable conditions of temperature, pH and nutrient (organic matter). This happens in two distinct stages, acid fermentation and methane fermentation. In the first stage, acid fermentation stage, hydrolysis and liquefaction of high molecular weight organic compound and conversion to organic acids takes place by the acid forming bacteria. Acetic acid, propionic acid and butyric acids are the common end products. This reduces the pH of the reaction.

The second stage known as methane fermentation is gasification of the organic acids to methane and carbon dioxide by acid splitting methane forming bacteria which requires high pH. So for proper functioning of the process it is necessary to maintain a balance between the two, i.e. maintain the desirable pH and temperature. The anaerobic bacteria are heat loving bacteria, known as mesophilic from 10 to 40 degrees and thermophilic from 45 to 60 degrees. Higher is the temperature lesser is the time required for the completion of the process. It takes 75 days at 10 degrees and 14 days at 55 degrees for the anaerobic digestion so generally the digesters are built under the ground to take advantage of the earth cover. Due to the digestion the organic matter gets split into dirty water known as supernatant liquor, gas known as bio gas and solids as the digested sludge also known as the humus. The digested sludge is a stabilized inorganic matter that can be profitably used as manure. It contains the nutrients like N, P, and K, as well as the other micronutrient that are very much desirable for us. The micronutrient like iron, copper etc. gives us strength to fight against the diseases and also increase the taste of food. The biogas so evolved is a combination of methane (60 to 70%) and carbon dioxide (25 to 35%). Methane is a combustible gas with high calorific value so it is used as a cooking gas. Like this the anaerobic digestion of sludge yields in useful end products and helps in reducing the volume of the sludge and thus facilitates the safe disposal of it that was our main aim.

#### 2.9.6 Disposal of Treated Wastewater (Effluent)

The effluent coming out of the sewage treatment plants may be discharged either in receiving bodies of water like streams, ponds, rivers or on land. The type and degree of treatment given to the sewage is dependent upon the requirements imposed by the regulatory authorities like the pollution control boards. The water content of the sewage and the fertility value of the nutrients make it useful for irrigation and pisciculture (fish farming). The effluent can also be used in low-grade industrial uses or for artificial recharging of aquifers (water bearing stratum). The cost of land, public health impact, energy requirement, aesthetics and biological effects decide the mode of disposal whether on land or in water. Here lies the importance of decision making by the environmental engineers and the local bodies. If the wastewater is disposed without treatment into a river it pollutes it badly mainly by decreasing its dissolved oxygen content. Though the river has a capacity of self purification but that depends upon the discharge and the total organic load of the wastewater i.e. its volume and the BOD. The deficiency of the dissolved oxygen in the fresh water caused by the BOD of the wastewater is recuperated by the diffusion of atmospheric oxygen the rate of which depends upon the turbulence etc. The raw (untreated) sewage, full of organic matter increases the growth of unwanted aquatic plants in such a way that the whole body of stagnant water is covered by it. For example the water hyacinth cover the whole lake in a couple of days if the domestic sewage is disposed in it. This is known as **Eutrophication** of lakes. This hampers the penetration of sunrays and thus hinders the production of oxygen by the aquatic plants like algae. It also obstructs the navigation in the water body.

Actually to keep the water oligotrophic (clean) there should be equilibrium between photosynthesis (cell formation) and respiration (cell decay). If the cell decay is more than the cell formation the excessive nutrients supplied by the sewage get accumulated which in turn stimulates bacterial activity. When there is excess supply of sewage in lake water it results in accumulation of organic matter and the lake becomes **Eutrophic**. This accumulation of organic substances increases the oxygen demand (BOD) of the water enormously which leads to anaerobic decay and the lake gets filled up by the decayed matter. If the cell formation is more than the respiration or decay excessive inorganic nutrients accumulate due to mineralisation. The acute response of algae to the nutrients results in growth of both prokaryotic and eukaryotic species leading to removal of CO<sub>2</sub> at such a rate that the lake becomes alkaline. This increases the growth of blue-green algae that not only fix nitrogen but limit the potential resources of the herbivores and eliminate better species of fishes. In eutrophic state the water becomes foul smelling, hard with very low oxygen. This inhibits the fish and other aquatic life and the lake becomes useless.

### 2.9.7 Disposal into Water Bodies

The disposal of treated wastewater is allowed in water or on land. The quality, quantity and use of the water body decide the degree of treatment required for the sewage. Since the treated wastewater may still have a high coliform bacterial density it should be disinfected also before disposal so that it may not cause microbial pollution. Disposal of wastewater in a river causes organic, chemical and microbiological pollution. Organic pollution not only depletes the oxygen content resulting in the killing of aquatic plants and animals but also leads to heavy algal growth downstream. The waste assimilating capacity of the river depends on its self-purification properties. The estimation of the self-purification properties is very important to protect and promote various beneficial uses to which the river water is put to. Actually the wastewater discharge into the river should be regulated in such a way that it does not exceed its waste assimilating capacity. To achieve this aim, wastewater treatment, wastewater reduction, alternative waste disposal points and methods and increase in the quantity of dilution water are sought.

The capacity of the oceans to absorb wastewater is less in comparison to the rivers because of its low oxygen content and high dissolved solid content even though there is much more water for dilution. As the specific gravity of seawater is greater and temperature is lower than that of wastewater, the warmer and lighter wastewater will rise to the surface when discharged into the sea resulting in the spreading of the wastewater as a thin film. Looking to the special characteristics of the marine ecosystem the outfall (last portion of the sewer line) should be carefully designed and located taking into consideration the sea currents, wind direction, wind velocity, tidal cycle etc. Theoretically speaking the wastewater should be disposed only during low tides to prevent backing up and spreading of wastewater. Practically it is difficult to store the wastewater for such a long time. So the wastewater should be taken to a distance of 1 to 1.5 km into the sea from the shoreline and discharged into deep sea at a point 3 to 5 m below the water level.



For the above requirements of planning and design the basic information to be collected are as follows:

- (i) Study of the quantity and quality of the treated effluent including its toxicity.
- (ii) Hydrographic surveys and examination of available hydraulic and hydrographic records like the run-off records at and below the point of disposal.
- (iii) Observations on currents and effects of wind and temperature stratification upon the dispersion of sewage.
- (iv) The effect of winds, salinity and temperature stratification upon the movement of sewage for tidal estuaries.
- (v) Studies of possible location for and forms of sewer outfall in its relation to hydrographic conditions for lakes and oceans outfalls.
- (vi) Studies of the various uses of the receiving water like for bathing and other recreational facilities, protection of aquatic life, prevention of sludge bank formation, avoidance of ugly conditions (for tourism) etc.

For well arranged points of effluent discharge there is no serious threat of ground water quality. Generally in unsewered suburban residential areas domestic wastewater (sewage) is disposed through cesspools, septic tanks and subsurface dispersion systems. Adequate precautions are to be taken to ensure that the water sources are not contaminated in such cases.

#### ***2.9.7.1 Disposal on Land***

As there is increasing scarcity of irrigation water, the disposal on land serves both the purposes of water requirement of crops and disposal of wastewater. The nutrients like nitrogen phosphorus and potassium alongwith the micronutrients like iron copper etc. make the wastewater effluent very much useful for sewage farming. Raw sewage should not be disposed directly for farming. Sewage after primary treatment may be used in some cases, but the disinfection is always a must. It protects the workers against the infection by disease producing micro-organisms and helminthes. It also saves the users of the farm products. The soil over which the sewage is applied must have a good permeability and infiltration capacity like 5 cm per day or more. Generally all soils are capable of sewage farming with good management of course.

The following table shows the effluent discharge standards.

#### ***Effluent Discharge Standards***

- I – Inland surface water
- II – Public sewer
- III – Irrigation
- IV – Marine coastal area.



Table 2.9 Effluent Discharge Standards

	I	II	III	IV
pH	5.5-9.0	5.5-9.0	5.5-9.0	5.5-9.0
Total Suspended Solids	100	600	200	100
Total Dissolved Solids	2100	-	2100	-
Chemical Oxygen Demand	250	-	-	250
Biochemical Oxygen Demand	30	350	100	100
Oil & Grease	10	20	10	20
% Sodium	-	-	60%	-
Chloride	1000	1000	600	-
Fluoride	2	15	-	15
Sulphate as SO <sub>4</sub>	1000	1000	1000	-

### 2.9.8 Onsite Sanitation

For small communities in rural or semi urban areas or even in most of the towns of India where sewerage system is still a dream, onsite system of sanitation prevails. The conventional off-site excreta disposal method, water borne sewerage system followed by a sewage treatment and disposal plant is generally not affordable in these areas. Some on-site low cost disposal methods like septic tanks and soak pits have been developed to have some alternative methods. These are not so effective as the sewerage system even then they are in use because of the economy considerations. Actually there is a growing scarcity of water and the present water carriage system where a very small amount of waste like excreta (say 1%) is carried by a large quantity of water (say 99%), has to be replaced by some other more economic way. It was good when the population was not so high and it was scattered on the earth. Now as the population is exponentially increasing and the rural area is becoming urban and more and more population is concentrating towards the cities, the waste assimilation capacity of the nature is falling short and short. In these conditions the on-site sanitation has become a useful solution though undesirable.

### 2.9.9 Septic Tank

A septic tank is a combination of sedimentation and digestion tanks where the sewage is held for 24 hours. During this period the settleable suspended solids settle down to the bottom. The direct outflow of the sewage is restricted by the provision of two baffle walls. The baffle walls divide it in three components and the sewage entering at anytime gets exit after about 24 hours. As the tank is built underground and there is no oxygen (and sunlight) so the anaerobic digestion of settled solids (sludge) and sewage takes place. The bacteria decomposes even the dissolved organic matter and thus reduces the BOD. This results in the reduction in the volume of sludge and release of gases like

carbon dioxide, methane and hydrogen sulphide. The hydrogen sulphide is an obnoxious gas and smells like rotten eggs so the problem of foul gases is always there and so it is called as a septic tank. Appropriate arrangement for the ventilation of the septic tank should be made. The effluent of the septic tank although clarified to a large extent, will still contain appreciable amount of dissolved and suspended putrescible organic solids and pathogens. Therefore the effluent of septic tanks should be carefully disposed but practically it is not treated further and just follows either some natural nallah or remains on ground which creates further problems. So it is suggested only for small communities and where we cannot afford the sewerage systems. Based upon the design criteria as per the manual the following table shows the recommended sizes of septic tanks upto 20 users.

**Table 2.10 Recommended Size of Septic Tanks**

No. of users	Length (m)	Breadth (m)	Liquid depth (cleaning interval of) (m)	
			2 years	3 years
5	1.5	0.75	1.0	1.05
10	2.0	0.9	1.0	1.4
15	2.0	0.9	1.3	2.0
20	2.3	1.1	1.3	1.8

In the above table the capacity has been calculated with the assumption that only the latrine (W.C) discharge is allowed in the septic tank. A provision of 300 mm should be made for free board (extra space for safety and accumulation gas etc.)

### 2.9.10 Soak Pits

When water table is low and the soil is porous (as in desert areas) soak pits are preferable. It is easy to construct a soak pit and cheap also. It is a circular pit with a dry masonry lining (without mortar). A size of 3.0 m diameter and 3 m depth is sufficient for a moderate family of 5 persons for a cleaning period of 7 years in porous soil. The whole sewage of the house can be accommodated in this and nothing comes out of it so there is no problem of treatment and disposal. Actually it is planned and constructed in such a way that the water of sewage is soaked in the soil and penetrates deep under the ground. The only consideration is of ground water table. It should be deep so that either the percolating sewage does not mixes with it or it gets purified in its journey through the soil layers before it mixes with the ground water. After all if it mixes with the ground water the pathogenic bacteria present in it shall contaminate the ground water and one has to treat the tube-well water before direct consumption. Unfortunately in India we assume the water from wells and tube-wells to be pure and potable and consume it directly without disinfection. Even the water flowing in the rivers or the stagnant water of ponds is directly consumed without any hitch. No effort has been made to disinfect the wastewater going into the soak

pits or the drinking water coming out of the handpumps or the wells. Otherwise the soak pit is a very cheap and effortless solution of the sanitation problem. As there is no sewer line, treatment plant and requirement of space for the disposal it is very cheap and can be called as sewerless sanitation.

## **2.10 IN-HOUSE TREATMENT AND SAVING OF WATER**

As known to everybody there is an acute shortage of water, particularly the sweet fresh pure potable water. In majority of Indian cities and villages lesser water is supplied than the requirement. This is because of the increased population, urbanization, industrialization and changing pattern of rainfall due to the environmental pollution. The so-called high living standard has increased the water consumption. The main culprit is the water carriage system commonly known as the flushing system. In the present flushing system we use a large amount of water say 10 liters every time when we use the toilet for defecation or urination. This amounts to about 40% of the total domestic consumption. As there is no separate system of raw and treated water in an individual household we use the same highly treated water for this work also where even the raw water could have solved our purpose. So this high priced treated water is wasted in this work where even the treated sewage could have been used.

As per the research done by the author and so many others the non-foul (kitchen and bathrooms) wastewater (excluding human excreta) can be used for flushing and gardening without any major problem.

## **2.11 CONCLUSION**

Water is the basic need for human beings. After air it is the most essential daily input required for the very existence of the mankind. Water is the main constituent of our body and a certain quantity of pure water is required daily for our physical needs. It is used in many ways other than drinking but we call the whole amount consumed by a person daily as the drinking water requirement. Actually this is the most unfortunate part of the problem. For drinking and cooking etc. i.e. the direct consumption only about 5 liters of water is required per person per day. This water should be pure, sweet, and free from micro-organisms (known as potable water). But as we do not have separate water supply systems for potable water and water to be used for other purposes (cleaning) so we treat the whole water (with a very high cost) and then use it even for flushing. There is a dire need of change in this attitude.

The second problem is the present water carriage system in which 99% of potable water is used to carry 1% of solids (excreta). Thus, we convert the good quality of water in bad quality wastewater and then allow it to get mixed with the river water. The raw water flowing in the river is comparatively pure because of the self purification power of the streams. But as the quantity of waste water has increased more than the dry weather flow of the rivers, it converts them into practically a stream of wastewater. This again increases the cost of treatment of raw water.

The industrial effluent deteriorates the quality of surface as well as ground water. The ground water has been so much polluted with the heavy metals like arsenic that it has become carcinogenic and source of many diseases. The overexploitation of ground water has resulted in the deepening of ground water table and made its pumping non feasible or uneconomical. Most of the portion of Punjab and Rajasthan has been declared as dark zones. The governments being welfare governments charge very little cost for the water supplies and bear the major expenditure by themselves. This has promoted the wastage of valuable water and production of wastewater that has to be further treated at a very high cost.

Increasing the education level, increasing the awareness and increasing the people's participation in planning, execution and maintenance of water and wastewater management shall improve the situation. It is the duty of every citizen to conserve water, use it wisely and produce as less wastewater as possible (by reusing). This shall be the real contribution for the betterment of the society.

## **REVIEW QUESTIONS**

### **Section A- Water**

1. Describe the various water resources.
2. Sketch and describe simon's rain gauge.
3. Describe the surface sources of water supply with illustrations.
4. Describe the various constructions required for making a suitable source of surface water supply.
5. What do you mean by storage capacity of reservoirs ?
6. Describe the subsurface or underground sources of water supply.
7. Define porosity and permeability.
8. Tabulate the porosity and permeability of some common soils.
9. Explain the methods of assessment of the ground water yield.
10. Describe the various methods of drilling of tube-wells.
11. Describe the various methods of development of tube-wells.
12. What do you mean by yield of a tube-well?
13. Develop the expression for finding yield of tube-well in unconfined aquifer.
14. Develop the expression for finding yield of tube-well in confined aquifer.
15. Discuss the various water supply schemes with suitable examples.
16. Describe the term quality of water.
17. Tabulate the physical and chemical standards of water and their permissible limits.

18. What are the bacteriological & virological standards of potable water ?
19. Tabulate the various toxicological materials found in water and their limits.
20. Describe the physical characteristics of water.
21. Describe the chemical characteristics of water.
22. What do you mean by treatment of water? Briefly explain the various methods of treatment.
23. What is the importance of disinfection? Describe the various methods of disinfection.
24. What are the waterborne diseases?
25. What are the suitability criteria of good disinfectant?
26. What is residual chlorine? How do you measure it on site?
27. Describe the various water softening processes.
28. What is the requirement of pressure of water to be supplied to the residences?
29. What is aeration of water? Why and how is it done?
30. What is the purpose of water softening? Explain various methods of water softening.

### **Section B- Wastewater**

1. What do you understand by wastewater management?
2. Describe the statutory water and sanitation boards.
3. Describe the method of design of sewer line alongwith the hydraulics of sewers.
4. What do you mean by treatment of wastewater?
5. Define biochemical oxygen demand and chemical oxygen demands.
6. What are the various unit operations and processes in water treatment?
7. What are the various unit operations and processes in wastewater treatment?
8. Describe the various methods of treatment of wastewater.
9. Tabulate the functions and efficiencies of various treatment units.
10. Explain the anaerobic digestion and the biogas.
11. Describe the disposal of treated wastewater.
12. Write a short note on Eutrophication.
13. Describe the disposal of wastewater in water bodies.
14. Describe the disposal of wastewater on land.
15. What are the various methods of onsite sanitation.
16. Describe the septic tanks and soakpits.
17. Explain the inhouse treatment of wastewater and saving of water.

# AIR POLLUTION

---

## 3.1 INTRODUCTION

Air (containing oxygen) is a vital requirement for sustaining life. Initially on the atmosphere of earth there was no oxygen and even then the life was there. Slowly the oxygen requiring organisms developed with the evolution of oxygen and at present there is about 21% oxygen in the atmosphere and almost every creature consumes it for its metabolism. Fortunately nature has the process of photosynthesis in which the green plants produce oxygen ( $O_2$ ) in presence of sunlight and consume carbondioxide ( $CO_2$ ). Thus the concentration of  $O_2$  is recouped and the  $CO_2$  produced by the human and natural activities is consumed.  $CO_2$  as such is not a harmful gas. It acts like glass in green house effect and thus keeps the earth warm. Actually it allows the sun's shortwave radiation to pass through it and does not allow the earth's longwave heat radiation to escape through it. Thus it keeps the earth warm. Had there been no  $CO_2$  on earth it would have been not habitable. The temperature of earth's surface would have been negative in the absence of it. So that way it is a useful gas. Then why do we curse  $CO_2$  for global warming? Global warming means increase in the temperature of earth resulting in over melting of ice and raising of water level in the oceans and increase in vector borne diseases and the discomfort. Here lies the concept of 'Pollution'. Pollution means mixing of anything which is undesirable, leading to some harmful effect. As the case of  $CO_2$  is there, a certain percentage of  $CO_2$  is desirable to keep the earth warm and cozy, but beyond that it increases the temperature so high which is undesirable and thus causes air pollution.

The clean dry air has following average composition:-

Table 3.1 Composition of Air

<i>Component</i>	<i>By volume</i>	<i>By weight</i>
Nitrogen	78.084%	75.51%
Oxygen	20.946%	23.15%
Argon	0.934%	1.28%
Carbon dioxide	0.033%	0.046%
Neon	18.180 ppm	12.50 ppm
Helium	5.240 ppm	0.72 ppm
Krypton	1.190 ppm	2.90 ppm
Xenon	0.087 ppm	0.36 ppm
Nitrous oxide	0.500 ppm	1.50 ppm
Methane	2.0 ppm	1.2 ppm
Hydrogen	0.5 ppm	0.03 ppm
Ozone	0.01 ppm	

Undesirable changes in the above composition, or mixing of harmful solid particles (suspended particulate matter) or addition of sound beyond particular level (db) is known as air pollution.

### 3.2 FORMAL DEFINITION OF AIR POLLUTION

The air Act of Govt. of India (amendment 1987) defines air pollution as “air pollution means any solid, liquid or gaseous substances present in the atmosphere in such concentrations that may tend to be injurious to human beings or other living creatures or plants or property or enjoyment”.

Perkins (1974) defined air pollution as “air pollution means the presence in the outdoor atmosphere of one or more contaminants such as dust, fumes, gas, mist, odour, smoke or vapour in quantities or characteristics and of duration such as to be injurious to human, plant or animal life or to property or which unreasonably interferes with the comfortable enjoyment of life and property.” This definition includes only ‘outdoor atmosphere’, but the indoor pollution is more severe these days, because of the emissions from kitchen and faulty planning.

Alongwith solid, liquid and gases sound should also be added to it. Undesirable levels of sound known as noise is a form of the air pollution as sound travels through air. Actually the air pollution matters much to the human beings as an average adult consumes 12 Kg of air per day which is about 12 times more than the food consumption. That is why the air pollution matters more than the other forms of pollution. Secondly in extreme cases it proves fatal quickly where as generally the other pollutions like soil or water pollutions act slowly. In some of the known calamities like London Smog

(1952) more than 4000 persons died because of indiscriminate use of coal. Actually in calm cold atmospheric conditions because of non-dispersion of smoke it becomes fatal smog (smoke + fog). The condensed water vapour present in the air (fog) traps the pollutants like oxides of sulphur and particulate matter (tiny solid particles floating in the air) leading to fatal action on human beings. Even in Bombay (1986) it (smog) affected the health condition of thousands of people, though nobody died. In December 1984, methyl isocyanate gas leaked from the Union Carbide pesticide plant and about 2500 people died and about 2 lac were seriously affected. There are so many other such incidents in the worldwide history which are enough for us to have a serious thought regarding the control of air pollution. The following table shows some of the major air pollution disasters,

### 3.2 Major Air Pollution Disasters

<i>Time of occurrence and location</i>	<i>Causes</i>	<i>Effects</i>
Meuse Valley (Belgium) Dec. 1930 (3 days)	Thermal inversion of gases (SO <sub>2</sub> , sulphur trioxide aerosol and fluorides) from industrial plants	60 persons died, thousands were effected,
Donora (USA), Oct.1948 (4 days)	Anti cyclonic weather (no air movement) temperature inversion and fog SO <sub>2</sub> with oxidation products and particulate matter were the main culprits	20 persons died, about 7000 ill. Complete darkness was observed due to gases and soot.
London from Dec. 5 to December 9, 1952,	Extensive use of coal (sulfur content 1.5%). Concentrated smoke had thermal inversion. The smoke mixed with fog became dangerous smog.	4000 died, thousands ill.
London, January 1956	Similar as above	1000 died
London, Dec. 1962	Shallow inversion, fog gases	700 died
Newyork, Nov. 1966	Smoke, SO <sub>2</sub> , particulates	168 died
Tokyo, June 18, 1970	Smog poisoning	6000 affected
Bhopal India Dec. 1984	In Union Carbide industry toxic gas methyle isocyanate leaked accidentally	About 2500 died and over 100000 were severely affected. Some still have the eyes and other problems.

## 3.3 CLASSIFICATION OF POLLUTANTS

### 3.3.1 Classification of Air Pollutants

- (i) Natural Contaminants
- (ii) Aerosols
- (iii) Gases



**Natural Contaminants:** Pollen is important natural contaminant because of its peculiar properties of irritation and allergy sometimes leading to bronchitis, asthma and dermatitis. Pollen grains are the male gametophytes of gymnosperms and angiosperms and they are discharged into the atmosphere from plants etc. The air transported pollen grains range mainly between 10 and 50 microns.

**Aerosols:** Aerosols refer to the dispersion of solid or liquid particles of microscopic size in the air. It can also be defined as a colloidal system in which the dispersion medium is gas and the dispersed phase is solid or liquid. The term aerosol is applicable until it is in suspension and after settlement due to its own weight or by addition with other particles (agglomeration) it is no longer an air pollutant. The diameter of the aerosol may range from 0.01 (or less) micron to 100 micron. The various aerosols are as follows:-

**(i) Dust:** Dust is produced by the crushing, grinding and natural sources like windstorms. Generally the dust particles are over 20 micron in diameter. They do not flocculate but settle under gravity, but smaller particles like 5 micron form stable suspensions.

**(ii) Smoke:** Smoke is made up of finely divided particles produced by incomplete combustion. Generally it consists of carbon particles of size less than 1.0 micron.

**(iii) Mists:** Mist is a light dispersion of minute water droplets suspended in the atmosphere ranging from 40 to 400 micron in size.

**(iv) Fog:** Fog is made up of dispersion of water or ice near the earth's surface reducing visibility to less than 500 m. In natural fog the size of particles range from 1.0 to 40 micron.

**(v) Fumes:** Fumes are solid particles generated by condensation from the gaseous state after volatilization from melted substances. Fumes flocculate and sometimes coalesce.

**Gases:** Following are the main air pollutant gases

- (i) Sulphur dioxide:** It is a major air pollutant gas produced by the combustion of fuels like coal. The main source of electricity production is by burning of fossil fuels in India and the whole world. The sulphur content of the coal varies from 1 to 4% and fortunately the Indian coal is low in sulphur content.  $\text{SO}_2$  is also produced in the metallurgical operations.
- (ii) Oxides of nitrogen:** Oxides of nitrogen are produced either in the production of nitric acid or in the automobile exhausts and as the effluent of power plants. Out of the seven oxides of Nitrogen ( $\text{N}_2\text{O}$ ,  $\text{NO}$ ,  $\text{NO}_2$ ,  $\text{NO}_3$ ,  $\text{N}_2\text{O}_3$ ,  $\text{N}_2\text{O}_4$ ,  $\text{N}_2\text{O}_5$ ) only nitric oxide and nitrogen dioxide are classified as the main pollutants. All the oxides of nitrogen are collectively known as  $\text{NO}_x$ .
- (iii) Carbon monoxide:** It is produced because of the incomplete combustion of coal and other petroleum products. It is produced in the exhaust of automobiles. In the pollution check of vehicles mainly CO and unburnt hydrocarbons are measured.

- (iv) **Hydrogen sulphide:** Hydrogen sulphide is an obnoxious (bad smelling) gas. It is produced mainly by the anaerobic (in absence of air) decomposition of organic matter. Other air polluting sulfur compounds are methyl mercaptan ( $\text{CH}_3\text{SH}$ ) and dimethyl sulphide ( $\text{CH}_3\text{SCH}_3$ ) etc.
- (v) **Hydrogen fluoride:** It is an important pollutant even in very low concentrations. It is produced in the manufacturing of phosphate fertilizers.
- (vi) **Chlorine and hydrogen chloride:** It is mixed in the air either from the leakages from water treatment plants or other industries where it is produced or used. Hydrogen chloride is also evolved in various industrial chemical processes. The main effect of chlorine is respiratory irritation which may be fatal.
- (vii) **Ozone:** It is a desirable gas in the upper layers of atmosphere as it absorbs the UV radiation of sunlight. But near the earth surface it is a poisonous gas. It makes poisonous chemicals by photochemical reactions.
- (viii) **Aldehydes:** They are produced by the incomplete oxidation of motor fuels and lubricating oil. They may also be formed because of photochemical reactions. Formaldehydes are irritating to the eyes.

### 3.2.2. Primary and Secondary Air Pollutants

Primary pollutants are those that are emitted directly from identifiable sources. Secondary air pollutants are those that are produced in the air by the interaction of two or more primary air pollutant.

#### Examples of primary air pollutants:-

- (i) Fine (less than  $100\mu$ ) and coarse (more than  $100\mu$ ) suspended particulate matter
- (ii) Oxides of sulfur
- (iii) Oxides of nitrogen
- (iv) Carbon monoxide
- (v) Halogens
- (vi) Organic compounds
- (vii) Radioactive compounds

#### Secondary air pollutants:-

- (i) Ozone
- (ii) PAN (peroxy acetylene nitrate)
- (iii) Photochemical smog
- (iv) Acid mists

Smog is the most important and dangerous one out of the above. Smog is a mixture of two words – smoke and fog. It can be of two types, photochemical or produced by coal.

Photochemical smog occurs in high motorized areas under adverse meteorological conditions (no wind), by the interaction of hydrocarbons and oxidants in presence of sunlight. Its main constituents are nitrogen oxides, peroxy acetyl nitrate, carbon monoxide and ozone. It causes severe eye irritation, reduces visibility, damages vegetation and cracks the rubber. The coal- based smog occurs due to the mixing of smoke in calm cold (below 10 degrees) conditions with the sulfur compounds and fly ash etc.

Basically, when dispersion of the pollutants is restricted due to non- movement of air and cold conditions, smog is produced. Its harmful effect depends upon the exposure time for which a person is affected. It can be fatal for long exposures (London smog).

### 3.4 CLASSIFICATION BASED ON POSITION

Another way of classification of air pollutants is the source being stationary or mobile. This way they can be classified as:-

- (i) Point source (large stationary source as power plants)
- (ii) Area source (small stationary sources like residential heating)
- (iii) Mobile source (line source like highway vehicles or area source like Aircraft at airports)

The following table shows the different air pollutants and their major sources.

**3.2 Air Pollutants with their Sources**

S. No.	Air pollutant	Source
1	Particulate Dust, SPM, RSPM etc.	Abrasion, quarrying (stone mining), soil erosion fuel combustion in automobiles, building and other civil construction, Industrial effluents, mining, power station, etc.
2	Oxides of sulphur (SO <sub>x</sub> )	Power houses, smelters, coal and other fossil fuels combustion, sulphuric acid plant, automobiles etc.
3	Oxides of nitrogen	Combustion, automobiles, acid manufacturing
4	Hydrogen sulphide	Petroleum industry, wastewater treatment, tanneries, oil refineries etc.
5	Carbon monoxide	Metabolic activity, fuel combustion, automobile exhaust
6	Ozone	Photochemical reactions
7	Lead	Automobile exhaust
8	Organic solvents	Solvent use, paints, pesticides, cooking, cosmetics etc.
9	Mercury	Pesticides, paints, laboratories
10	Fluorides (HF)	Glass and ceramics, cement factories, aluminum industry, fertilizer industry etc.

The following table shows the allowable limits of major air pollutants in air.

**Table 3.4 Allowable Limit of Some Important Air Pollutants in Air**

<b>Pollutant</b>	<b>Concentration in ambient air in microgram/m<sup>3</sup></b>			
	<b>Time weighted average</b>	<b>Industrial area</b>	<b>Residential, rural and other areas</b>	<b>Sensitive area</b>
Sulphur dioxide	Annual Avg.* 24 hours**	80 120	60 80	15 30
Oxides of nitrogen as NO <sub>2</sub>	Annual Avg. 24 hours	80 120	60 80	15 30
Suspended particulate matter	Annual Avg. 24 hours	360 500	140 200	70 100
Respirable particulate matter (size less than 10 mm)	Annual Avg. 24 hours	120 150	60 100	50 75
Lead(Pb)	Annual Avg. 24 hours	1.0 1.5	0.75 1.0	0.5 0.75
Carbon monoxide	8 hours 1 hours	5.0 10.0	2.0 4.0	1.0 2.0

\* Annual arithmetic mean of minimum 104 measurements in a year taken twice a week, 24 hourly at uniform interval.

\*\* 24 hourly/8 hourly values should be met 98% of the time in a year. However 2% of the time it may exceed but not on two consecutive days.

The air pollutants have harmful effect on human beings, animals, plants and even on the buildings. The air pollutants may have their origin from vehicular emissions or by other industrial or other human or natural activity. The following tables show their harmful effects.

**Table 3.5 Harmful Impacts on Human beings by Vehicular Emissions**

<b>Pollutant</b>	<b>Health effects</b>	<b>Impacts on environment</b>
Carbon monoxide	Fatal at high doses. Attacks the nervous system.	Acts like CO <sub>2</sub> , i.e. traps the earth's heat.
Hydrocarbons	Cause eye irritation, coughing and drowsiness. High molecular	Produces the dangerous photochemical smog.

Contd....

	weight compounds can be cancer producing (carcinogenic)	
Oxides of nitrogen	Asthma and loss of immunity	Acid rain
Benzene	Carcinogenic	-
Ozone near earth surface	Eye irritation	Impairs the growth of plants
Lead (Pb)	Impairs the mental ability	water pollution, SPM

**Table 3.6 Harmful Effects of Air Pollutants on Human Health from Different Air Pollutants.**

<b>Pollutant</b>	<b>Harmful effect</b>
Asbestos	Disease of lungs (Fibrosis, asbestosis) tumors, lung cancer
Arsenic	Bronchitis, dermatitis, skin cancer
Aldehydes	Irritation of eyes and respiratory track
Beryllium	Systemic poison causes berilliosis, skin damage
Chlorine	Irritation to eye, nose, throat. Bronchitis, pneumonitis
Cadmium	Highly toxic, causes bronchitis, fibrosis of lungs hypertension, carcinogenic
Lead	Systemic poison, causes anemia ( reduction of haemoglobin) affects kidney function, damages brain
Mercury	Highly toxic, enzyme poison, nervous system disorder
Nickel	Respiratory disorder
Pesticides	Various insecticides, herbicides, fungicides, nematocides and repellants are toxic and produce headache, stomach disturbances and irritations.
Radioactive	Somatic (on body cells) effects including leukemia (blood cancer), and other cancers. Genetic effects are mainly mutations in gem cells
Selenium	Irritation to eyes, nose, respiratory tract and gastrointestinal tract, badly affects kidney, lungs and liver
Vanadium	Affects gastrointestinal tract and respiratory tract. Cholesterol synthesis inhibition, carcinogenic

### 3.5. HARMFUL EFFECTS OF AIR POLLUTION ON MATERIALS

The air pollution affects the materials in following ways:-

- (i) Abrasion (loss of material by wind with coarser particles).
- (ii) Corrosion ( acidic effect of rain water).
- (iii) Deposition and removal (adhering substances like SPM and removal of material by rusting).
- (iv) Direct chemical attack (effect of gases like SO<sub>2</sub>).
- (v) Indirect chemical attack (action of acid or its fumes on stones like marble, corrosion of reinforcement due to diffusion of gases in RCC).

The following table shows the harmful effects of air pollution on some materials:

**Table 3.6 Harmful Effect of Air Pollution on Material**

<b>Material</b>	<b>Pollutant</b>	<b>Effects</b>
Stone like marble, outside plaster, paints and polishes	SO <sub>2</sub> , acid fumes, acidic rainwater	Discoloration, peeling
Metals, reinforcement	SO <sub>2</sub> , acid fumes, gases	Tarnishing of surface, corrosion, rusting
Rubber (tires)	Gases like ozone, oxidants	Cracking
Paper and fabric	Acid fumes, gases	Embrittlement, discolouration

### 3.6 CONTROL OF AIR POLLUTION

Prevention is always better than cure. So one should try to prevent the air pollution by changing the raw material, the process conditions, procedure and by having the preventive maintenance one can prevent the air pollution. For this purpose some of the examples are as follows:-

- (i) Controlling the spread of coal dust by sprinkling water on it before handling in a thermal power plant.
- (ii) Preventive maintenance by repairing leaky valves in advance so as to prevent the leakages of the harmful gases in air.
- (iii) Applying zoning to distribute the impact of air pollution in a community.
- (iv) Selection of proper material. For example using low sulfur coal reduces the SO<sub>2</sub> problem.

In addition to the preventive measures one has to have control technologies as follows.

Depending upon the situation different control technologies are adopted. For dealing with the particulate matter the following control technologies are used,

- Settling chambers
- Cyclone separators
- Fabric filters
- Electrostatic precipitators
- Wet collector (scrubbers)

The first two of the above are used for coarse particulates where as the other three are used for fine particulates.

For gaseous pollutants the following control technologies are used.

- Condensation
- Absorption
- Adsorption
- Combustion

For the control of gases such as  $\text{NO}_2$  and  $\text{SO}_2$  produced in combustion, wet and dry scrubbers are used.

### 3.7 CONTROL OF AUTOMOBILE POLLUTION

The major automobile pollutants are carbon monoxide, unburnt hydrocarbons and the oxides of nitrogen. These are generated by evaporation of fuel from carburetor, leakage between piston rings and cylinder wall and combustion of fuel (exhaust gases). To prevent the automobile pollution the law can be enforced at two levels. The industry can be compelled to manufacture the vehicles in such a way, i.e. enforcing the Euro standards, that they produce minimum pollutants. Secondly, the user has to maintain the vehicle by its proper servicing (tuning of engine) in such a way that the exhaust emissions are under control. Actually, at this level nobody bothers, as the checking systems and the provision of genuine penalty is very difficult. The general public is not aware of the bad effects of pollution particularly the air pollution that is many times more effective. The third control should be on the quality of fuel. If the fuel is having lead in it, neither the vehicle nor the owner can prevent its emission to the ambient air. That is why unleaded petrol is being supplied these days. Sometimes Kerosene is mixed with petrol or diesel (as it is cheaper) than the emissions are more pollutant and are of different nature. Even after exercising all such checks on quality of vehicles, maintenance and the adulteration some pollution is inevitable. This can be reduced by changing the fuel, such as by the use of CNG. In Delhi the use of CNG was made mandatory in the public vehicles by law and then a substantial reduction in the air pollution was observed. The other most important way of reducing the air pollution is changing the life style of the urban population. Minimizing the use of vehicles by walking for small distances, pooling of the vehicles, switching off the vehicles on red lights, maintaining the vehicles in proper order, adopting efficient ways of driving, ban on overloading, better design and maintenance of roads, collectively can reduce automobile air pollution.

The vehicular pollution can also be controlled by using the catalytic converter.

#### 3.7.1 Catalytic Converter

The exhaust emissions of a vehicle are carbon dioxide and water if the fuel in it is burnt with full efficiency. Practically the complete burning of every hydrocarbon molecule does not take place. The inadequate mixing of air with the fuel leads to the production of carbon monoxide. Also the high temperature and pressure in the engine leads to the combination of oxygen and nitrogen of the air to make oxides of nitrogen. So the exhaust emissions have the CO, unburnt hydrocarbons and the oxides of nitrogen as the air pollutants. To prevent this pollution the exhaust is passed through a catalytic converter to convert them into harmless chemicals. The inner side of the converter is composed of an array of tubes, each coated with a porous ceramic. Small particles of platinum and rhodium are embedded in this coating. As the temperature of the converter reaches above  $300^\circ\text{C}$  the pollutants bind temporarily to the catalysts.



With this reaction the CO gets converted to CO<sub>2</sub>, Hydrocarbons get converted to water and the oxides of nitrogen gets converted to nitrogen. Actually, a very small amount of the precious metal (say 5 grams) is sufficient to work in a device fitted with an ordinary car. The requirement of rhodium is also very less (say one gram) but it should run on the unleaded petrol to avoid the coating of lead which makes it useless. The overheating of catalyst metal particles should also be prevented to check the merging of particles and hence the reduction in their life. As there are no moving parts in a catalytic converter it can work for many years and for long mileage if the overheating is prevented and unleaded petrol is used. So this is a very good device to check the air pollution caused by vehicular emissions.

It can be stated now that all the sources of air pollution collectively increase either the concentration of solids in the form of particulate matter or the gases like CO<sub>2</sub>, NO<sub>x</sub>, SO<sub>x</sub>, CO etc. The harmful effects of the gases and the suspended particulate matter (particularly those which are so small that can be inhaled) have already been discussed. There are some other harmful effects of the S.P.M. and the gases like CO<sub>2</sub>. It has been observed that a significantly increasing volume of solids (particulate matter) entering the atmosphere, scatters (hinders) the sunlight. About half of the solar energy reaches the earth because of the absorption and reflection etc. in the atmosphere. This reduces the amount of sunlight (and its heat) that reaches the earth. On the other side the temperature of the earth is continuously increasing because of the greenhouse effect.

### 3.8 NOISE POLLUTION

Noise is an unwanted unpleasant sound that irritates us. The noise is caused by the vibration of matter and these vibrations are transmitted in a continuous medium as waves. Human ears receive these waves and the brain interprets them. The unit of measurement of sound is decibel. Decibel is a relative unit based on logarithm of the ratio of the sound intensity to a reference level. The reference level is arbitrarily established as a sound pressure of 0.0002 microbars that is considered to be an intensity level just audible to human beings. The sound that the human ears can hear lies between 20 to 20000 hertz (cycles/second) and in intensity from 0 to 130 decibels after which permanent damage may take place. More details are available about noise pollution in the eighth chapter.

### 3.9 GREENHOUSE EFFECT & GLOBAL WARMING

The sun shines at a high temperature i.e. about 6000 degree Kelvin. The solar radiation at this temperature is short-wave radiation which can pass through the glass. If there is a glass chamber the solar radiation comes through the glass and heats up the belongings inside. These heated up air or the other belongings radiate heat as the long wave radiation. Glass is opaque to the long wave radiation and thus it does not allow the inside heat to go out. Thus the temperature of that house keeps on increasing to (certain limit) depending on the conditions. For example it can go to 25°C inside the



house even if the outside temperature is minus 20°C. This phenomenon is used for growing greenery at this comfortable, suitable temperature inside that house. This is known as the **greenhouse effect**. CO<sub>2</sub> plays the same role in atmosphere. It allows the short-wave radiation of sun but does not allow the earth's long wave radiation to escape. That way it is a very useful gas as it keeps the earth warm otherwise the temperature of earth would have been negative and the present life would have not been there. But the increasing concentration of CO<sub>2</sub> (because of human activity like industrialization urbanization etc.) is increasing the temperature of the earth to a harmful level. As an estimate the temperature of the earth is increasing by 1°C per century. This is known as **global warming**. This appears to be small increase but this much increase in the mean global temperature (approximately 14.5°C) amounts to be very high and harmful to the peaks. The increasing temperature is substantially increasing the melting of ice on poles and other glaciers. This higher melting of ice is shortening the glaciers, flooding the rivers and increasing the levels of seas and oceans. There is a danger that these increased levels shall submerge the places like Mumbai and Mauritius within a short time to come. The increased temperature increases different vector borne diseases like malaria etc. The increased temperature is very much uncomfortable and requires more electricity for cooling. If the current trend of increase in the greenhouse gases continues it shall make the earth hell, so it has to be checked immediately by all means.

### 3.10 ACID RAIN

As described already the main gases as air pollutants are SO<sub>x</sub> and NO<sub>x</sub>. CO<sub>2</sub> is always present in the atmosphere as a natural constituent. When the rain fall occurs it dissolves the CO<sub>2</sub> present in the air and makes the carbonic acid. This makes the rain slightly acidic and reduces its pH. The reduction of pH upto 5.6 is considered as normal and it is not termed as acidic rainfall. Due to industrialization and the automobile exhaust SO<sub>x</sub> and NO<sub>x</sub> are present in the air in large quantities. When they react with the moisture to form sulfuric and nitric acids they make such rain as acid rain (acidity below pH 5.6 level). This mixing may take place at any place and the rainfall may take place at a very far off place. Moreover, during this journey significant chemical and physical changes may take place to aggravate the situation.

Acid rain is not a recent phenomenon, but has been reported way back in 1852 in Manchester, England. Actually, with rapidly growing use of electricity produced by coal and other fossil fuels serious problem of acid rain has emerged in US, Canada, Europe and China. Initially, the acid rain affected area was confined and the intensity was also lesser (pH above 4.5). But it increased by 1966 and there were several locations in southern Netherlands and Rhine valley in Germany with a pH lower than 4.0. South China reported acid rainfall of pH in the range of 4.3 to 5.5. Even in India the problem of acid rain has started. Annual SO<sub>2</sub> emissions in India has almost doubled in the last decade which has resulted in low pH value of rain water but still it is in control as fortunately the Indian coal has low sulphur value.

The following table gives details about the formation of acid rain:

**Table 3.8 Formation of Acid Rain**

<b>Pollutant</b>	<b>Combinations</b>	<b>Products</b>
Sulfur dioxide	(i) SO <sub>2</sub> with water (ii) Oxidation of sulfurous acid (iii) Oxidation of SO <sub>2</sub> (iv) SO <sub>3</sub> with water	(i) Sulfurous acid (ii) Sulfuric acid (iii) Sulfurous trioxide (iv) Sulfuric acid
Nitrogen dioxide	(i) NO <sub>2</sub> with water (ii) HNO <sub>2</sub> with water	(i) Nitrous and nitric acids (ii) Nitric acid
Carbon dioxide	CO <sub>2</sub> with water	Carbonic acid
Hydrogen fluoride	HF with water	Hydrofluoric acid

This acid rain strongly harms every where and everybody, may it be a building, human beings, animals, plants, the fresh bodies of water or the soil. It has rendered thousands of lakes useless because of the acidity through out the world. High acidity kills the fish and other aquatic animals and plants. Green algae and many useful bacteria are killed due to acidity. The killed organism and destroyed plants increase the organic matter and as the rate of its decomposition reduces the situation becomes worst.

Acid rain adversely affects the soil and the vegetation. As it accelerates the leave surface erosion the growth of plants is hampered and the trees are badly affected. As we know that the trees reduce the CO<sub>2</sub> and increase the O<sub>2</sub> they are our life supporting systems.

They pump the useless subsoil water to the atmosphere by transpiration and thus increase the humidity which results in rainfall. They absorb the SPM, SO<sub>x</sub> and NO<sub>x</sub> and thus directly reduce the air pollution. They reduce the soil erosion, velocity of air (spreading desert), velocity of rainwater (floods) and they also absorb sound (reduce noise pollution). Trees reduce the atmospheric glare and give us a feeling of nourishment and smoothening. They provide us so many types of useful things like fruits, wood, medicines, gum, herbs, pulp, and leaves etc. They provide shelter (habitat) to the birds and animals. Such useful trees and vegetation are destroyed by the acid rainfall.

The acid rain can be reduced by

- (i) Using low sulfur coal
- (ii) Gasification
- (iii) Alternative fuel to coal
- (iv) Alternative methods of power generation like the renewable sources of energy, like solar, wind, hydro-electrical, biomass etc.
- (v) Desulfurization of fuel gas

The other environmental problem of air pollution is ozone depletion.

### 3.11 OZONE DEPLETION

Though ozone is harmful gas near the earth surface (photo toxic) it is very useful in the upper layers (15 to 40 Km) of the atmosphere (stratosphere). 90% of the ozone is concentrated in the stratosphere and absorbs 95% of the UV radiation. It is useful gas there, as it absorbs the ultraviolet portion of the solar radiation which is very much harmful to human beings. It produces skin cancer and other diseases. Unfortunately because of the air pollution this ozone layer is depleting and wherever the concentration becomes very low it is termed as ozone hole. It came to our notice that the supersonic aircrafts release large quantities of nitric acid that reacts with the ozone and thus breaks the protective layer. It was also realized that the main culprit for ozone layer depletion are chlorofluorocarbons (CFCs). The generally used chlorofluorocarbons are CFC11 and CFC12 (Freons). As they are non reactive, odourless, nonflammable non toxic and non corrosive they are extremely used in air conditioners, refrigerators and some sprays. CFCs stay for a long period in stratosphere (more than 50 years) and during this period each chlorine atom is capable of converting up to  $10^5$  molecules of ozone to  $O_2$ .

The chlorofluorocarbons release free radical of Cl that removes one 'O' from  $O_3$ . The chlorine atom and oxygen atom make chlorine monoxide ClO. Then the free oxygen 'O' pulls the other 'O' and free radical of Cl is produced. The free radical attacks another  $O_3$  molecule and thus the chain keeps on reducing the  $O_3$ . The following three constituents are mainly responsible for the depletion of stratospheric ozone:-

- (i) **Nitric oxide molecules:** Nitric oxide reacts with ozone to make nitrogen dioxide which in turn reacts with atomic oxygen to produce nitric oxide again

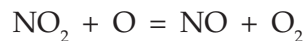
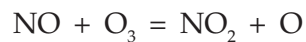

- (ii) **Chlorine atom:** Chlorine atom reacts with ozone to give chlorine monoxide which reacts with atomic oxygen to regenerate chlorine atom again

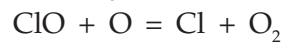
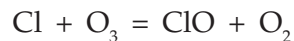

- (ii) **Hydroxyl ion:** The photo dissociation of water molecules produces hydroxyl ion which reacts with ozone molecule to produce  $HO_2$  which reacts with another ozone molecule to give again the OH molecule

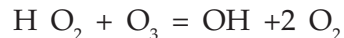
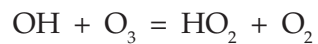

#### 3.11.1 Causes of the Ozone Layer Depletion

- (i) **Use of chlorofluorocarbons:** As discussed earlier mainly the CFCs are responsible for maximum damage to the ozone layer.

- (ii) **Nitrogenous fertilizers:** Microbiological action on nitrogenous fertilizers produces nitrous oxide which escapes into atmosphere and gets accumulated as its decomposition is difficult.
- (iii) **Supersonic transport:** Supersonic jetliners, rockets and space shuttles discharge various oxides of nitrogen, carbon, hydrocarbons etc. Ammonium perchlorate used in many of the rockets releases plenty of chlorides to attack the O<sub>3</sub>.
- (iv) **Nuclear tests:** Huge quantity of gases are released in the nuclear explosions which damage the ozone layer.

### 3.11.2 Effects of Ozone Layer Depletion

As the concentration of ozone reduces in the protective layer the harmful ultraviolet radiation (UV-A, UV-B and UV-C) shall reach the earth surface and shall cause many diseases like the following:

- (i) Skin cancer of various types including the dangerous melanoma. About 1 lac people die from this disease. As an estimate the cases of skin cancer are doubled with a 25% reduction in ozone layer.
- (ii) The ultraviolet radiation directly increases the cataract (disease of eyes).
- (iii) The UV radiation affects the eyes of wild life also and as they cannot protect themselves this effect is more pronounced.
- (iv) The depletion of ozone lead to increased photochemical smog and degradation of outdoor paint and plastic.

### 3.11.3 Preventive Action to Ozone Depletion

In 1987 in Montreal city of Canada a convention was organized in which an international agreement was signed known as "Montreal Protocol". It was made effective from 1<sup>st</sup> January 1989. Its goal was to cut emissions of CFCs by 35% from 1989 to 2000. After the observation of ozone hole above Antarctica in 1989, officials of more countries (93 nos.) met in London in 1990 and in Copenhagen and adopted the Copenhagen protocol that made the phasing out of ozone depleting chemicals more fast. At present 177 countries have joined their hands to protect the ozone layer and India is one out of them. The Government of India is having a time bound programme to cut the ozone depleting substances like CFCs, Helons, tetrachloromethane etc. Many alternatives for CFCs are available these days, like HCFC22, HFC 134A and hydrocarbons.

## 3.12 CONCLUSION

Air is the basic requirement of human beings. A person can live without water for some days, without food for some weeks but cannot live without air for more than some minutes. Oxygen is mainly required for the purification of blood in our body and that is available in plenty in the air. There is no scarcity of air or oxygen (as was in the case of water) but the problem of pollution is still there. Pollution here means mixing

of harmful undesirable gases and solid particles. The gases are a part of air but when their concentration increases they become harmful. For example CO<sub>2</sub> is a useful gas but the increased concentration increases the temperature of earth. The other gases like oxides of nitrogen, sulphur and SPM are the causes of the human ailments. So the duty of environment engineer is to prevent this pollution by planning the projects in such a way that the emissions are within limit. The vehicular pollution is as bad as the industrial one. Let us design such vehicle that use solar energy or the hydrogen energy or the wind energy, means any clean form of energy. Increasing the efficiency should mean in a holistic way, i.e. also for all others. If we think, plan execute and maintain the engineering processes in such a way that do not deteriorate the environment and help in sustaining its basic characteristics, it shall be the real service of the society.

The time has come that the whole world has to act in fighting climate changes with green groups in a combined manner. The efforts are on, and the surveys done by UN climate panel has recently disclosed that it is almost 90% certain that mankind is to blame for global warming. They have warned for more hunger, draughts, heat waves and rising seas. The report says that stabilizing greenhouse emissions will cost between 0.2% and 3% of world gross domestic product by 2030, depending on the stiffness of the curbs on rising emissions of greenhouse gases. The report gives solutions such as capturing and burying emissions from coal fired power plants, a shift to renewable energies such as solar and wind power, more use of nuclear power, more efficient lighting and insulation of buildings.

### REVIEW QUESTIONS

1. What do you mean by air pollution?
2. Tabulate the composition of air.
3. Discuss the problem of air pollution.
4. Enlist the major air pollution disasters.
5. Describe the classification of air pollutants.
6. Describe the aerosols as air pollutants.
7. Describe the various air polluting gases.
8. What are the primary and secondary air pollutants?
9. Describe the classification of air pollution based on position of the source.
10. Enlist the allowable limit of the air pollutants in air.
11. Tabulate the harmful impacts of air pollution on human beings by vehicular emissions.
12. Tabulate the harmful impacts of different air pollutants on human beings.
13. Tabulate the harmful impacts of different air pollutants on materials.
14. Discuss the methods of controlling the air pollution.

15. Discuss the methods of controlling the automobile pollution.
16. Describe the catalytic converter.
17. What is greenhouse effect?
18. What is global warming and its effects?
19. Describe acid rain, its formation, the harmful effect and control strategies.
20. Describe ozone depletion, its harmful effects and causes of ozone depletion and its prevention.

**This page  
intentionally left  
blank**

# **SOLID WASTE MANAGEMENT**

---

## **4.1 INTRODUCTION**

Anything that is not of further use in a process is known as waste for that process. That can be useful for other process and can be termed as raw material for that process. So actually waste is a misplaced resource. When this waste is in a comparatively solid form it is known as the solid waste. Whatever may be the form of waste, it deteriorates the environment if it is disposed in an offensive manner. The waste water and its treatment and disposal have already been discussed.

Solid waste is defined as discarded solid fraction produced from domestic, commercial, trade, industrial, agricultural, institutional, mining activities and public services. The waste is a term that means useless, unwanted or discarded material.

According to the American Public Works Association the solid waste is classified in twelve categories as, garbage, rubbish, ashes, Street sweepings, dead animals, abandoned vehicles, construction/demolition waste, industrial refuse, special waste such as hospital waste, bulky waste, animal and agricultural waste, and sewage treatment residue (semi solid fraction known as sludge).

Solid waste includes domestic waste, municipal waste, commercial waste, garbage (animal and vegetable waste), rubbish (inorganic excluding ashes), ashes and industrial waste, sludge from wastewater treatment plants etc. Actually, mainly the population living in the urban area produces much more solid waste than the rural one. As there is more employment potential in urban area the urban population has increased from 10.84% in 1901 to 25.7% in 1991. The class I cities has increased from 212 to 300 during 1981 to 1991, while class II cities has increased from 270 to 345 in the same period.



As the living style in urban area is totally different from rural area (sanitary system, industrialization etc.), much more solid waste is produced in urban area. Actually more is the (so called) advancement, higher is the solid waste production. Because of poverty, life style, the habit of living with nature and lesser population density, lesser waste is produced in rural areas of our country. So basically solid waste problem is more related to the cities or towns and as the cities are increasing the problem is being aggravated.

To handle the problem of solid waste in an efficient manner is known as the solid waste management. This management is a part of public health and sanitation and as per the Indian constitution it is the responsibility of states. In the states various local bodies like municipalities (in towns) or the municipal corporations (in cities) or the development authorities (in big cities) are to deal with solid waste management. Generally, the water supply and electricity are on the top priority of the state government and because of various reasons even they are in short supply. Then comes the collection conveyance treatment and disposal of wastewater. Unfortunately, the solid waste management comes on the last priority. Only a few efforts have been made to create community awareness about the bad effects of poor solid waste management or to reduce the generation of solid waste. Because of the poor education system and lack of strong will power there is no successful systems of solid waste management in any city of India (with a very few exceptions). There is practically no penalty for throwing anything on the roads or the nearby premises. Nobody, minds and cares in living in such foul conditions. When it end in a calamity like the recent plague in Surat city of Gujarat, only then we think about the solid waste management, and that too only for some days. The basic thinking process of the society has rotten. Nobody, minds in misusing every resource if it is money wise affordable. Actually, waste is a misplaced resource. If we plan in such a way that there is a thoughtful consumption of every thing, nothing shall come out as 'waste'. Nature has given us many cycles by which everything becomes useful and regenerated. The organic matter (nightsoil, excreta, food, vegetable, paper) can be converted into useful biogas and compost. Everybody knows about it. But the problem is of separating it from the inorganic waste like ashes, rubbish, non bio-degradable waste. When the solid waste is a mixture of all these, the separation or segregation becomes costly. The segregation is a must otherwise the extraction of energy in the form of gas, heat or fertilizer is not possible or uneconomical. So, this segregation must be done at the producer end. The producer must either have some incentive or penalty for this. Unfortunately both are not there in our country and the required wisdom is also not there.

So we are living on a heap of solid waste in most of the places. It is estimated that the total solid waste generated by 300 million people in urban India is 38 million tons per year. Or in other words it is estimated that 1,00,000 ton of municipal solid waste is generated in India daily. Depending upon the status of the city the per capita generation of solid waste is from 0.2 to 0.6 kg per day. Higher is the status more amount of the waste is produced. In so called advanced countries this figure is much more,

but there they observe strict rules and regulations. Even the dogs are not allowed to defecate on the roads where as in India it is a common practice for the human beings living in slums without a toilet.

The problem other than generation of solid waste is its misplacement. Most of the solid waste generated inside the premises are thrown on the roads. There is no effective door to door collection system or a self motivated culture of putting the waste in the bins or at the designated places for it. Consequently the 60 to 70% of the meagre budget available with the municipalities is spent in street sweepings. 20 to 30% of the budget is spent in transporting it to the disposal site. Thus, hardly 5% remains for scientific sanitary disposal of the waste and so it is either burnt in open to produce harmful gases or left to scatter here and there. If it is dumped as such it pollutes the soil, rain water or the ground water by leachates (dark concentrated foul wastewater produced by the decomposition of biodegradable matter in absence of oxygen).

So there is an urgent need of understanding the mechanism of solid waste management. For this purpose first of all let us discuss the classification of solid waste.

#### **4.2 CLASSIFICATION OF SOLID WASTE**

The solid waste can be classified as per the Manual on Municipal Solid Waste Management, Government of India publication as follows:

- (i) **Domestic/Residential waste:** This type of waste is originated from single or multifamily household units. These wastes are generated from the household activities such as cooking (ashes) cleaning (dust) repairs (residues), hobbies (unuseables), redecoration, empty containers, used packets, old clothes, books, papers, broken glass, plastic items, broken and useless furniture.
- (ii) **Municipal waste:** Municipal waste includes waste resulting from municipal activities and services such as street sweepings, dead animals, market waste and abandoned vehicles. Generally, this term 'Municipal Waste' is used in a wider sense to incorporate domestic wastes, institutional wastes and commercial wastes.
- (iii) **Commercial waste:** This category includes solid wastes that originate in offices, wholesale and retail markets, restaurants, hotels, warehouses (godowns) and other commercial establishments.
- (iv) **Institutional waste:** These are those wastes generated from institutions such as schools, colleges, universities, hospitals and research institutes. Some of these wastes (like hospitals) may be hazardous (more bad, offensive, strong, disease producing) waste.
- (v) **Garbage:** Garbage is the term applied to animal and vegetable wastes generated from the handling, storage, sale, preparation, cooking and serving of food. Such wastes contain putrescible (easily and quickly biodegraded with bad smell) organic matter. This attracts rats, flies, mosquito and other vermin, that is why it requires immediate attention.

- (vi) **Rubbish:** It is a general term applied to solid wastes originating in households, commercial establishments and institutions excluding garbage and ashes.
- (vii) **Ashes:** These are the residues from the burning of wood, coal, charcoal, coke and other combustible matter for cooking and heating in houses institutions and small industries. When produced in large quantities in thermal power plants (fly ash) they are known as industrial wastes. Ashes consists of fine powdery residue, cinders and clinkers often mixed with small pieces of metal and glass.
- (viii) **Bulky waste:** Bulky wastes are large household wastes that cannot be accomodated in the normal storage containers of the household and thus they require special collection. Actually in India there is hardly any waste collected in this category as it is sold to the kabaries.
- (ix) **Street sweepings:** The waste collected from streets, walkways, parks etc. is known as street sweepings. In developing countries like our country manual street sweeping is done and it makes the largest portion of the municipal solid waste as we are in a habit of throwing everything on the streets. It includes mainly dust, dirt, plastic bags (thin), dry leaves, useless papers, cardboard, rags, tyres, vegetable matter etc. In our country most of the usable portion of the waste like rags, paper, thick plastic bags, plastic utensils, any form of metal is collected by the rag pickers. The organic matter including the paper and even plastic sheets is consumed by cows and other stray animals. Only in big cities or the developed countries they form the part of waste. That is why the calorific value of Indian solid waste is far less in comparison to the other countries.
- (x) **Dead animals:** This term includes the dead animals that die naturally or by accidents on roads. It does not include the animal parts from slaughter houses which are regarded as industrial waste. There are two types of dead animals, large and small. The smaller ones like dogs cats rabbits, rats etc., are either consumed by the other animals or can be easily lifted and disposed. The large ones like cows, horses, camels etc. require special and immediate attention as traffic is affected and they emit foul smell.
- (xi) **Construction and demolition waste:** These are the wastes generated by the residue of the construction, refurnishment, repair and demolition of houses, commercial buildings and other structures. Generally, the demolition waste is used by the contractors in filling low lying areas and the plinth filling of new houses and nothing is left on the sites. Even then some small quantity of sand, stone or concrete may be left.
- (xii) **Industrial wastes:** The discarded solid material of manufacturing processes and industrial operations comes in this category. There is a vast range of

substances that are unique for each industry so they are considered separately from municipal wastes.

- (xiii) **Hazardous waste:** Hazardous waste is defined as wastes of industrial, institutional or consumer origin that, because of their physical, chemical or biological characteristics are potentially dangerous to human beings and the environment. In some cases the active agents may be liquid or gaseous, they are classified as solid waste because they are confined in solid containers. Typical examples are solvents, paints, and pesticides whose spent (empty) containers are frequently mixed with municipal wastes and become part of the urban waste stream. Certain hazardous waste can explode in the incinerators (controlled large kilns) and cause fires at land fill sites. Others such as pathological (disease producing) wastes from hospitals and radioactive waste, require special handling at all times. Proper management practice should ensure that hazardous wastes are collected, stored, transported and disposed off separately, preferably after treatment to make them harmless.
- (xiv) **Sewage waste:** The solid by-products of sewage treatment are classified as sewage wastes. They are mostly organic and produced from the treatment of organic sludge from both the raw and treated sewage. The inorganic fraction of raw sewage such as grit is separated at the preliminary stage of treatment, but because it entrains putrescible organic matter that may contain disease producing bacteria (pathogens), must be buried or disposed off quickly.

#### 4.2.1. Importance of Classification

Any one method of classification of solid waste is not sufficient because of the heterogeneous nature of solid wastes. Actually, the real knowledge of solid waste characteristics is very much essential to conceive the treatment and disposal. Sometimes the waste is disposed with extraction of energy out of it. For example electricity is generated or biogas is produced. In both these cases the waste must have a minimum value of calorific value or the organic matter respectively. It has happened in many cases like that of plant in Timarpur that did not work due to the different characteristics of the waste than those for which the plant was designed. Actually, the plant are generally imported and are based on higher calorific value solid waste whereas the average Indian solid waste has larger fraction of inorganic waste (dust, dirt, silt etc.), with lesser organic matter (vegetable, paper and other combustible matter), and hence has a very low calorific value (Kcal/Kg). So the knowledge of the characteristics and composition of the solid waste is utmost important. The classification of solid wastes as per the manual on SWM is given in a tabular form as follows:

Table 4.1 Classification of Solid Waste in Tabular Form

<b>Type of solid waste</b>	<b>Description</b>	<b>Sources</b>
Food Waste (garbage)	Waste from preparation, cooking and serving of food market refuse, waste from handling, storage and sale of meat and vegetables	Households, institutions and commercial centers such as hotels, stores, restaurants, markets etc.
Rubbish	Combustible (primarily organic) paper, cardboards, cartons, wood boxes, plastics, rags, clothes, beddings, lather rubber grass, leaves yard trimmings. Non combustible (primarily inorganic) metals, tin cans, metal foils, dirt, stones bricks, ceramics, crockery, glass bottles, other mineral refuse	As above
Ashes and residues	Residues from fires used for cooking and for heating buildings, cinders, clinkers, thermal power plants.	As above
Bulky waste	Large auto parts, tyres stoves, refrigerators, other large appliances, furniture, large crates, branches of trees etc.	As above
Street waste	Street sweepings, dirt, leaves, catch basin dirt animal droppings content of litter receptacles dead animals	Streets, sidewalks, alleys, vacant plots
Dead animals	Small animals: cats, dogs, poultry etc. Large animals: horses, cows etc.	Same as above
Construction and demolition waste	Plumber, roofing and sheathing scrap, rubble broken concrete plaster, conduit pipes, insulating wires etc.	Construction and demolition sites, remodeling, repairing sites
Industrial waste & sludges	Solid wastes resulting from industry processes and manufacturing operations, such as food processing wastes, boiler house cinders, wood plastic and metal scraps and shavings etc., sludge of sewage treatment plants and septic tanks, coarse screenings grit etc.	Factories, power plants, treatment plants etc.
Hazardous waste	Hazardous wastes: pathological waste, explosives, radioactive material toxic waste etc.	Households, hospitals, institutions, stores, industry etc.
Horticulture wastes	Tree trimmings, leaves, waste from parks and gardens etc.	Parks gardens roadside trees etc.

### 4.3 COMPOSITION AND CHARACTERISTICS OF SOLID WASTE

The composition and characteristics of municipal solid waste is not same throughout the world and even in the same country it changes from place to place and time to time. As explained earlier it depends upon the living standard, social customs, location of a place, climate and weather conditions etc. Higher is the standard of living, more is the waste produced. Alongwith the total quantity of waste produced, the composition of waste is also different for different income groups. The following table (as per manual on solid waste management) shows the patterns of composition, characteristics and quantities of solid waste for different income groups:

**Table 4.2 Composition, Characteristics and Quantities of Solid Waste for different income groups**

	<i>Low income countries</i>	<i>Middle income countries</i>	<i>High income countries</i>
Composition % by weight			
Metal	0.2–2.5	1–5	3–13
Glass, ceramics	0.5–3.5	1–10	4–10
Food and garden waste	40–65	20–60	20–50
Paper	1–10	15–40	15–40
Textiles	1–5	2–10	2–10
Plastic/Rubber	1–5	2–6	2–10
Inert	20–50	1–30	1–20
Density (Kg/Cu.m)	250–500	170–330	100–170
Moisture content	40–80	40–60	20–30
Waste generation Kg/capita/day	0.4–0.6	0.5–0.9	0.7–1.8

So it can be concluded that the waste from poor communities contain more dust, dirt, inert material and the totally useless food remaining (rotten items). It has a lesser amount of paper waste as it is used in lower income groups again and again and ultimately for cooking and heating. The density of waste in poor community is more because of the above reasons. The moisture content of the waste of poor countries is high which renders it difficult for incineration (controlled burning at high temperatures).

#### 4.3.1. Characteristics of Municipal Solid Waste in Indian Cities

As explained earlier the character of municipal solid waste is variable because of many reasons. It depends mainly upon the monetary level, but also the size of the city, its geographical conditions and the lifestyle. Simple conclusions cannot be drawn in each case and thus the solution to the problem of solid waste management should be site specific. The following table shows the research data from National Environmental Engineering Research Institute (NEERI), Nagpur. It is evident from the table that every

result is not but obvious and there are so many things that are to be explored before reaching to a conclusion.

**Table 4.3 Physical Characteristics of Municipal Solid Wastes in Indian Cities**

Population range in million	No. of cities surveyed	Paper%	Rubber, leather and synthetics%	Glass%	Metals%	Total compostable matter%	Inert%
0.1–0.5	12	2.91	0.78	0.56	0.33	44.57	43.59
0.5–1.0	15	2.95	0.73	0.35	0.32	40.04	48.38
1.0–2.0	9	4.71	0.71	0.46	0.49	38.95	44.73
2.0–5.0	3	3.18	0.48	0.48	0.59	56.67	49.07
> 5	4	6.43	0.28	0.94	0.8	30.84	53.90

**Table 4.4 Chemicals Characteristics of Municipal Solid Wastes in Indian Cities**

Population range (in million)	No. of cities surveyed	Moisture%	Organic matter%	Nitrogen as total Nitrogen%	Phosphorus as $P_2O_5$ %	Potassium as $K_2O$ %	C/N Ratio	Calorific Value (on dry weight basis) in kcal/Kg
0.1–0.5	12	25.81	37.09	0.71	0.63	0.83	30.94	1009.89
0.5–1.0	15	19.52	25.14	0.66	0.56	0.69	21.13	900.61
1.0–2.0	9	26.98	26.89	0.64	0.82	0.72	23.68	980.05
2.0–5.0	3	21.03	25.6	0.56	0.69	0.78	22.45	907.18
> 5.0	4	38.72	39.07	0.56	0.52	0.52	30.11	800.7

The observations of above tables may lead to useful conclusions by careful study. In the physical characteristics the content of paper waste normally increases for increasing population but the rubber etc., reduces as there are more chances of rubber recycling industries in bigger cities. Similarly, as the rag pickers are more active in big cities they pick up the light matter with more calorific value and thus the inert material is higher. Mostly the thin plastic bags form a major portion of the waste because in recycling the plastic has to be made firstly dirt free, means washing is a must. The thin sheets give lesser plastic material in comparison to the effort made in washing. So the rag pickers do not pick the thin plastic bags and that is why governments ban the thin plastic bags. The proportion of fine earth reduces with increase in population as the condition of roads improves in bigger cities.

The chemical characteristics indicate that as the inert matter increases with increase in population its calorific value decreases.



So there are many interrelated factors which make it difficult to predict the composition and characteristics of the solid waste of any city, it is better to take sufficient sample and analyze them for a long time before conceiving any treatment/disposal or energy extraction project.

#### 4.4 EXPECTED QUANTITIES OF SOLID WASTE

For the assessment of collection, conveyance, treatment and disposal, the expected quantities of solid waste generated in a locality must be known. NEERI has done extensive work and has measured the quantities of waste generated in the Indian cities. The quantity of waste produced is lesser in Indian cities as compared to the developed countries, because of the poverty and the way of living. Ours is a more natural way of living and nature has its cycles to recycle the waste. In India the average solid waste produced per capita per day vary between 0.2-0.6 kg/capita/day, the higher value is for metropolitan cities. The total solid waste generated in urban area (towns with population more than 5000 and having other amenities) is estimated to be around 38 million tones per annum.

The actual forecast of waste quantity is as difficult as is estimation of the waste composition. The quantity also depends upon the living standard, size of the community, climate, particular days ( like Diwali and other festivals), etc. Alongwith the quantity the density of the waste is also variable and it changes with the storage method, salvaging (sorting) activities, exposure to weather, handling methods and decomposition. It can be noted as a general rule that the lower is the level of economic development, the greater is the change in the density of waste from generation and disposal. The waste in developing countries get compacted upto the disposal point in such a way that its volume reduces to half.

The following table shows the quantities of solid waste in Indian urban centres (manual on MSWM).

**Table 4.5 Quantities of Solid Waste in Indian Urban Centres**

<i>Population range in million</i>	<i>Number of urban centres sampled</i>	<i>Total population (in million)</i>	<i>Average per capita value (Kg/capita/day)</i>	<i>Quantity (Tonnes /day)</i>
< 0.1	328	68.3	0.21	14343
0.1–0.5	255	56.9	0.21	11952
0.5–1.0	31	21.7	0.25	5432
1.0–2.0	14	17.18	0.27	4640
2.0–5.0	6	20.6	0.35	7209
> 5.0	3	26.3	0.50(@0.6kg/capita/day in metro cities	13153



The above table shows data for the existing cities surveyed. For the estimation of MSW generated in a proposed city (in future) following estimation can be done:

Expected residential waste:	0.3 to 0.6 kg/capita/day
Expected commercial refuse	0.1 to 0.2 kg/capita/day
Expected street sweepings:	0.05 to 0.2 kg/capita/day
Expected institutional refuse:	0.05 to 0.2 kg/capita/day.

If industrial solid waste is included in municipal waste for collection and disposal purposes, 0.1 to 1.0 Kg/capita/day may be added at the appropriate step. These generation rates are dependent upon the particular sites so they are to be supported by the field data.

Actually the solid waste quantity and quality both are very much variable and are dependent on many factors. It is very much difficult to anticipate in advance. So the waste generated should be carefully examined for quantity and quality and then only any activity should be planned. Without proper and exhaustive survey it may totally fail as in the case of Teemarpur energy recovery plant.

Before going into further details of collection, conveyance, treatment and disposal of solid waste one should know the important physical and chemical characteristics of solid waste.

#### 4.5 PHYSICAL CHARACTERISTICS

- (i) **Density:** The knowledge of density is important for the design of all elements of the solid waste management systems like storage, transport and disposal. For example for a known volume of the solid waste its density gives us the idea about the requirement of the truck in tonnage. Every truck or similar vehicle has a permitted load capacity say 12 ton or so which it can carry according to law. In developed countries as their waste is light so compaction reduces the cartage charges substantially. The density varies significantly from source to the disposal site because of handling, change in moisture content, densification due to vibration of movement, disturbance by animals and birds (scavengers) etc. The following table gives some data from MSWM for density of municipal solid waste in some Indian cities.

**Table 4.6 Density of Municipal Solid Waste produced in some Indian Cities.**

S. No.	City	Density in Kg/m <sup>3</sup>
1	Bangalore	390
2	Baroda	457
3	Delhi	422
4	Hyderabad	369
5	Jaipur	537
6	Jabalpur	395
7	Raipur	405

It is evident from the above table that density is more in Jaipur waste as because of desert conditions there is more sand and other inorganic heavy matter. These figures are only indicative and are to be verified before the actual design of a system. Actually it is very important that the solution to any SWM problem should be site specific and time specific. The same city may show different composition after some years.

**(ii) Moisture content:** Moisture content of the solid waste is expressed as the weight of moisture per unit weight of wet material.

Moisture content varies generally from 20 to 45% depending upon the climatic conditions and level of city (income group) etc. The increase of moisture content increases the weight and thus the cost of transportation and thus the storage section should take care of it.

**(iii) Calorific value:** Calorific value is the amount of heat generated from combustion of a unit weight of a substance, expressed as kilo calorie per kilogram. The calorific value is determined in the laboratory by Bomb Calorimeter. Table 4.3 shows typical values of the residue and calorific value for the different components of the municipal solid waste.

If the energy is to be recovered or the waste is to be disposed, by incineration (controlled burning) the following points should be considered:

- Organic matter gives energy only in dry condition.
- The moisture content as free water reduces the dry organic matter per kilogram and hence requires a significant amount of energy for evaporation.
- The ash content of the waste reduces the proportion of dry organic material per kilogram of waste. It also retains some heat.

So for economical recovery of energy the waste should contain minimum amount of moisture, ash and other inorganic matter.

These are the significance of determination of physical characteristics.

#### 4.6 CHEMICAL CHARACTERISTICS

The chemical characteristics of solid waste are determined for assessing the treatment process. Mainly three chemical characteristics are determined, chemical, bio-chemical and toxicological.

- Chemical quantities of solid waste in Indian urban centres are pH, nitrogen, phosphorus, and potassium (N-P-K), total carbon, carbon/nitrogen ratio, calorific value.
- Bio-chemical characteristics include carbohydrate, proteins, natural fiber, and biodegradable factor.
- Toxic characteristics include heavy metals, pesticides, insecticides etc.

Consideration of lipids (fats, oils and grease) should also be done as they are of a very high calorific value (about 38000 Kcal/kg). These days synthetic organic materials like plastic have become a significant component of solid waste accounting for 5-7%. In India the plastic is non-biodegradable and thus poses a great problem. It chokes the drains and if burnt it produces poisonous gases. The thin plastic sheets and bags are not recycled as the cost of making it dirt & oil free makes the process uneconomical.

All the above considerations of characteristics are required to design, conceive and assess the most appropriate ways of transportation, the requirements of treatment, extraction of energy and the safe, sanitary way of disposal for the protection of environment.

#### **4.7 WASTE MANAGEMENT APPROACH**

The solid waste management has a two fold approach. First is the minimization of waste at the source and other is the control on environmental pollution during its storage, conveyance and disposal.

Prevention is always better than cure. If the production of waste can be reduced at the source level it shall reduce the cost of conveyance treatment, disposal and shall save the environment. The waste minimization techniques are grouped in four major categories for hazardous as well as non hazardous waste, as follows:

##### **4.7.1 Inventory Management and Improved Operation**

- Inventorisation (making stock registers) and tracing of all raw materials.
- Purchasing of lesser toxic and more non-toxic production material.
- Implementation of employee's training and management feedback.
- Improving material receiving, storage and handling practices.

##### ***Modification of equipment***

- Installation of equipment that produce minimum waste.
- Modification of equipment to enhance recovery or recycling options.
- Redesigning of equipment or production lines to produce less waste.
- Improving operating efficiency of equipment.
- Observing strict preventive maintenance programme.

##### ***Modifications in Production Process***

- Selection of non-hazardous raw material.
- Segregation of waste for recovery.
- Identification and elimination of leakages.
- Optimization of reactions and raw material use.

**Recycling and reuse**

- Installation of closed-loop systems
- Recycling off site for another use
- Exchange of wastes

By adopting the above waste minimization techniques the waste is minimized at the source so that its handling and transportation charges are reduced and lesser efforts are to be done in disposal.

**4.7.2 Utilization of Waste**

After minimizing the waste at source one can think about the utilization of waste of one operation in the other operations as shown in the table below.

**Table 4.7 Utilization of Waste**

<b>S. No.</b>	<b>Waste</b>	<b>Areas of application</b>
1	Flyash (fine coal ash generated by combustion of coal in power plants etc. One portion is the bottom ash another is the one collected in the separators from the flue gases.)	i As raw material in manufacturing of cement ii As binding material with cement iii As filler in mines iv As plasticizer v As an aggregate in cellular concrete bricks and blocks vi For stabilization of soil
2	Blast furnace slag	i Manufacturing slag cement, super sulphated cement ii Making expansive cement, coloured cement and high early-strength cement iii In refractory and ceramic industry iv As a structural fill v As aggregate in concrete
3	Ferro-alloy and other metallurgical slag	i As structural fill ii In making pozzolana metallurgical cement
4	Byeproduct gypsum	i Gypsum plaster ii As retarder in cement setting iii As mineraliser
5	Lime sludge (phos-phochalk, paper and sugar sludges)	i As a sweetener for lime in cement manufacture ii Manufacturing of lime pozzolana brick/binders iii For recycling in parent industry iv Manufacturing of building lime
6	Chromium sludge	i As a raw material component in cement sludge

Contd....

		ii Manufacturing of coloured cement as a chromium bearing material
7	Red Mud	i As a binder ii Making construction blocks iii As a cellular concrete additive iv Coloured composition for concrete v In making floors and other tiles vi Red mud polymer door
8	Pulp and Paper	Lignin

After having all this information let us examine the present status of solid waste management and what should have been done.

#### 4.8 SOLID WASTE MANAGEMENT: AN OVERVIEW

The solid waste management has the following components:

- (i) Identification of waste and its minimization at the source
- (ii) Collection, segregation and storage at the site of collection
- (iii) Transportation
- (iv) Treatment
- (v) Energy recovery
- (vi) Disposal

##### 4.8.1 Identification of Waste and its Minimization at the Source

By the above described classification methods one can identify the waste easily. Identification helps in further processes of transportation, treatment and disposal, for example the hazardous waste is to be tackled in a different manner than the ordinary MSW. The minimization of the waste production is the best strategy. For this, first of all the process should be such that there is a least production of waste. For example if in a footwear making industry if the cut on the rubber sheet is made in such a way that alternate piece of the pair are placed one by the side of other; there shall be least production of waste sheet. Then the next step is to reuse the remaining waste sheet in the same process. But now there is a limit beyond which this cannot be used to maintain the required quality. This further remaining portion of the sheet comes as real waste to this process of footwear making. Now if a toy making machine is installed in the same factory which can use this remaining rubber sheet as the raw material. Then there shall be no waste production in the first factory and only the second unit shall produce some waste. Thus, the waste has been minimized at the source. This reduces the cost of transportation etc. everything.

The second example is the production of flyash as the waste in the thermal power plants. A huge quantity of flyash is produced where coal is burnt for making electricity.

This flyash requires a large valuable land for disposal. As this flyash can be used for making of flyash bricks, making of cement and can be used with cement as binder etc; if sold or supplied free of cost from the site itself ; shall reduce the burden of disposal.

The third example is the utilization of waste food products in a hostel or a hotel for making bio- gas. By the anaerobic digestion of this organic matter (waste food) the biogas can be produced easily. This gas can be used there itself for cooking or heating purposes. This shall reduce the biodegradable waste at the source itself.

The fourth example is the utilization of kitchen waste in a household in making the compost and utilizing it in the kitchen garden itself. If more advanced techniques like Vermi-composting are adopted this can be done in a more beneficial way.

The above mentioned methods can be adopted on a large scale also, but for that the waste is firstly collected, transported and than utilized. This incurs a large cost. So it is always preferable that if the waste production is minimized or the waste is reused, recycled at the source itself. Thus, the waste minimization is achieved through careful planning, changing attitude, sometimes special investments (as the toy factory in the above example), and most important is a real commitment. The self motivated willing reduction of waste is generally not possible, so strict enforcement of the law should be there. The waste reduction and reuse, recycling should be given incentives from the government in the form of tax reduction and soft loans.

#### **4.8.2 Collection, Segregation and Storage at the Site of Collection**

The main problem of solid waste management is the collection of solid waste. The household waste consists of all types of general waste. At present there is no scientific, clean, hygienic, efficient practice of waste collection in most of the cities of India including the metro cities. There is no practically imposed penalty on throwing of waste on the streets. Even defecating on open plots, sides of roads, railway lines; spitting on roads is a very common practice and nobody bothers about it. The ugly unhygienic scenes, and the bad smell (due to anaerobic digestion of organic matter) worsen the situation. Actually we are in a bad habit of either throwing the waste in front of the neighbor's door, or on a vacant land or directly on the road. Even if the municipality provides a waste collection bin, nobody bothers to put the waste carefully in it. So the collection of waste is a big problem. In most of the developing countries the waste is handled manually. First of all the sweepers sweep the roads, streets etc. with their age old brooms (with poor designs). Then they will make heaps of the collected waste. The other person then lifts this collected waste to some ill maintained wheel barrows and transport it to the collection depots and make a heap there. Then the rag-pickers shall start their work and pick only most useful items to them as the thick plastic bags or metal if any. The stray animals like dogs, cows, pigs shall find their food from this heap and scatter it on the collectyon site. Then it shall be manually picked up at some irregular interval, transported in open tractor trolleys and then disposed off on some open land.

The industrial waste is also handled in the same way. The collection and storage of waste is the most neglected operation in any industry. The wastewater having harmful colours, dyes, metals, heavy metals, organic matter (having high BOD) is discharged in the open drains to pollute the land and the river water. Similarly, the solid waste is thrown in open areas wherever the nearest site is available (may it be unguarded private land or government land).

The best way would have been the segregation of waste at the generation point. Segregation means collecting it in different bins, or plastic bags. The domestic waste can be broadly separated as reusable (paper, plastic, metal etc.), and non reusable. The non reusable may have organic matter like kitchen waste or inorganic matter like dust, dirt etc. The organic matter is liable to decomposition (putrescible) and thus requires immediate attention. Fortunately in India the usable matter is rarely discarded as solid waste except which cannot be sold to kabaries. So even if only two containers or bags are used for separating organic and inorganic waste the problem is solved. This separated waste should be regularly collected by the worker directly from the houses at some well defined time. Then it should be transported in (covered vehicles) to some waste collection depots for utilization/transportation to different sites. The organic waste can be used for the production of biogas or for the extraction of energy, incineration (controlled burning or making organic compost, and vermi-composting. The storage in the intermediate collection sites should again be covered and out of the reach of the stray animals. Here it is proposed to make payment to the person collecting waste on the basis of the weight/volume of the waste collected by him/her and not on the daily basis. Here lies the actual problem. Because of the structure of the local municipal corporations and many other pressures this is generally not feasible. This is possible only if this work is given on contract basis and the work is done in a scientific professional way with the people's participation (segregation and proper handing over of the waste).

#### **4.8.3 Transportation of Solid Waste**

As stated earlier the waste is transported from the storage depots to the disposal sites in tractor trollies or ill designed open trucks. Though it has been instructed by the Hon'ble court that the transportation must be done in closed containers only. The industrial waste must be transported separately and must be disposed in a safe way after suitable treatment. Any type of the hazardous waste should be labeled and coded so that in case of an accident the emergency services know how to handle a spillage. Actually the work of transportation of solid waste must be done through the technically competent and well reputed contractors under the strict supervision of the experienced and honest municipal authorities and watchful citizens.

#### **4.8.4 Treatment of Solid Waste**

The waste has to be treated before disposal for the protection of environment. In the treatment the biodegradable waste can be processed by composting, vermi-composting,



anaerobic digestion or any other appropriate biological processing for stabilization of waste. Actually every organic matter has a tendency to be converted into inorganic matter as the later is a stabilized form. If this conversion takes place in absence of oxygen (anaerobic digestion) which is a general case in solid waste processing, foul gases are evolved. During the anaerobic decomposition dirty, offensive dark coloured fluid is also generated that is known as the leachate.

Generally the solid waste contains both municipal and industrial waste. Small scale industries also generate huge quantity of solid waste and they are generally not in a position to treat their waste individually. It is therefore advisable that in a group of small scale industries the different wastes are characterized, identified, quantified and stored for treatment through a combination of recycling, recovery and reuse of resources such as, raw material, bio gas, steam and manure. The combined effluent treatment plants are to be operated by the local bodies where the cost of construction operation and maintenance is to be shared by the industry in proportion to the quality and quantity of their waste. However the assessment of the quality and quantity of waste is very difficult and requires appropriate testing facilities.

In any case the solid waste should be reduced in quantity at the source, segregated, then carefully transported and the economically treated before the final disposal.

#### **4.8.5 Energy Recovery and Disposal**

The most common methods of energy recovery and disposal for non hazardous solid waste are incineration, composting and landfill. The final disposal of waste should be done in such a way that it remains a waste in actual sense, i.e. nothing can be recovered out of it and it could not be used any where. So before putting it on land for land-filling if it has a substantial portion of biodegradable fraction then compost (organic manure) should be made out of it. This shall reduce the final volume of the waste to be disposed on land and shall give us money in terms of the manure. The organic manure is environment friendly and also provides us micronutrients that increase the fertility of the soil. If this work is done more effectively by some special worms this is known as vermi-composting.

##### **4.8.5.1 Incineration**

Incineration means burning of solid waste in controlled conditions. The most usual practice of disposal of solid waste is burning in open fields. This slow burning at low temperature produces many hazardous gases. Generally the waste is collected in the streets or roads and the heap of this waste is left there itself for drying or collection of more waste on it. Then this waste is either transported to some distant site or burnt there itself. This waste contains inorganic matter also and because of this burning in heaps there is no control of supply of oxygen or rather there is no oxygen supply except that present in the voids. This incomplete combustion at a low temperature produces hazardous gases and these gases pollute the environment very close to us. Particularly the gases produced by the burning of plastic, rubber and other such materials produce very much harmful gases.



Incinerator means any enclosed device using controlled flame combustion. Incineration uses heat to convert complex toxic organic compounds into mostly carbon dioxide and water. At temperatures ranging from 400 to 1600°C complex organic molecules break down into basic atoms. The incineration is a good method of disposal and recovery of energy (in the form of heat produced by burning) only if it works properly. The combustion temperatures of conventional incinerators are about 760° C in the furnace and more than 870° C in the secondary combustion chamber. These high temperature are required to avoid odour from incomplete combustion but are not sufficient to burn or even melt the glass. Some modern incinerators use supplementary fuel to produce high temperatures upto 1650° C to convert even metal and glass to ashes. These incinerators reduce waste volume significantly i.e. upto 97%.

There are so many factors like thermal feed rate, waste feed rate, organic chlorine feed rate, minimum combustion gas temperature, gas residence time, adjustment of primary and secondary combustion units, removal of HCl, Suspended Particulate Matter (SPM) and other air pollutants produced; that are to be controlled. Actually, the incineration is best way of disposing hazardous waste, like hospital and other wastes. The incineration is definitely better than open burning but as stated earlier if it is not properly working, with all controls, then it can prove to be more dangerous, as it gasifies the pollutants and sends them to the atmosphere.

In general incinerators comprise of a storage pit, fuel tanks, a furnace, a heat recovery boiler, effluent gas purification unit, an induced draft fan and a stack (chimney). Though incineration is extensively used as a useful method of waste disposal, it is associated with some polluting discharges which are of environmental concern. These can effectively be controlled by installing suitable pollution control measures and by construction of furnace suitably and by controlling the combustion process. For the removal of SPM from the effluent gas a scrubbing water treatment unit or even Electro Static Precipitators are used in good installations.

#### **4.8.5.2 Landfill**

The most common and easy way of disposal of solid waste is dumping it on land. The inorganic waste like construction and demolition waste can be easily used for filling of low lying areas or plinth filling of buildings or the earthwork of roads. When the combined waste (inorganic and organic) is disposed on the land then the decomposition of the organic matter takes place in due course of time. This decomposition produces gases (like methane) and dark coloured dirty offensive water known as leachate. If the ground on which the waste is disposed is pervious then this leachate percolates and mixes with the ground water and badly pollutes it. If the waste is hazardous means that contains harmful chemicals and heavy metals, or pathogens then the situation becomes more aggravated. The mixing of these pollutant through leachate makes the water polluted and contaminated. Secondly in open landfills the rain water increases the volume of leachate and mixes it with the ground or surface water source more easily. So the landfill should be so designed that it contains an impermeable barrier to stop

the mixing of leachate with the water. It should have a diversion for the rain water and proper arrangement of the collection treatment and disposal of leachate. Such type of landfill is known as the sanitary landfill and are the most desirable ones. They may appear costly, but for long lifetime of such works and comparing the end results the cost/ton of waste disposed might be less than any other method of disposal.

#### **4.8.5.3 Composting**

The organic matter (consisting of carbon, hydrogen, nitrogen, oxygen, and sulfur) has a tendency of being converted into inorganic matter as the later is a stable form. The food, excreta and other organic waste gets decomposed (changed into inorganic form) and produce gases like biogas (mainly methane) and solids of decomposition like sulfates, nitrates, phosphates etc. These solid (nutrient) are extracted by the roots of plants and trees in dissolved form and they again produce the organic matter in the form of their products. Those products come in the food chain and again the organic waste is produced. This way the different natural cycles keep on proceeding. Composting is an organized method of producing compost manure (decomposed organic matter) through this natural phenomenon. Compost is more useful as it contains the nutrients like N, P, K as well as the micronutrients. Micronutrients like iron are very much useful for good health and immunity. As the organic matter can be decomposed in two ways i.e. in the presence of oxygen or in the absence of oxygen, composting can be done aerobically or anaerobically. During aerobic composting aerobic micro-organisms oxidize the organic compounds to carbon dioxide, nitrite and nitrates. The reaction is exothermic and the temperature rises. The nitrates, sulfates etc. are used by the plants and carbon is synthesized in the photosynthesis by the plants. In the anaerobic process the anaerobic bacteria, while metabolizing the nutrients, break down the organic compounds through a process of reduction. The gases evolved are mainly CH<sub>4</sub> and CO<sub>2</sub> (bio-gas). If collected properly as in a biogas plant the gas can be used for heating or even for driving engines.

The composting can be done to the collected organic waste at some site or at the individual house hold.

##### **4.8.5.3.1 Vermi-composting**

In the case of households or colonies vermi-composting which involves the stabilization of organic solid waste through special earthworm by conversion of the organic matter to worm casting is also done. Vermicomposting involves the culture of earthworms(vermiculture) for the stabilization of different variety of organic solid waste. Earthworms feed on any organic waste and consume two to five times of their body weight, excrete the mucus coated undigested matter as wormcasts. Wormcasts consists of organic matter that has undergone physical and chemical breakdown through the muscular activity that grinds the material to a particle size of 1 to 3 micron. The nutrient present in the wormcast are easily soluble in water and are thus readily available for the plant growth. Vermi-composting is a rich source of macro and micronutrients, vitamins, enzymes, antibiotics and hormones.

As per the MSWM the vermi-composting involves the stabilization of organic solid waste through earthworm consumption which converts the material into worm castings. Vermi-composting is the result of combined activity of micro-organisms and earthworms. Microbiological decomposition of biodegradable organic matter occurs through extracellular enzymatic activities (primary decomposition) whereas decomposition in earthworm occurs in alimentary tract by micro-organisms inhabiting the gut (secondary decomposition). Microbes such as fungi, actinomycetes, protozoa etc. are reported to inhabit the gut of earthworms. Ingested feed substrates are subjected to grinding in the anterior part of the worms gut (gizzard) resulting in particle size reduction. Vermitechnology, a tripartite system which involves biomass, microbes and earthworm as influenced by the abiotic factors like temperature, moisture and aeration etc. Microbial ecology changes according to change of abiotic factors in the biomass but decomposition never ceases. Conditions unfavorable to aerobic decomposition result in the death of earthworms and subsequently on vermi-composting occurs. Hence, preprocessing of the waste as well as providing favourable environmental condition is necessary for vermi-composting. The vermi-compost (manure) is relatively more stabilized and harmonises with soil system without any ill effects. Unfavourable conditions such as particle size of biomass and extent of its decomposition, very high temperature increase, anaerobic condition, toxicity of decomposition products, etc. matter much for the activity and progress of worms.

This technology has been used for agriculture waste and is used on organic municipal solid waste also. The worms are special earthworms known as *Pheretima* sp, *Eisenia* sp, and *Perionyx excavatus* sp. These worms survive in the temperature range of 20-40°C and moisture range of 20-80%. The worms do not survive in pure organic substrate containing more than 40% fermentable organic substances. So fresh waste is mixed with partially or fully stabilized waste before it is subjected to vermi-composting. The worms are also adversely affected by high concentrations of such heavy metals as cadmium, chromium, lead and zinc. Due to these problems the vermi-composting is successful more on the household level (vegetables etc, organic waste) than the municipality level.

#### **4.9 ENERGY RECOVERY FROM MUNICIPAL SOLID WASTE**

The municipal solid waste contains organic (vegetables, food etc.) as well as inorganic matter (dust, dirt etc.). It is desirable that the energy present in its organic portion can be recovered through suitable processing and treatment technologies. Alongwith the gain of energy the following benefits are also there:

- (i) The total quantity of waste gets reduced by nearly 60 to 90% depending upon the characteristics of waste and the adopted process.
- (ii) As the quantity reduces the demand for land required for landfill as disposal also reduces.
- (iii) The cost of transportation also reduces as the quantity reduces.
- (iv) The overall environmental pollution reduces.

Therefore, the energy recovery is as useful as the reuse and recycle of waste at the source. Following are the basic techniques of energy recovery as per the MSWM:

- (i) **Thermo-chemical conversion:** This process entails thermal decomposition of organic matter to produce either heat energy or fuel oil or gas; and
- (ii) **Bio chemical conversion:** This process is based on enzymatic decomposition of organic matter by microbiological action to produce methane gas or alcohol.

The thermo-chemical conversion processes are useful for wastes containing high percentage of organic non-biodegradable matter and low moisture content. The main technological option in this category include Incineration (already explained) and Pyrolysis/ Gasification. The biochemical conversion processes, are preferred for wastes having high percentage of organic bio-degradable (putrescible) matter and high moisture content. The main technological option under this category is Anaerobic Digestion also known as Biomethanation.

#### 4.9.1 Parameters Affecting Energy Recovery

The main parameters that determine the potential of recovery of energy from waste are physical and chemical characteristics of waste and the recovery of energy also depends upon the process employed. The main physical parameters are:

- Size of constituent
- Density
- Moisture content

Smaller size of the constituents aids in faster decomposition of the waste due to more specific area. Waste of high density shows a high proportion of biodegradable organic matter whereas the low density indicates the higher presence of paper plastic etc. High moisture content causes biodegradable waste fraction to decompose more rapidly than in dry conditions. The high moisture content makes the waste rather unsuitable for thermo-chemical conversion (like incineration, pyrolysis, gasification) for energy recovery as a major amount of heat is wasted in evaporating the moisture.

The important chemical parameters for determining the energy recovery potential and the suitability of waste treatment through bio-chemical or thermo-chemical conversion are as follows:

- Volatile solids
- Fixed carbon content
- Calorific value
- Carbon and nitrogen ratio
- Toxicity
- Inerts

For different processes of energy recovery the desirable range for different parameters is shown in the table given below. Generally for achieving satisfactory extraction of energy sorting, segregation and addition of required parameters is necessary.

**Table 4.8 Desirable Range of important Waste Parameters for Technical Viability of Energy Recovery ( source manual on MSWM)**

<b>Waste treatment method</b>	<b>Basic principle</b>	<b>Important waste parameters</b>	<b>Desirable range (suitably processed waste)</b>
Thermo-chemical Conversion	Decomposition of organic matter by action of heat	Moisture content Organic/Volatile matter	< 45% > 40%
Incineration pyrolysis gasification		Fixed carbon Total Inerts Net-calorific value	< 15% < 35% > 1200 kcal/kg
Bio-chemical conversion	Decomposition of organic matter by microbial action	Moisture content Organic-Volatile matter	> 50% > 40%
Anaerobic digestion/ bio-methanation		C/N ratio	25–30

Like this energy can be recovered from the solid waste which reduces the volume also and makes the waste suitable for final disposal. Now the final disposal may be as landfill, but it has also to be done in such a way to protect the environment from its bad effects (like leachates etc.). That is known as sanitary landfill.

#### 4.10 SANITARY LANDFILL

The term 'Landfill' means a unit operation for final disposal of municipal solid waste on land, that is designed and constructed with the objective of minimum impact on the environment. The term sanitary landfill is used for a landfill with the provision of liner (protective layer) and leachate collection system to prevent ground water contamination. Landfilling is done for the mixed waste, that is not hazardous but not found suitable for waste processing, and recycling. Land fill is not suggested for biowaste as energy can be recovered out of it and its decomposition in the landfill shall produce leachates. Actually landfilling should be used as the final disposal method and should be adopted for the waste from which the recycling is not possible and economic extraction of energy is also not possible. Sometimes it is useful for hazardous waste disposal, but then it has to be done very carefully. The following are the essential components of a MSW landfill as per the manual on MSWM:

- (i) A liner system at the base and sides of the landfill which prevents migration of leachate or gas to the surroundings soil.
- (ii) A leachate collection and control facility which collects and extracts within and from the base of the landfill and then treats the leachate.
- (iii) A gas collection and control facility which collects and extracts gas from within and from the top of the landfill and then treats it or uses it for energy recovery.
- (iv) A final cover system at the top of the landfill which enhances surface drainage, prevents infiltrating water and supports surface vegetation.

- (v) A surface water drainage system which collects and removes all surface run-off from the landfill site.
- (vi) An environmental monitoring system which periodically collects and analyses air, surface water, soil-gas and ground water samples around the landfill site.
- (vii) A closure and post closure plan which lists the steps that must be taken to close and secure a landfill site once the filling operation has been completed and the activities for long term monitoring, operation and maintenance of the completed landfill.

#### 4.11 HAZARDOUS WASTE MANAGEMENT

It is difficult to define the hazardous waste exactly as it is a very general and wide term. However, it may be defined as any waste in solid, liquid or gaseous form which because of its quantity and concentration or its physical, chemical, radiological, or infectious characteristics, may cause ill effect on the human health or the environment if not properly stored, transported and disposed. The designation of a material to be hazardous is done through the standard tests for the following criteria:

- **Radioactivity:** If the level of radioactivity exceeds the permissible concentration limits the waste is termed as hazardous.
- **Bio-concentration:** This criteria is used for chemicals such as chlorinated hydrocarbon pesticides.
- **Flammability:** The ease with which certain substance catches fire and sustains combustion.
- **Reactivity:** Chemicals like sodium are extremely reactive with water.
- **Toxicity:** The capacity of causing damage to the human health and the environment, like the poisonous effect is the measure of toxicity.
- **Genetic and carcinogenic potential:** The potential of causing cancer etc.

By the above criteria the hazardous waste can be identified but the actual impact is based upon the quantity. It can be suggested that the most suitable method of dealing with hazardous waste is converting it into non-hazardous form, but that is not possible always, and may not be economical and technically possible also. The most commonly used method of disposing of hazardous waste is the hazardous waste landfill. The specially designed landfills are used to provide complete protection for the surface and subsurface waters from the hazardous waste. As they have to carefully deal with, such type of landfills are equipped with clay liners, monitoring wells and ground water barriers. The strategy is strict segregation from the environment and complete care in storage and transportation.

The Central Government has made the Hazardous Waste (Management & Handling) Rules, 1989 and has amended them on January 6, 2000. According to them, the occupier generating hazardous waste is bound to take all necessary steps to ensure that such



wastes are properly handled and disposed off without any adverse effect. The occupier shall also be responsible for the collection, conveyance, storage, treatment and disposal of these wastes in consultation with the pollution control boards. The manual on MSWM has a list of the categories of Hazardous Waste as specified in the schedule I to the rules amended on January 2000 by the government. The list includes for example petrochemical processes, natural gas production, production and use of zinc, lead, cadmium, arsenic etc., production of pharmaceuticals, preservatives, cosmetics, photo-chemicals etc.

The waste generated from medical activities can also be hazardous, toxic and even lethal because of their high potential of disease transmission. The hazardous and toxic part of waste from hospitals comprising infectious, bio-medical and radioactive materials as well as sharps (needles, knives etc.) creates a great risk if not handled properly. Actually a major part of biomedical waste is non-hazardous, but if proper segregation is not there it makes the whole waste as hazardous. Apart from a part of hazardous waste the biomedical waste should be studied separately.

#### 4.12 BIO-MEDICAL WASTE

As per the manual on MSWM the bio-medical waste means any solid and/or liquid waste including its container and any intermediate product, which is generated during the diagnosis, treatment or immunization of human beings or animals or in research pertaining there to or in the production or testing thereof.

The physico-chemical and biological nature of these components, their toxicity and potential hazard are different, necessitating different methods/options for their treatment/disposal in schedule I of the bio-medical waste (management and handling) Rules, 1998 the waste originating from different kinds of such establishment, has been categorized in different categories as below:

##### Components of bio-medical waste

- Human anatomical waste (tissues, organs, body parts etc.)
- Animal waste (as above from veterinary hospitals etc.)
- Microbiology and biotechnology waste, such as laboratory cultures, micro-organisms, human and animal cell cultures, toxins etc.
- Waste sharps, such as hypodermic needles, syringes, scalpels, broken glass etc.
- Discarded medicines and cyto-toxic drugs.
- Soiled waste such as dressings, bandages, plaster casts, material contaminated with blood etc.
- Solid waste (disposable items like tubes, catheters etc. excluding sharps).
- Liquid waste generated from any of the infected areas.
- Incineration ash.
- Chemical waste.

If the above mentioned bio-medical wastes are not handled properly they shall create many hazards. As per the manual on MSWM the following are the main environmental concerns with respect to improper disposal of bio-medical waste management:

- Spread of infection and disease through vectors (fly, mosquito, insects etc.) which affect the in-house as well as surrounding population.
- Spread of infection through unauthorized recycling of disposable items such as hypodermic needles, tubes, blades, bottles etc.
- Reaction due to use of discarded medicines.
- Toxic emissions from defective/inefficient incineration.
- Indiscriminate disposal of incinerator ash/residues.

For safe handling of the biomedical waste it is recommended that proper labeling and colour coding is done. It is desirable to use colour coding means use of specific coloured container with liner/sealed container (for sharps) for particular wastes. The untreated waste should not be stored for a period of more than 48 hours. For this purpose a simple notice in English, Hindi and local language describing clearly about the storage of a particular category of waste in a particularly labeled and coloured container is a must. The container should be sturdy enough, without any puncture and leakage. The container should be covered and preferably operated by foot. In case of plastic bags they should be fitted securely in a container. The sharps must be stored in a puncture proof container and before putting them in the containers they must be mutilated by a needle cutter. The containers should be wheeled and placed in a permanent position tightly. They should be carried for further transportation preferably from the separate corridors and should not cross the regular path of patients and visitors.

Different methods of treatment and disposal are useful for the different category of the bio-medical waste. Depending upon the quantity of waste generated small installations may adopt local (in house) disinfections, mutilation/shredding and autoclaving and off-site incineration at a common facility followed by a sanitary and secured landfill.

#### **4.13 CONCLUSION**

Waste is a misplaced resource. Solid waste can also be used for the production of bio- gas or compost. The paper waste can even be used for the paper mashie (making articles from paper) or for reusing it in hand made paper, bags etc. Reduction, and reuse of solid waste increases the efficiency of the process that is the main aim of the engineer. The other side of the coin is the nuisance caused by the solid waste. As it creates ugly scenes, mal-odour and unhygienic conditions so its proper disposal is a must. As there are so many producers (every individual) so it is very difficult to manage it. When we enforce it by law it becomes a problem for implementation. The poor standard and illiteracy of our citizens aggravates the problem and practically



every city of our country is in a bad shape as far as solid waste is concerned. Though the per capita production of solid waste is lesser in India but as it is not handled properly (scattered) so a large effort and money has to be spent in its collection. If every body puts the waste material after segregation (at the source) at its designated place the further handling and transportation becomes more feasible. This can be made possible by educating the masses and by providing some incentives. As we sell the newspapers and other sellable items the same system may be developed for other things like the kitchen waste. The main problem is its commercial utilization that makes it sustainable. Here is the role of engineer. If we can install energy recovery plants may it be a biogas plant, compost making plant, vermi-composting or plant for electricity production and run it successfully then we are the real engineers that think for the society. There are many technical problems of raw material, process applicable to Indian conditions and the inorganic nature of Indian solid waste. We have to find ways and means to overcome these problems within our social and economical network. At least this is sure that it can be done if a strong will power is there as some of the local self bodies, municipal corporations have done it. Increased awareness, education, training, incentive and people's participation all combined can achieve the aims and objectives of the solid waste management.

### Review Questions

1. Define the term waste. What do you mean by solid waste?
2. Describe 'solid waste management'.
3. What is the problem of solid waste? How much solid waste is produced in our country?
4. How do you classify the solid waste and what is the importance of classification?
5. What is hazardous waste and its problem?
6. Explain the terms garbage and rubbish.
7. Describe the composition of solid waste.
8. Tabulate and explain the physical characteristics of solid waste.
9. Tabulate and explain the chemical characteristics of solid waste.
10. What are the expected quantities of solid waste?
11. Tabulate the quantities of solid wastes in Indian urban centres.
12. Describe the physical characteristics of solid waste like density, moisture content etc.
13. Describe the chemical characteristics of solid waste.
14. Describe the waste management approach with inventory management etc.

15. How can the solid waste be utilized?
16. Write down the detailed overview on solid waste management.
17. Explain the different ways and means of collection of solid waste.
18. Explain the different ways and means of transportation of solid waste.
19. Explain the different ways and means of treatment of solid waste.
20. Describe the term energy recovery from solid waste.
21. What is incineration? Describe the process of incineration.
22. What is landfill? Describe the problem of leachate.
23. Describe the term composting, its methods and advantages.
24. What is vermi-composting? Explain the process and its advantages.
25. Write in details the method of energy recovery from solid waste. What are the parameters that affect the energy recovery?
26. What is the desirable range of waste parameters for technical viability of energy recovery?
27. What is sanitary landfilling?
28. Explain in details the hazardous waste management.
29. What is biomedical waste and what are the special measures to be taken in its management?
30. Write a short note on biomedical waste management.

**This page  
intentionally left  
blank**

### 5.1 INTRODUCTION

Ecology can be defined as the study of living organisms like plants and animals in relation to each other and the non-living environment in which they live. On the earth there are biotic (living) beings and abiotic (non-living) things. Both of them are in dynamic equilibrium with each other. The study of this interdependence and interrelationship is known as the ecology. The term ecology was coined by Reiter (1885) followed by Ernst Haeckel in 1869. Haeckel called the relation of the animal to its organic as well as inorganic environment Oikologie. Eugene Odum (1963) described ecology as 'study of structure and function of nature'. Charles Elton (1927) defined ecology as 'scientific natural history, The Indian scientists R. Mishra, G. Puri, S. C. Pandeya, Ramakrishnan and others started work on ecology in 1950.

Actually, the word ecology has been derived from two Greek words 'oikos' meaning house habitat or place of living, and 'logos' meaning study. Means it is the study of earth's house. The earth's house includes everything that exists on earth. Human beings and animals use nature for their growth and existence. In this process they use the natural gifts like sun, wind, water and the mineral resources of earth. Nature is not very comfortable in all conditions at all the places. Animals mould themselves according to the nature and live in the natural conditions as far as possible. Human beings try to mould the nature according to their whim and wisdom. Sometimes, it is within the earth's adjusting capacity, but many times it crosses it. Particularly these days the nature is on revolt. It is showing its displeasure by global warming, Al- Nino, Tsunami and other ways. That is why we have become so particular about the ecology. Some 50 years ago the human population of earth

was very less and the living style was so near to nature that it was used and not exploited. There is a large difference in use and exploitation. Now it is being exploited in want of more and more comfort. This over-exploitation of earth's natural resources has degraded, deteriorated or ruined the environment in which we live today. That has necessitated the study of ecology.

The field of ecology deals with the influence of different environmental factors on all the aspects of life like morphology, physiology, growth, behaviour and survival of the organisms. The surroundings of an organism affect the life of an organism. The white people in Europe and the blacks in Africa, all are human beings. The temperature, solar radiation, quality of water and the mineral resources influence the development of a species in a particular way. The interrelationship of ecology and environment has a very wide scope to consider. It has the structural components, biochemical cycles, bioamplification, toxic substances, detoxification, food and energy chains, different natural cycles like hydrological cycle, material cycles like the bio-geochemical cycles (nitrogen cycles, sulfur cycles) etc.

The environment has been classified as:

- (a) *Living or biotic environment*: It consists of plants, animals and micro-organisms.
- (b) *Physical or abiotic environment*: It consists of external physical factors like temperature, water, minerals, wind, gases and many types of radiations. Even the sound present in the atmosphere affects us. According to Indian philosophers the words, which we utter or pronounce, are Aksharas, means living for all times to come. So they are all present in the atmosphere in such a hidden form of energy that is still to be explored.

These constituents of environment are referred to as the environmental factors or ecological factors or just as factors. A factor is defined as an ecological condition which directly or indirectly affects the growth and development and hence the life of an organism.

This abiotic environment influences the biotic one and the living beings change, influence or deteriorate the non-living ones. For example we consume the food and after extraction of energy out of it we defecate the fecal material. That putrescible organic matter decomposes and gets stabilized into inorganic matter. This organic matter is taken up by the plants, trees in the form of minerals, nutrients, micro-nutrients and again they make the food for us. So there is a chain or a cycle in which the living and non-living beings are tied with each other. That is why we say that there is somebody (God) in every particle (living or non-living) in the same form, state, quantity, energy level etc. It is not so easy to understand all this but at least this should be understood clearly that everything on the earth is interdependent, associated with each other and we cannot live in isolation. This is the main fundamental of the study of science of earth i.e. ecology. Besides this philosophical aspect scientifically one has to study ecology for the following reasons.

### 5.1.1 Objectives of Ecological Study

- (i) To study the interrelationship between organisms in population and diverse communities.
- (ii) To study local and geographic distribution of organisms.
- (iii) To study the structural adaptations and functional adjustments of organisms to their physical environment.
- (iv) To observe the seasonal, annual, successional changes in the occurrence of organisms.
- (v) To study the eco- physiology i.e. the structural adaptations and functional adjustments of organisms to their physical environment.
- (vi) To study the productive ecology i.e. the biological productivity and energy flow in natural systems.
- (vii) To develop mathematical models to relate interaction of parameters and to predict the effects. i.e. simulation of various conditions and factors.
- (viii) To apply the knowledge gained by ecological study to safeguard against the disasters happening due to human activities like deforestation and environmental pollution, killing of animal life, chemical, biological or nuclear warfare, population explosion etc.

Before proceeding further let us understand some useful definitions in the field of ecology.

### 5.1.2 Useful Definitions

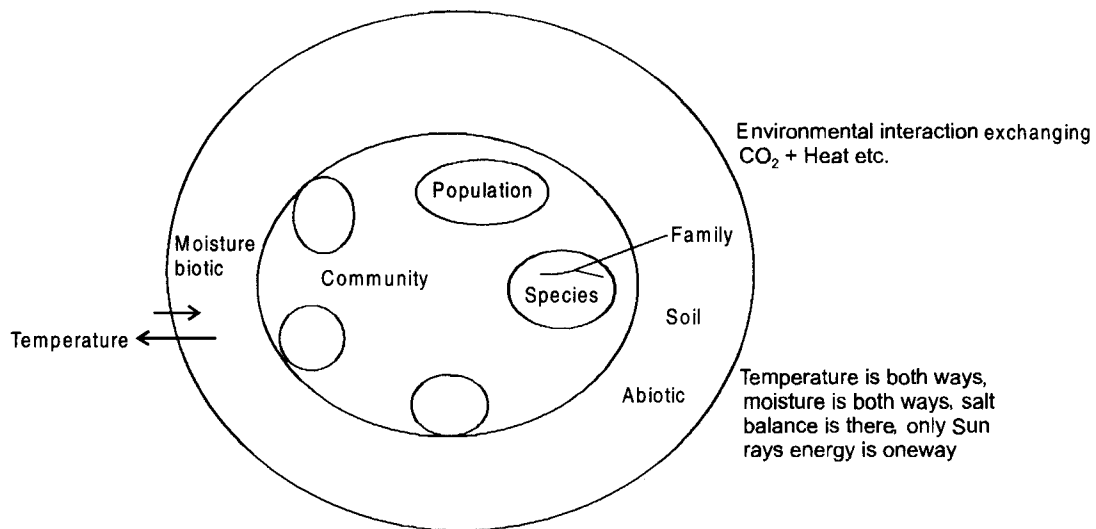

- (i) **Species:** It is a group of animals or plants subordinate in classification to genus and having members that can interbreed and that differ only in minor details for example our mankind.

- (ii) **Community:** A set of population living together in an environment is a community. A population of a single species cannot survive by itself because there is interdependence of one form of life on others. An aggregation of populations of different species living together in a specific area, having a particular set of environmental conditions constitutes a biotic community. The various plants and animals living in a lake are known as one biotic community whereas that living in a forest is a different biotic community. It may be further classified as major and minor community. A major community is a large community that is self regulating, self sustaining and independent unit comprising of many minor communities. For example a lake, pond, forest, desert are the major communities. The minor community is a small community that depends on other communities for existence. For example the forest has many minor communities like plant community, animal community and the microbial community. The animals depend upon plants for food and the plants depend upon animals for biological manure and for multiplication.
- (iii) **Niche:** Different species of animals and plants fulfill different functions in the ecological contest. The role of each species in an ecosystem is fixed and that is known as its Niche. Role means what it does, what it eats, who eats it where does it go i.e. the total range of its interaction with other species is the niche.
- (iv) **Habitat:** It is the requirement of residence item, i.e. range of temperature, moisture etc. It is the abiotic environment within a certain range of tolerance. Habitat is the surroundings in which a species live. Fish indicates the amount of dissolved oxygen. Trout (a fish) has a requirement of 13 p.p.m dissolved oxygen so must be a cold region. This is the habitat requirement of trout fish. The one which has widest range is the toughest one. Cockroach can live in a temperature range of  $-40^{\circ}\text{C}$  to  $+50^{\circ}\text{C}$  and without food for 3 months. Their tolerance against D.D.T (pesticide) is also very high. So they have a largest number on earth. According to E. P. Odum, habitat is the organism's address and niche is its profession.
- (v) **Ecosystem:** The community living with biotic and abiotic (non-living ) environment function together as an ecological system or "Ecosystem". For example terrestrial ecosystem, marine ecosystem etc. An ecosystem is defined as a natural functional ecological unit comprising of living organisms (biotic community) and their non-living environment that interact to form a stable self sustaining system. A pond desert, forest grassland etc. are the examples of the ecosystems. Ecology deals with species, organisms, populations, communities, ecosystems and biosphere. Population is defined as a group of individuals of any on kind of organisms. Community includes all the populations of a given area, called the habitat. Community and the abiotic environment interact and work together as a system called as the ecological system or the ecosystem.

The part of the earth where ecosystems operate is known as biosphere. Some natural ecological groupings of plants and animals based on regional climate and soil types interact and generate a characteristic land community or aquatic community, known as **biome**. The biosphere includes many distinct biomes like tropical evergreen forests, tropical and temperate deciduous forests, taiga (needle leaf evergreen coniferous forests), grasslands (prairies, plains, steppes, veldt), savanna, deserts, tundras, etc. and aquatic biomes like marine and large fish bodies. One can understand the biosphere to be a narrow sphere of earth where the atmosphere (air) hydrosphere (water) and lithosphere(soil) meet, interact, and make the existence of all types of life possible.

- (vi) **Population:** It is the total assemblage of interbreeding individuals of a given species found in any ecosystem under study. A species may have many populations. The properties of population include abundance and population densities, range genetic variability, adaptations, resource needs and other demands on the environment and factors that influence population growth, birth and death rates and age distribution, i.e. population dynamics.
- (vii) **Environment:** Environment comprises of the several interrelated and dynamic factors, some of which become critical in the growth, development and multiplication of the organisms.
- (viii) **Organisms:** The different types of organisms living in a particular environment are not only independent and mutually reactive but also react with the environment. The organisms have sufficient plasticity to modify themselves according to changing environment by modifications in somatic (physical) structures (ecads) or genetic characters (ecotypes).
- (ix) **Succession:** The changing environment leads to the exit of pre existing species when it does not suite them, and invasion of new and more vigorous species, resulting in plant succession. The process continues till the development of a new stable and adjustable for equilibrium community. The final stage of developed community is called a climax community.
- (x) **Biome:** The complex of several communities in any area , some at climax and others at different stages of succession, under same climatic conditions is known as a biome.

### 5.1.3 Classification of Various Aspects of Ecology

Two important aspects of ecology are autecology and synecology.

**5.1.3.1 Autecology:** It is associated with the ecology of an individual species and its population. It is the study of a particular species and its behaviour and adaptation to the environmental condition at every stage of that individual's life cycle. Autecology is also called species ecology.



**5.1.3.2 Synecology:** It is the study of communities, their composition, their behaviour and relation to the environment. Synecology is also called as the ecology of communities and further divided in three fields:-

- (a) Population ecology
- (b) Community ecology
- (c) Ecosystem ecology

**5.1.3.3 Classification on the Basis of Habitat**

- (a) Aquatic ecology
  - (i) Marine ecology
  - (ii) Freshwater ecology
  - (iii) Stream ecology
- (c) Terrestrial ecology
  - (i) Grassland ecology
  - (ii) Forest ecology
  - (iii) Desert ecology

*5.1.3.3.1 Modern sub-divisions of ecology:* As stated earlier the broad classification of ecology is autecology and synecology. Autecology is the study of individual organisms or species in relation to environment. Synecology studies the groups of organisms which are associated together as a unit in relation to the environment. Referring the ecological studies particular to animals and plants it can be broadly divided into animal and plant ecology. Following are some branches of ecology:

- (i) **Habitat ecology:** It includes fresh water ecology, desert ecology, forest ecology, grassland ecology, marine ecology etc. depending upon the nature of residence. i.e. habitat.
- (ii) **Population ecology:** It is the study of inter-relationships of different groups of organisms. It also includes the study of number of organisms and their distribution.
- (iii) **Conservation ecology:** It includes the proper management of natural resources like water, land, forest, mines, oceans etc. for the benefit of mankind.
- (iv) **Ecosystem ecology:** It is the structural and functional analysis of ecosystems including the inter-relationship of biotic and abiotic components.
- (v) **Production ecology:** It is a comparatively new branch that deals with the gross and net production of different ecosystems like fresh water, agriculture etc. for the proper management to get maximum yield.

- (vi) **Radiation ecology:** It is the study of radioactive substances, radiation and the environment. The development of nuclear energy and its impact on environment has necessitated this branch of ecology.
- (vii) **Palaecology:** It deals with the organisms of past ecological environment and traces the gaps in the evolutionary lines and place and time of various groups of plants and animals.
- (viii) **Ecological energetics:** It is a recent branch dealing with energy conservation and energy flow in the organisms within the ecosystem.
- (ix) **Gene ecology:** It is the genetic make up of species or populations in relation to the environment. It gives a valuable and reliable data on the origin and inheritance of adaptations in plants and animals.
- (x) **System ecology:** It is the research of the community dynamics abstracted to a mathematical level, where one summarizes the complex formulations and simulates and model the required dynamic systems under examination.

#### 5.1.4 Functional Concepts of Ecology

Alongwith the various definitions and the classifications it is beneficial to know the functional concepts of ecology that are as follows:

- (i) **Ecosystem:** The basic structural and functional units of nature are ecosystems. An ecosystem is a biotic assemblage of plants, animals, and microbes, taken together with their physico-chemical environment.
- (ii) **Ecological niche:** Every biological community consists of a number of organisms or populations, which occupies a specific volume of the habitat circumscribed by the interaction of various factors and trophic levels of the organisms. This is called as the ecological niche.
- (iii) **Population interactions:** The degree of success of a particular population in a habitat is determined by the parameters of both biotic factors as well as interaction with other types of populations. This interaction may be negative, positive or neutral.
- (iv) **Flow of energy:** The flow of energy in the ecosystem is unidirectional or non-cyclic. Radiant energy (of solar radiation) is trapped by autotrophic plants or primary producers that transfer it to the consumers and decomposers. Some loss of energy takes place in transfer from one trophic level to the other, e.g. in the respiration by the organisms etc.
- (v) **Biogeochemical cycling:** The chemical components of the ecosystem move in defined cycles, which are regulated by the biological cycles.
- (vi) **Limiting factors:** Successful growth of the organisms is governed by limiting factors. For this an organism requires various essential factors from its environment. The levels of tolerance for all ecological factors of a species vary seasonally, geographically and according to the age of the population.

- (vii) **Climax:** The populations undergo succession under natural conditions. Ecosystems undergo an orderly process of change with time, passing from a less complex to a more complex state. This involves not only the changes in species composition but also changes in the physical environment of a community. The stabilized state is known as the climax.

## 5.2 BASICS OF SPECIES

As defined earlier species is a group of animals or plants subordinate in classification to genus and having members that can interbreed and that differ only in minor details. Each species has unique morphological, physiological and behavioral attributes. The combination of these attributes is known as ecological niche. The ecological niche is its role in an ecosystem that is what it does, what is done to it and where it is. Some species are the energy source only to some selective species whereas there may be some to serve so many other species. Some plant species are more efficient in capturing energy at some particular altitude or at some depth in the aquatic ecosystem than the others. So the working of species is time specific and place specific. Two ecosystems may look alike due to the same species but as the working of the same species is different in different situations so every species has a specific role (niche) in an ecosystem.

The important things in the complete ecological life history of a species are :

- (i) Phylogenetic (history of evolution of animals or plants) and geological history.
- (ii) Geographic and habitat distribution with an adjustment to the physical environment and of biotic inter-relations within the community.
- (iii) Variations in population through time and in space.
- (iv) Changes in seasonal activities and physiological states like breeding, development, multiplication and migration.
- (v) Food, mate and shelter.
- (vi) Parasites, diseases. ailments
- (vii) Reproductive potential, mortality rate.
- (viii) Requirements of reproduction like home, territory, segment, nesting material etc.
- (ix) Breeding behaviour, mating etc.

## 5.3 ECOSYSTEM

The ecosystem comprises of the biotic community and the non-living environment. It is the basic functional unit as it includes both the organism and its environment, each influencing the properties of the other and both required for the survival and maintenance of life. Some examples of natural ecosystems are lakes, ponds, oceans, grasslands, forests, deserts, etc. No ecosystem can stand without its surroundings. A pond is surrounded by some other ecosystem say field. Organic matter may be added to the pond from the field. Human intervention is always there to disturb the identity of an

ecosystem. Sewage is discharged in a pond lake or the river and ultimately the sea. These complex feeding relationships often results in biological transfer of nutrients and energy between the ecosystems. So it is not possible to study an ecosystem in isolation and one has to take care of their continuousness. So if we consider all of them as interconnected and interrelated, this gigantic network of ecosystems constitutes the outer layer of the earth known as the ecosphere or biosphere. However, each ecosystem is an open one and depends upon outside factors such as the radiant energy of sun (with the exception of some, like the cave ecosystem). So it can be concluded that the ecosystems are self sustainable, self regulatory from inside but affected and interrelated with outside environment also. This is like a village that may be self sufficient but dependent upon the state for communication, safety and other such requirements.

Every ecosystem has the following components:

- (i) **Abiotic environment:** The non-living environment such as the air water soil and the basic elements and compounds. These non-living substances enter the body of living organisms, take part in metabolic activities and come out. This portion of the ecosystem can be further divided in three parts:
  - (a) The climatic regime and physical factors like temperature humidity etc.
  - (b) Inorganic substances such as water, carbon, nitrogen etc.
  - (c) Organic substances like fat, proteins, carbohydrates etc. which are the part of living bodies and are the links between the biotic and abiotic components.

The climate and soil largely determine the diversity of organisms present in terrestrial ecosystems. Temperature, salinity, dissolved gases, chemical substances, nutrients etc. determine the species diversity in aquatic ecosystem. Climatic conditions and other factors vary substantially from the arctic region to the tropics, and thus highly affect the distribution of organisms.

- (ii) **Producers:** The energy transducers which convert solar energy into chemical energy with the help of water and carbondioxide and organic substances such as enzymes are called as producers. These producers are autotrophic means self-nourishing. Producers are mainly green plants like trees, grass, crops and small phytoplanktons. They have a green pigment called chlorophyll that transducts (converts) solar energy. These autotrophs are called photoautotrophs because they utilize light energy. The chemoautotrophs use the energy generated in an oxidation-reduction process but are less important. Micro-organisms like Baggiatoa and the sulfur bacteria are examples of chemoaitotrophs.
- (iii) **Consumers:** These are the heterotrophic (hetro = others, trophic = nourishing) organisms mainly the animals including the human beings. Consumers are called as herbivores if they are plant eaters and carnivores if they are flesh eaters like lion tigers etc. Herbivores may be insects, zooplankton, or animals like deer, cattle etc. Carnivores prey on herbivores and other carnivores. Human beings are both herbivores and carnivores.

- (iv) **Decomposers:** These are also heterotrophic organisms but depend upon dead animals (organic matter) for their food. They are mainly microorganisms like bacteria, actinomycetes and fungi. They break down complex organic matter like cellulose, proteins etc. found in the plant and animal body into simple substances used by the producers. There are some invertebrate animals like protozoa, oligochaetes like earthworms etc. that use the organic matter for their food. They have the requisite enzymes and hence can be classified as the decomposers. Sometimes they are termed as the secondary decomposers.

Like this the ecosystem has mainly two biotic components-autotrophic and heterotrophic. Heterotrophs can be herbivores, phagotrophs (animal ingesting) or saprotrophs (sapro = to decompose). This classification is based upon the trophic function. Some organisms may have trophic characteristics that lie in between those of phagotrophs and saprotrophs. Any self-sustaining unit of the nature can be recognized as ecosystem if it has these four components, namely abiotic substances, producers, consumers and decomposers. The agriculture system is a man-made ecosystem and has to prove itself close to nature in a long run of time. Many environmentalists criticize it because of the deforestation it has caused.

### 5.3.1 Cyclic Operation of Ecosystems

Earth is a closed system as far as mass is concerned. Energy is open system, everyday added up, depending upon the distance from equator. These are the main components of the cyclic operations in an ecosystem:-

- (i) Geophysical
- (ii) Hydrological
- (iii) Chemical
- (iv) Biological

Some of the important cycles are as follows:

#### 5.3.1.1 Geophysical

The earth's physical cycles are the geophysical cycles. The core of the earth is a molten mass and the crust has land sea and ice. Movement, i.e. drifting of crust takes place. Millions of years ago Himalaya was in Africa. 5 cm/year we are moving far away from equator. Some say that landslides in Himalayas is due to deforestation but actually it is a natural process. Volcanoes come out. Aggradations is building up of mountains, degradation is leveling up. Fluvial geomorphology suggests that the tendency is to come to a mean level. The various morphological agents are the tectonic movements, earthquakes, volcanic eruptions, water, wind and temperature. The combined effect is cyclic in nature.

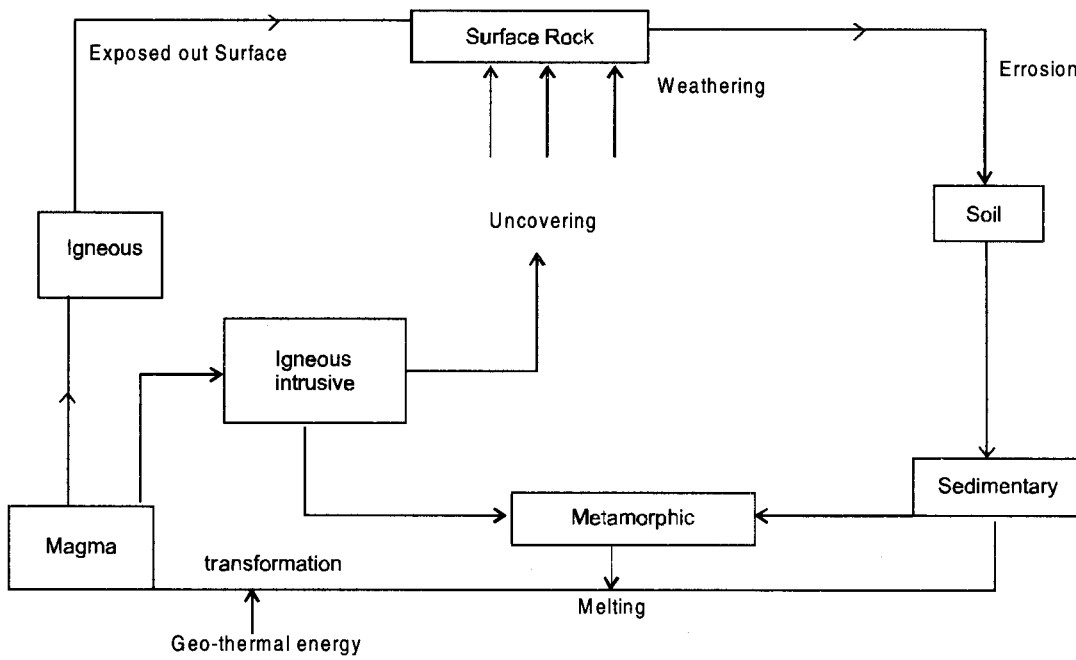

**Geological Cycle**

**5.3.1.2. Hydrological cycle**

It deals with water after touching the surface, that how does it make a cycle

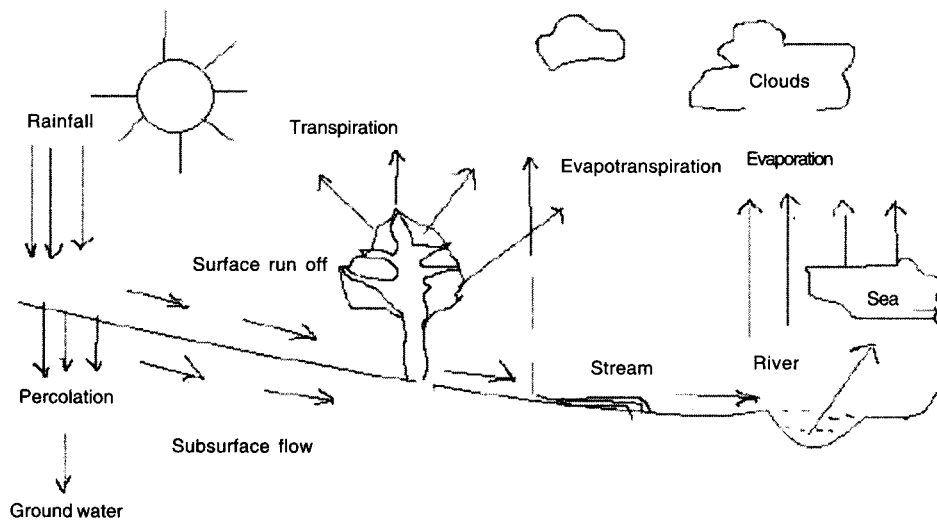

**Hydrological Cycle**

Sun is the main source of energy in the hydrological cycle. The rainfall takes place in many forms like orographic, cyclonic (coastal areas) and convective (only in hours) depending upon many climatic factors. The rainfall infiltrates the earth and percolates to meet the groundwater. A large portion of it flows on the earth known as the surface run-off and appears as the rivers. Some of the water flows below the ground surface and depending upon the levels sometimes comes out as the falls etc. The streams and rivers meet the sea that is a large storage of water though saline. The water evaporates from every surface wherever it is exposed to sun rays or the heat produced by it. The subsoil water is pumped through the roots of the trees and then by the transpiration from its leaves etc. to the atmosphere. The clouds so formed travel due to the difference in air pressure levels throughout the earth for the whole year. Depending upon the various climatic factors the precipitation (rainfall) again occurs for the new cycle. Trees play a very important role so let us have some more emphasis on the trees.

### ***Importance of Trees***

Trees are useful in the following ways:

- (i) They consume the carbondioxide in the presence of sunlight and make oxygen. Oxygen is already abundant in the atmosphere but this reduction of  $\text{CO}_2$  is much more important as the  $\text{CO}_2$  is the main culprit of Global warming. The global warming is harmful in so many ways like increasing the sea level by melting of polar ice resulting in the drowning of many cities. It is leading to uncomfortable temperatures and increase of vector borne diseases.
- (ii) They produce many useful products like fruits, wood, timber, fiber, gum, herbs, and other eatables.
- (iii) They absorb the subsoil moisture that is of no use and pump it to the atmosphere by transpiration. This increases the relative humidity (R.H.). Relative humidity is the ratio of available moisture present at any temperature to the maximum moisture the air can contain (hold) at that temperature. For example if air can contain 3 grams of water at  $20^\circ\text{C}$  at saturation and if there is 1.5 gm of moisture present in some air sample at  $20^\circ\text{C}$  it shall be termed as 50% R.H. Means the desire of moisture is 50% satisfied only. Now when the clouds come and the air in that area has only 50% R.H. most of the water present in the clouds may be exhausted to bring the R.H. to 100% so that precipitation may start. In some cases there may be no rainfall in such case. Had the R.H. of that air been 90% (say improved by the trees) there would have been rainfall. Like this the trees are helpful in rainfall.
- (iv) Roots of the trees hold the soil firmly. In desert areas where high velocity wind blows the trees stop the movement of soil by holding it firmly and by decreasing the velocity of winds. Thus the trees stop desertification.



- (v) At the time of rainfall the canopy of the trees hold the drops of the rainfall and reduce their momentum and thus reduce the erosion of soil. They also delay the rain from reaching to the earth and thus reduce the flood intensity. At the time of flood they reduce the velocity of storm water and thus the soil erosion and other destructions.
- (vi) They absorb the air polluting gases like SO<sub>x</sub> and NO<sub>x</sub> and the S.P.M. The leaves of the trees get damaged by these air pollutants but they clean the air and thus help us.
- (vii) They consume the sound waves and thus reduce the noise pollution. Noise pollution has become a menace these days and trees provide a simple solution to it.
- (viii) The increased moisture due to transpiration reduces the temperature substantially and thus gives relief to us in hot and dry climatic conditions. The cover of trees on the west side of a house restricts the direct sunlight to the walls and thus reduces the heat transfer to the inside of house and thus reduces the air conditioning load.
- (ix) The trees provide a smoothening effect to our eyes. It reduces the atmospheric glare and gives us a feeling of protection and comfort. The green canopy of the trees assure us about the food, shelter and prosperity.
- (x) Trees provide shelter to every type of animal and birds particularly. The birds and other animals are the parts of different chains and the trees are the natural habitat for them.

Although some scientists sometimes say that 'Planting trees won't check warming' Times of India news on April 13, 2007. As per the news item it was revealed in a research paper published in the proceedings of the National Academy of Science that adding new forest areas in regions like India may not do much to reduce global warming. They say that ecology is about a fine balance and it could harm to force it in one or the other direction-to cut too much or grow too much forest. As per the news the research paper suggests that afforestation may be good idea where man has earlier caused deforestation but one should not try to put forests where it is not naturally supposed to be, say in grassland or a high -altitude pastureland. Actually, in India 33% land was under forest at the time of independence that has reduced to about 11% only. So we are ought to recuperate this loss in any case. Secondly, it is not only the global warming trees has numerous benefits as listed above. So one must plant, grow and take care of trees.

Before proceeding to the other cycles let us have a look on basic building blocks in tissue building. To build, hydrogen (H), carbon (C), nitrogen (N) and oxygen (O) are required. To sustain it the macronutrients like Na, Mg, P, S, Cl, K, and Ca are required. Various micronutrients are also there as F, Fe, Se, Si, Co, Mo, Cu, Su, Cr, Zn, I and Mn. These micronutrients are essential but marginal overdose will be toxic. The cyclic exchange of nutrient material between the living organisms and their non-living environment is known as biogeochemical cycle. The nutrients circulate through life (bio), through earth (geo) and repeatedly means cyclic.



5.3.1.3 Chemical cycle

There are many chemical cycles like carbon, nitrogen etc.

(i) Carbon Cycle

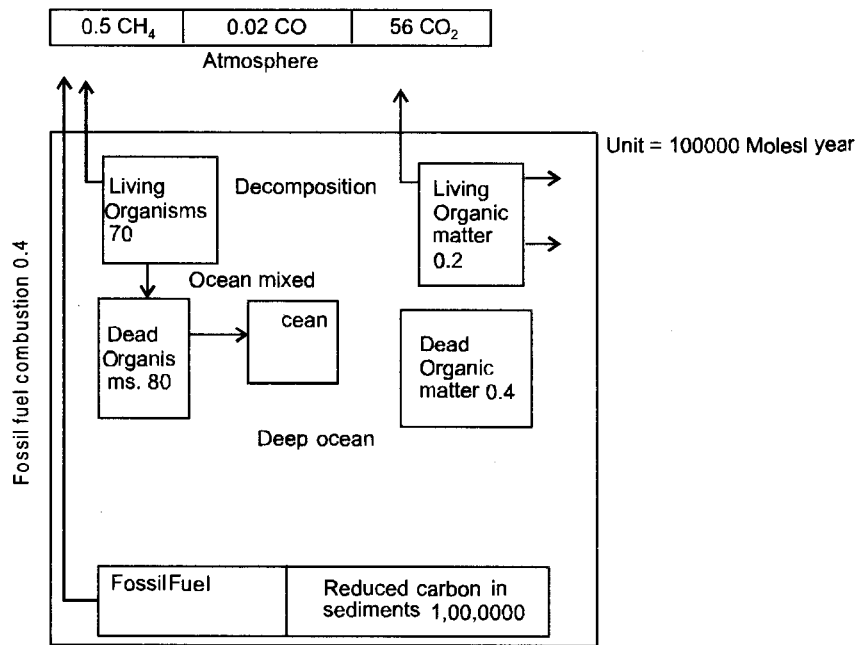

Global Carbon Cycle

The CO<sub>2</sub> enters the living world through photosynthesis. Plants synthesize the organic compounds and the consumers use them. The plants, animals release carbon back to the atmosphere in the form of CO<sub>2</sub>. The dead bodies of animals and rotten plants also release CO<sub>2</sub> by aerobic decomposition. This is shown diagrammatically as below:

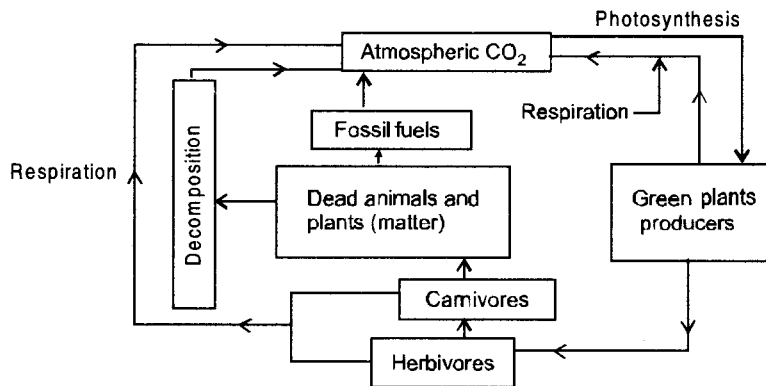

Carbon Cycle

(ii) Nitrogen Cycle

Nitrogen of the atmosphere can not be used by the plants directly. It has to be combined with other elements (fixed) and then used by the plants. The denitrifying bacteria releases it to the air and it comes back through the action of lightening and electrification. The cycle is as shown below:-

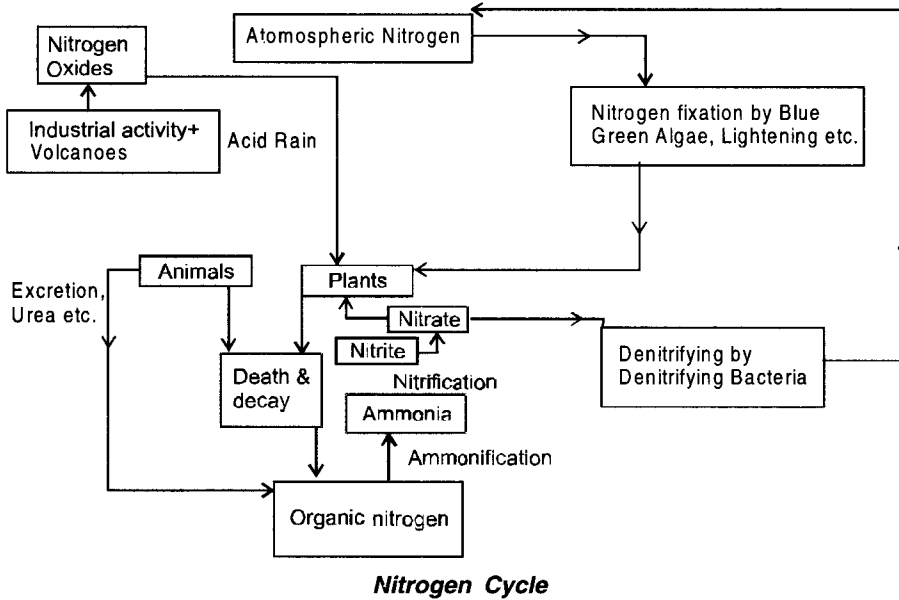

Sulphur cycle

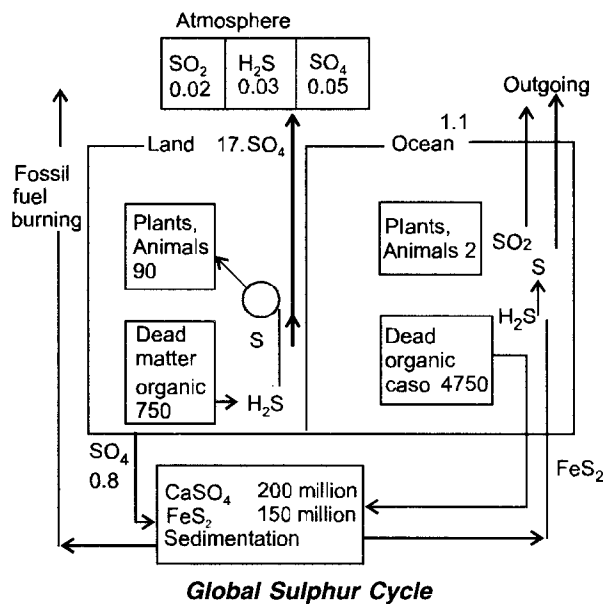

## (iv) Phosphorus Cycle

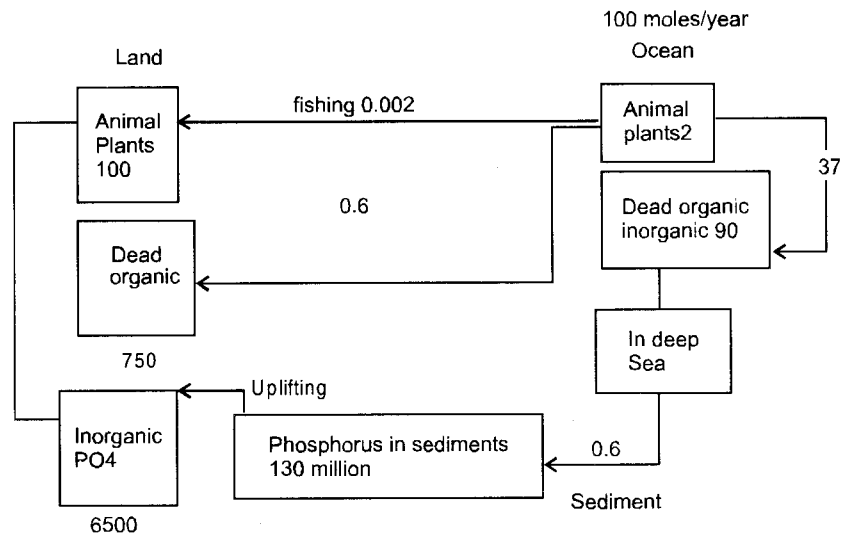
*Global Phosphorus Cycle***5.3.2 Ecosystem and Human Beings**

As explained earlier an ecosystem is a biotic assemblage of plants, animals and micro-organisms, taken together with their physico-chemical environment. The biological cycling of materials takes place by the producers, consumers and decomposers (also known as recyclers). Various bacteria like aerobic, anaerobic, facultative bacteria and fungi decompose the organic matter of producers and consumers into inorganic matter that can be reused as manure (food) by the producers. Thus, decomposers are the recyclers of the biosphere. Sun is the ultimate source of energy and nature is capable of maintaining the producer-consumer-decomposer cycle for indefinite time with the sun's energy. Unfortunately human activities disturb the natural cycles. The major human activities are:

- (i) Production activities like energy production (fossil fuels), manufacturing and growing food.
- (ii) Consumption of the produced energy, goods and the food by the human beings and the domestic animals.
- (iii) Decomposing or recycling activities like treatment of wastewater, recycling of metals and solid waste.

The ecosystem relies on its decomposers for a complete recycling of its elements but anthroposystem (system originated by man) lacks such efficient decomposers and recyclers. For example the plastic made by the human beings is generally non-biodegradable. As such the waste and unwanted by products of industrial activity are largely disposed into the physical environment. **The process of adding unwanted materials to the environment is known as pollution.**

In an ecosystem most of the material is transferred from the producers (plants) to the recyclers (bacteria), and only a small fraction is passed through the consumers to the recyclers. The decomposers return most of the material to the producers for reuse. In the manmade ecosystems (like agriculture) the flow from the producers to the recyclers is small since it is not worthy to produce materials (products) and immediately recycle them without consumption. So in the anthroposystem much of the material is transferred to the rest of the material environment, to the producer and to the consumer. Hence, it is mostly an open system with a very less recycling of the mobilized matter.

The second difference is the close physical proximity between the producer and the consumers. This requires a very small amount of energy for the physical transport of matter between the plant and its symbiotic bacterial population.

In the anthroposystem, there is a significant displacement between the producer and the consumer. The flow of oil on the earth is a good example. A significant amount of energy is required to transfer the matter to the consumer. This physical separation of the three components of an ecosystem is the major difference between the ecosystem and the anthroposystem.

### 5.3.3 Biome and Ecosystem

As stated earlier a biome is a large area with similar flora, (plants) fauna (animals) and micro-organisms. Following are some of the major biomes of the earth:

- Mountains
- Tundra
- Marine/Island
- Desert
- Temperate Forest
- Tropical Dry Forest
- Tropical Rainforest
- Cold Climate Forest
- Grassland
- Savannah

The ecosystems are smaller than the biomes as a biome can be considered as a group of many similar ecosystems. However the ecosystem may be as large as the Sahara desert and as small as a puddle (small dirty pool of rain water).

The existence of an ecosystem depends upon the balance between the available food, water and shelter and the demand of the organisms. Food and territory are often balanced by natural balancing phenomena such as fire, disease, epidemic, disasters and the number of predators. In maintaining this balance every organism has its role to play and as such even if a single species is extinct the whole chain gets disturbed. That is why we have tiger and other sanctuaries to save the endangered species. But we have disrupted the natural cycles and food chain in want of the urbanization and industrialization that most

of the ecosystems are in danger. Most of the human activities like agriculture (deforestation), mining, industrialization are against the natural balance of ecosystems and the system is on the verge of failure. It is the duty of every citizen to safeguard the environment to save this mother earth, to save ourselves, and the main aim of this text.

#### 5.4 ENERGY FLOW IN THE ECOSYSTEM

Sun is the basic source of energy. All the biological activities involve the radiant energy of the sun. The solar energy is transformed from the radiant to the chemical form in photosynthesis and gets converted from chemical to mechanical and ultimately heat form in cellular metabolism.

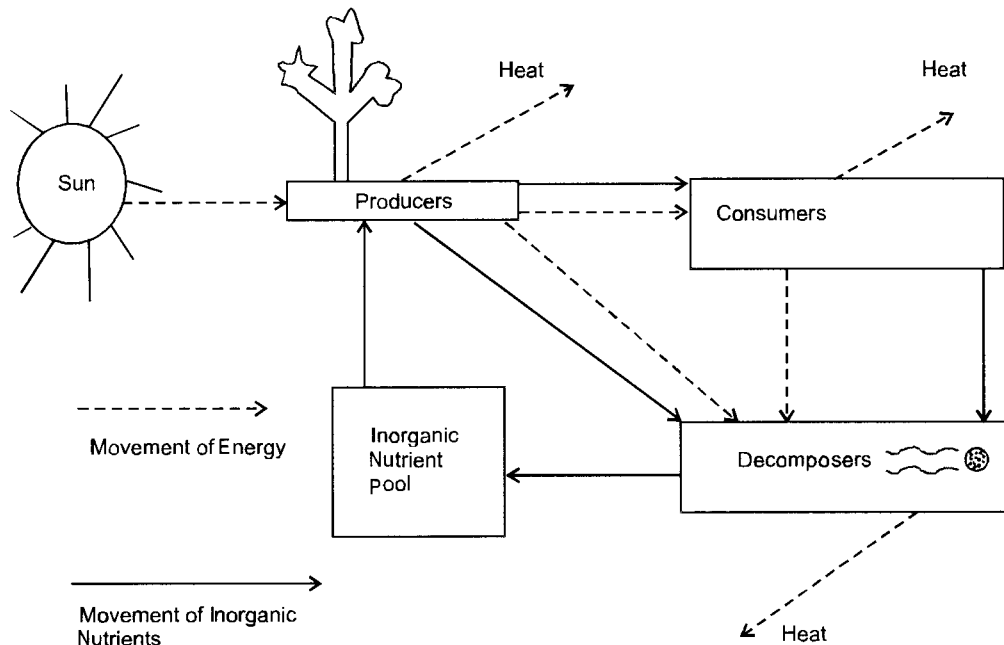

**Energy and Nutrient Flow Through Ecosystem**

The above figure shows the flow of energy and the inorganic nutrients through the ecosystem. Actually, the energy travels or flows through the ecosystem in the carbon-carbon bonds. Due to respiration the carbon-carbon bonds are broken and the carbon is combined with oxygen to form carbon dioxide. Energy is released in this process that is either used by the organism for its movement, food digestion, excretion etc, or the energy may be lost as heat. The dotted lines show the movement of this energy. Sun is the only source of energy and the fate of all energy in the ecosystem is to be lost as heat and thus the flow of energy is unidirectional and it does not recycle.

The other components shown above are the inorganic nutrients. They are inorganic because they do not have carbon-carbon bonds. These nutrients include the phosphorous

in our teeth, bones etc; the nitrogen in our amino acids that is a building block of protein; and the iron in our blood. The autotrophs obtain these inorganic nutrients from the pool that is usually soil or water surrounding the plants. These inorganic nutrients travel from one organism to the other as one is consumed (eaten) by the other. Ultimately all organisms die and become food for the decomposers. At this final stage the energy is extracted, and lost as heat and the inorganic nutrients are returned to the soil or water to be reused again. So it means that the inorganic nutrient are recycled but the energy is non-recyclable.

**5.4.1 Solar Energy**

The sun is actually a thermonuclear reactor in which hydrogen is transmuted to helium with a simultaneous release of radiant energy in the form of electromagnetic waves. This radiation contains high frequency, short-waves X-rays and gamma rays to low-frequency, long-wave radio waves.

Solar energy is replenished daily at different rates in space and time. It depends upon latitude and day of the year. Light is an electromagnetic radiation. Energy is classified in terms of wavelength, it may be in microns or in meters.

$$\begin{aligned} \text{Speed of wave} &= \text{Speed of light} \\ &= 300 \text{ thousand Km/sec} \\ &\quad (1,86,000 \text{ miles/sec}) \end{aligned}$$

The following sketch shows the part distribution of solar radiation

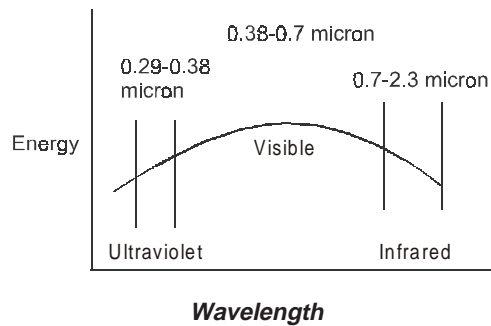

The following table shows the wavelengths of different of Radiations

**Table 5.1 Wave lengths of different Radiations.**

<b>Type of radiation</b>	<b>Wavelength</b>
Radio	1- 10 m
Microwave Radar	1- 30 cm
Infrared	0.71- 100 micron
Visible	0.41- 0.71 micron
Ultraviolet	0.1- 0.4 micron
X-rays	10 <sup>-5</sup> – 10 <sup>-2</sup> micron

The following table shows the absorption of solar radiation by different molecules at different levels

**Table 5.2 Absorption of Solar Radiation**

<b>Micron ( <math>\mu</math> )</b>	<b>Absorbed by</b>	<b>At height</b>
< 0.12	O <sub>2</sub> and N <sub>2</sub>	100 Km
0.12–0.18	O <sub>2</sub>	50 Km
0.18–0.30	O <sub>3</sub>	25–50 Km
0.3–0.34	Partly by O <sub>3</sub>	25–50 Km
0.34–0.4	Transferred to earth	

Energy percentage at outer atmosphere

Visible spectrum	41%
Infrared	50%
Ultraviolet	9%

Visible = Transferred to earth

Infrared = Absorbed by clouds etc.

Approximately 99% of the total energy is in region of wavelengths from 0.136 to 4 microns ranging from ultraviolet to near infrared. It is interesting to note that about half of this energy is in range of visible spectrum i.e. 0.38 to 0.77 microns. As the earth is a tiny planet far away from the sun it receives only about one fifty-millionth of the sun's radiant energy at its outer atmosphere. This is known as the extra-terrestrial radiation and amounts to about 1360 W/m<sup>2</sup> instantaneously. Half of this is depleted because of the absorption and reflection etc. as it passes through the troposphere. As the earth is inclined to its orbital plane and the revolution of the earth around the sun, the instantaneous solar radiation (flux) varies seasonally with latitude. As the earth rotates this flux at a given place changes with time, day and night (diurnally) also. The absorption/reflection of the solar energy depends upon the density of cloud cover. The pollutants like S.P.M. and smoke etc. also decrease the flow of light to earth. The radiant energy absorbed in the troposphere is radiated in all directions in the far infrared portion of the electromagnetic spectrum. Its some portion strikes earth and gets reradiated. The direct solar radiation and the infrared radiation heat the air near the earth and soil and water on it. The visible portion of this radiation activates the photosynthesis. The measurement of the amount and rate of energy fixation is based on the photosynthetic equation

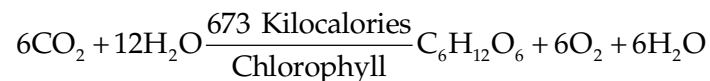

Knowing the amount of one component the amount of the other can be calculated.

This analysis is done to know the efficiency of the ecosystem. Actually in general about 1 to 5% of the solar energy is converted to organic matter that structures and operates the solar-powered ecosystem.

The sequence of solar flow with approximate figures just to show the depletion at various levels is diagrammatically shown below with an initial value of say 5.25 million Kcal /year per square meter.

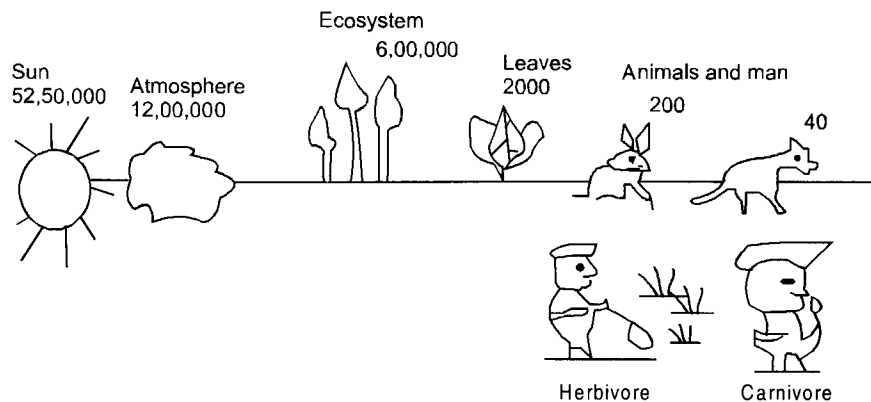

**Solar Energy Flow in Kcal/square Meter Per Year**

This shows the manner in which energy flows through the ecosystem. It is important that the materials (non-energy yielding) circulate but energy does not circulate. Energy is used only once by a given organism then converted into heat and lost from the ecosystem. The carbon, nitrogen, oxygen, hydrogen etc. circulate many times between biotic and abiotic entities again and again. This one way flow of energy, is the result of the operation of first law of thermodynamics. The first law states that energy is never created nor destroyed, but may be transformed in one form or the other. The second law of thermodynamics states that no process involving an energy transformation will occur unless there is a degradation of energy from a concentrated to a dispersed form. Now as some energy is always lost into unavailable heat energy no transformation can be 100% efficient. The second law of thermodynamics is also known as the law of entropy. Entropy is a measure of disorder in terms of amount of energy lost in a closed thermodynamic system. So although the energy cannot be created or destroyed it is degraded when used to dispersed heat.

The interaction of energy and materials in an ecosystem is of great concern to an ecologist. The one way flow of energy and the cyclic flow of materials are the two important concepts of ecology as they are universally applicable to all environments and all organisms. Also it is noteworthy that the flow of materials also requires energy and energy is not recyclable.

## 5.5 MAJOR ECOSYSTEMS OF THE WORLD

When the earth was formed and the water on it was concentrated in the seas, the life started from them only. So let us start with the sea as the most primitive ecosystem.



### 5.5.1 Sea as an Ecosystem

About 70% of the earth is covered by the major oceans namely Atlantic, Pacific, Indian, Arctic and Antarctic. Waves, tides currents, temperatures and pressures etc. determine the biological community in each ocean. These factors decide about the bottom sediments and the gases in solution. The food chain of the sea comprises of small autotrophs to large creature like whale. The seas are the largest and thickest of ecosystems since every square meter of sea has so many type of life forms and even the deep sea contains life. The main important characteristics of marine environment is the salinity. The salt concentration of a sea is usually 3.5%, mainly the sodium chloride. This concentration varies with depth and latitudes. It is lesser near the poles and the estuaries. Phytoplanktons like the diatoms, dino flagellates and algae are the primary producers. Some macroscopic seaweeds such as brown and red algae also contribute in the production of food. Herbivores like crustaceans, mollusks fishes and other aquatic animals are the primary consumers. Various species of fish such as Herring etc. are the carnivores. Fishes like cod, shark and whale survive on the smaller carnivores. Bacteria and some fungi are the usual decomposers.

### 5.5.2 Estuaries

The portion between the seas and continents is known as the estuary. So the estuary is an area at the mouth of a river where it meets the sea. They have a diverse ecosystem of their own which is different than the both. Salinity and temperature are the most important physical features. As it has an advantage of both conditions so it has such species that are neither there in the sea nor in fresh water. The estuaries are rich in nutrients and generally have three major type of life forms. First is phytoplankton, second is benthic microflora like algae and third is the macroflora like the seaweeds, emergent marsh grasses etc. Generally it is the estuary that has to bear with the manmade pollution.

### 5.5.3 Streams and Rivers

They are the flowing fresh water bodies. Though a very small amount of the total water (0.0001%) flows in the rivers, they are the lifelines for the human civilization. All the early civilizations started on the banks of rivers. Although the total area of the rivers is much smaller than the seas, they are the most useful ecosystems for the human beings. The rivers are used for water supply, waste disposal, fish production, navigation, electricity production etc. However they have to borrow organic matter from adjacent terrestrial ecosystems, or sometimes from adjacent lakes. The sewage and solid waste discharged into the rivers has polluted almost all the rivers of the world.

The river water differs in quality and quantity depending upon its origin and the area through which it passes. The plankton population is scarce in the river water originating from the glaciers with rapid currents of cold water. In its middle reaches the water absorbs more and more heat from sunlight and due to photosynthesis the biological activities become dominant. The sediment transportation and deposition

takes place. In the lower reaches in plains the velocity further reduces and both phytoplankton and zooplankton flourish. Various species of reptiles, mammals and birds are fed upon the rivers.

#### 5.5.4 Lakes and Ponds

These are the stagnant bodies of fresh water (sweet, surface water). The lakes and ponds are comparatively younger in age. The abiotic factors of a pond or lake depends upon location and the surrounding ecosystem. In some rare cases the lakes may have saline water as the Sambhar lake of Rajasthan that is used for manufacturing of common salt. Generally, the species diversity is low in fresh water system. Distinct stratification and zoning are characteristic features of lakes. Typically a littoral zone containing rooted vegetation, a limnetic zone of open water dominated by plankton, and a deep water profundal zone containing heterotrophs. Also the lakes become thermally stratified in winters and summers.

#### 5.5.5 The terrestrial Formations

Big terrestrial community units are known as biomes. In a given biome the life form is uniform, thus the dominant climax vegetation in the grassland biome is grass. Depending upon the mean annual temperature range the terrestrial ecosystems has been classified as

- (i) Arctic and Alpine Tundra
- (ii) Coniferous Forest
- (iii) Deciduous Forest
- (iv) Tropical Forest
- (iv) Grassland
- (vi) Desert

There are some other biomes like chaparral, tropical savanna, thorn shrub and tropical monsoon forest.

#### 5.5.6 Deserts

These are the biomes with less than 250 mm of annual rainfall. Deserts have about 17% of the total land area on the earth. Lack of rain in the mid latitudes is due to stable high pressure zone. Generally, the deserts lie in "rain shadows" i.e. where high mountains block off moisture from the seas. The rain fall in deserts is low and the evaporation rate is high. Even the small rainfall is also useless as the water quickly penetrates the soil and goes deep inside it. Some of the main deserts of the earth are in south western united states, Mexico, coastal areas of Chile, central western Australia, Asia (Thar, Gobi etc.) The desert may be a cool one like that in Washington and a hot one like that in Arizona. Generally, there are four distinctive life forms in the deserts:

- (i) The annuals like cheat grass that avoids drought by growing only when there is sufficient moisture.
- (ii) The desert shrub with numerous branches and small thick leaves. Sometimes with deep roots to absorb moisture and store it before wilting.
- (iii) The succulents, such as cacti that store water in their tissues.
- (iv) Microflora such as mosses, lichens and blue green algae that remain active less in the soil in want of favourable conditions.

The productivity of a desert is a linear function of rainfall. It may be as less as 600 Kg dry matter per hectare to 2000 kg per hectare depending upon the rainfall. Irrigation can increase the production manifold as the soil is generally fertile. But how long it can sustain it depends upon many factors and the human wisdom. The major irrigation projects like Indira Gandhi Main Canal (600 Km long ) has converted the Thar desert of western Rajasthan into a good productive area in its command.

### 5.5.7 Tundras

Tundras are barren grounds with very less biological productivity because of the cold conditions. Rainfall is also low but not limiting factor for the less production as the evaporation is also low because of the low temperature. The number of species are surprisingly higher as they have evolved remarkable adaptations to survive the cold. They lie near the Arctic Ocean and the polar icecaps. Wherever there is enough combined aquatic and terrestrial net production to support thousands of breeding migratory birds and insects during the summer it also supports the permanent resident mammals. The mammals are musk ox, reindeer, polar bears, and marine mammals. Generally, the large land herbivores are migratory as there is not enough production.

### 5.5.8 Grasslands

This is a type of terrestrial ecosystem. The major grasslands include the Prairies of Canada and the USA, the Pampas of south America, the Steppes of Europe and Asia and the Veldts of Africa. For rainfalls in between the desert and forest i.e. 250 mm to 750 mm the natural grassland occurs. Tropical grassland may have 1500 mm rainfall in a wet season followed by a long dry spell. In the grassland the dominant plant life are the grasses that range from tall species (1.5 m to 2.4 m) to short ones like 20 cm only. Large herbivores are common features of the grassland. The main animal species are wild horses, asses, and antelope of Eurasia: herds of bison of America: and the antelope of Africa. The other animal species are larks, the burrowing owl, jackrabbit, badgers, etc.

The abiotic components of this ecosystem are the essential organic nutrients like C, H, N, O and S present in the soil in different forms. The biotic components are (i) producers like the different grasses such as *Sp. Brachiaria*, *Sp. cynodon*, etc. (ii) consumers like herbivores and insects termites etc. and the secondary consumers like frogs, snakes, lizards, etc. and the tertiary consumers like hawks etc. (iii) decomposers like fungi, bacteria and actinomycetes.

The role of fire is typical in the grasslands. Man misuses the grassland by overgrazing and over ploughing and thus has converted them into deserts. Here is the concern of the environment engineer in the study of all these ecosystems that what we are doing and for what.

### 5.5.9 Forest

The forests are complete ecosystems as are the seas. A well ordered and often lengthy ecological succession is the characteristic with herbaceous plants often preceding trees. So there is a mixture of vegetation including non forest stages in succession as well as forest variants adapted to special soil and moisture conditions. As moisture is more critical to the trees than to the grass, forests occupy a fairly wide gradient from dry to extremely wet situations. There is high species diversity in the tropical rainforest. There are three major types of forests in a north-south gradient. The northernmost forests are characterized by evergreen conifers like Spruce and Fir. The deciduous forests are there in the more southern moist temperate regions. Pines are found in both the forests. The third type is the tropical forest. It ranges from broad leaved evergreen rainforests with good rainfall to tropical deciduous forests that lose their leaves during dry season. The vine (lianas) and the epiphyte (air plants) are special characteristics of tropical forests. Some of the major type of forests are as follows:

- (i) **Taiga forests:** The taiga or boreal forests include the northern coniferous forests the cold climates with high altitude at high latitudes. They extend at an east-west band across north America, Europe and Asia, just the 60° north latitude. The rainfall is 100 mm to 350 mm and the average temperature varies from 6° C to 20° C throughout the year. Taiga forests have dense vegetation and very close trees like pines, spruces, firs, larches, cedars etc. that obstruct the sunlight. The main animals of this biome are large mammals like deer, wolves, bear etc. and small rodents like rabbits and some migratory birds and carnivores land birds like owls and eagles. Though there are many disturbances like fire, storms etc., these forests are rich in lakes, animals, trees etc.
- (ii) **Temperate forests:** They are found in slightly warmer climates. They occur in the regions of north-central Europe, eastern Asia and eastern United States. The annual rainfall is between 750 mm to 1500 mm. The main vegetation is tall deciduous trees like maples, hickories, oaks, beeches, chestnuts etc. These forests are important as the wood produced in them is hardwood suitable as timber for civil works. The animals found are dears, bears, squirrels, snakes, rabbits etc. with plenty of birds and insects.
- (iii) **Tropical rainforest:** This ecosystem is located in the equatorial regions where the average annual temperature is more than 18° C and annual rainfall exceeds 1400 mm. They occur in south and central America, north eastern Australia, Congo river basin of Africa, Philippines, Hawaii and some parts of Malaysia. They cover about 8% of the earth's surface and more than 50%

of earth's flora and fauna. Biodiversity is high. As the climate is warm and humid broad leaved evergreen plants are there. The main animals are monkeys, tropical birds, bats, and so many carnivore animals.

- (iv) **Temperate shrub forest:** These Mediterranean shrub forest are with drier climates and lower (winter) rainfall followed by drought for rest of the year. The most important biome of this category is chaparral. It is a miniature woodland dominated by dense stands of shrubs that seldom exceed a few meter of height. Chaparrals occur along the Mediterranean coast of California, Chile, South Africa and South Australia. They are known by broad-leaved evergreen vegetation. The vegetation is very much fire prone. Reptiles and small mammals are generally found there.
- (v) **Tropical savannah:** These tropical seasonal forests occur where rainfall is high (1000 mm to 1500 mm) but seasonal. They are warm climate plains with coarse grass and scattered trees. They are located in South and Central America, Africa, Australia, south-east Asia and India. There is not much diversity. This ecosystem has giraffe, elephants, antelopes and kangaroos (Australia).

Man has changed most of the temperate forests and grasslands from their primeval condition though he could not change the basic nature of these ecosystems. Actually, we want to combine the grasslands and the forest to make our habitat. We cut the forest to make the land cultivable to get more and more production and we grow trees by the sides of our residences, offices etc. as we know the importance of trees (discussed on page 126. Still it is a matter of research that which option is better. It is true that only the forest cannot cater our needs without agriculture because of this much population. It is also true that we cannot live without trees as they are very much useful to us.

## 5.6 BIODIVERSITY

It is the species diversity. If one species is removed from an ecosystem other that is dependent on it will also go off. In an ecosystem nature has provided so many varieties of plants, animals and micro-organisms, that live in harmony and dependence to each other. If some of them are extinct the whole system gets disturbed. The system tries to adjust itself and succeeds many times but, may fail also. For example the vulture play an important role of scavengers. Due to the problem caused by them in aviation they have been harmed, destroyed and the accumulation of pesticides etc. in their food chain has nearly extinct them. Now the natural removal of dead animals in a short time is harshly affected. The environmentalists are worried about this and we are trying our best to save them.

One experiment was done in which a marine tidal habitat was there having 15 species. One out of them was removed and within 2 years it became 8 species ecosystem.

Actually, in nature, prey-predator relationship should be maintained. Nature has planned everything in a systematic and cyclic manner. As shown earlier there is a chain

and every animal is food for the other. Once, in U. S. A. wolf hunting became a fashion. Thousands of wolf were killed in want of their skin, tail etc. This increased the population of deer and goats. As they moved around, the soil near the rivers was eroded and filled in the rivers and its flood level increased very much. If we extinct the tiger the same thing happens. Means a diverse community is required to sustain. If there are 5 earning members in a joint family and all of them are say doctors. There is one more family in which one is doctor, one is engineer, one is a lawyer, one is a businessmen and one is in police department. If the first family needs some medical help it is well and good. But in case of any other emergency or help it is useless because everybody is a doctor only. Whereas the second family shall stand even in case of any type of emergency and even otherwise shall make more progress. So a diversified community is more strong and sustainable.

### 5.6.1 Basic Laws of Biodiversity

- (i) **Greater is the stability of resources greater is the diversity:** The ecosystem having all required components for the production, sustaining and progress of the species has more potential of supporting so many varieties (diversity).
- (ii) **Diversity increases as a function of climax:** Whenever there is a climax, some other species come forward to face that climax and remains there even after the elapse of that problem, thus increases the diversity. For example if there is fixed temperature, dissolved oxygen and other conditions in a fishery, only one set of fish shall flourish. If the conditions are changed most of them will die except a few that can resist the changed conditions. These second type shall flourish until the conditions are normalized and at the original favourable conditions again the first type shall flourish (with the remaining of second type). So the climax increases the diversity.
- (iii) **The biomass production is proportional to the diversity:** The production of biomass depends upon the availability of resources like food water and shelter (mate). Sometimes because of changed conditions or some disease the production may come down at a very low level. In Silent Valley (Kerala) the normal yield is 10 kg/hectare /year. In controlled conditions it increases to 1500 kg/hectare/year. So it is very active biomass production. With the controlled temperature up to 0.5°C and with virus and bacteria free water, with assisted breeding the production of Kings Crump fish is up to 20000 kg/hectare/year. But if there is any problem of microbes, temperature or salinity the growth reduces to < 1500 kg/hectare/year or even zero. If there is diversity, means many varieties out of which some is sustainable in those adverse conditions then that will come forward and grow to compensate the loss. Once in Indonesia the whole rice crop was lost due to some disease. A rice quality in 'Silent Valley' (Kerala) was found which could survive in Indonesia against that microbe.



- (iv) **Greater is the diversity greater is the stability:** A system having a large number of species is more stable. Think of a world without scavengers. In maintaining the ecosystem with respect to temperature, moisture, salt balance (nutrients) diversity is necessary. As explained above only the diversified community can survive against the adverse conditions, so they are stable.
- (v) **Diversified communities exploit less diversified ones:** In an ecosystem, evolution i.e. natural change continues. Mutation, i.e. cross breeding, natural or forced is also there. The community that is not able to adapt is automatically ruled out. In evolution survival of the fittest in species takes place. 'Packing Order' i.e. ruling order is high; it is fought out by a male. His rule runs, he gets the best of things till a challenger comes and he is dethroned. Lions are individualists whereas elephants live in groups. For both, fights are there for territorial rights or mate. Less strong does not reproduce. Only who can stand the challenge can survive. This is the basic theory of evolution. So a community that is strong because of its diversity rules over the other which is not diversified.

## 5.7 POPULATION ANALYSIS

The number of persons living in an isolated community is known as population. There are dynamic situations changing the population. Growth of the species takes place depending upon the facility. Human beings make the nature to favour them, i.e. to facilitate them and in this process they exploit the nature at a very high cost. To realize this let us understand the various factors of population characteristics, population regulations and population dynamics.

### 5.7.1 Population Characteristics

To assess the population characteristics the following resource constraints or factors are considered.

- (1) Input
  - (a) Individuals coming say by birth
  - (b) Immigration
- (2) Output
  - (a) Death
  - (b) Emigration

The factors involved in the evaluation of birth rate are dependent on:

- Male – female ratio. In Rajasthan say it is 1000 : 830 and in Kerala it is 1000: 1080. The Indian data was 1000 : 932 in 2002 but has further deteriorated in 2006.
- The life expectancy in India is say 62 years for male and 66 years for female, whereas in Japan the life expectancy for female is more than 84 years.

- The 40% of Indian population in 1991 was of 15 years. This has led to the population explosion.

This is true not only for human beings. For every type of species or community habitat is the main factor. The other factors are chance of meeting a mate and the living pattern (group or individual). However, the nature has provided a self regulatory system in animals. For example the ovulation rate of cows decrease in the drought year. Means to cope up the deficiency in the production of grass the cows produce lesser calves. The lions and tigers reproduction rate is reduced if their territory is reduced due to human intervention in the forests.

### 5.7.2 Regulation of Population

In an ecosystem chances of getting mate (individual or group living) decide the population growth. Number of productive females also matter. Prey and predator relationship is also there. As stated earlier auto-regulation is there. Sometimes the species spread out to avoid competition. Sometimes in a longer period of time some characteristics of animals change as that of Giraffe. The following are some of the ways of population regulation:

- (i) Succession:** It is the order of development of species or community. In this, one species become dominant over all others in the community, by elimination. Coconut is predominant in tropical area. In Rajasthan cactus is predominant and so on. By elimination one dominant species remain. If it improves the environment it will flourish. If it worsens it will die out.
- (ii) Climax:** It is the state of equilibrium reached by a plant community. Climax community is a mature community. Initially there is a large number of species. Then some dominant species remain and then by elimination only the climax community remains. By any calamity like landslide, Bhopal gas episode, etc. the community can die out. After some time, again some other will come out.

### 5.7.3 Population Dynamics

As the birth rates, death rates and growth rates can be expressed by precise differential equations, we can develop mathematical models for assessing the population dynamics. Actually, for most of the time in human history the population growth rate was about 0.1% per year, so the population was getting doubled in say 700 years. In the last century it increased to about 2% with a doubling period of about 35 years. This is an alarming state and as such to predict its effect on the environment we shall see some of the mathematical models like Malthusian Model.

#### *Malthusian Model*

If  $N_0$  is the number of any species at a given time and  $N$  is after time  $t$

$dN/dt$  is proportional to  $N$  i.e. the rate of change is proportional to the population at any time.



$$dN/dt \propto N$$

$$dN/dt = r N$$

where  $r$  is the rate of increase.

$$dN/N = r dt$$

Integrating both sides

$$\log_e N = rt + C$$

$$\text{at } t = 0, C = \log_e N_0$$

$$\log_e N = rt + \log_e N_0$$

$$\log_e N - \log_e N_0 = rt$$

or

$$N/N_0 = e^{rt}$$

or

$$N = N_0 e^{rt}$$

So the growth rate is exponential.

For example if population of India in 1991 was say 83 crores. It can be predicted with different rates of annual growth as follows:

$$\begin{aligned} N_{2011} &= 83 \times e^{(25/1000 \times t)} && \text{if } r = 25 \text{ per } 1000 \\ &= 136.84 \text{ crores} \end{aligned}$$

$$\begin{aligned} N_{2011} &= 83 \times e^{(19/1000 \times t)} && \text{if } r = 19 \text{ per } 1000 \\ &= 121.36 \text{ crores} \end{aligned}$$

$$\begin{aligned} N_{2011} &= 83 \times e^{(15/1000 \times t)} && \text{if } r = 15 \text{ per } 1000 \\ &= 96.43 \text{ crores} \end{aligned}$$

This shows the effect of the rate of population growth.

Malthusian Logical Modelling

Malthusian gave logical modeling of population increase. The following curve shows the increase of population if there is no limitation of resources.

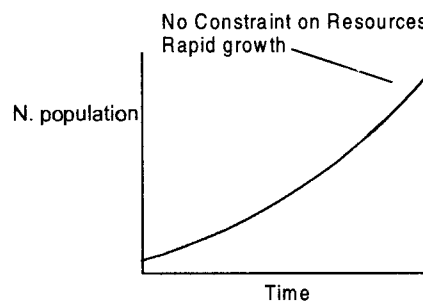

**Population Growth Curve**

An experiment was done to evaluate the growth of grain beetles. The initial number was 100 and the rate of increase was 0.75 per week. Say their life span is 82 weeks

At the end of three weeks

$$\begin{aligned} N(3) &= 100 e^{0.75 \times 3} \\ &= 949 \end{aligned}$$

At other times

$$\begin{aligned} N(10) &= 180804 \\ N(20) &= 3,26,91,737 \\ N(52) &= 8.7 \times 10^8 \\ N(82) &= 5.1 \times 10^{28} \end{aligned}$$

If each beetle weighs 10 grams at the end of 82 weeks the weight of the Beetles would be  $5.1 \times 10^{23}$  M.T., that is equal to the weight of earth. It never happens as the rate of growth can be maintained only with the unlimited supply of resources and no constraint. So the curve is only partially correct. The actual curve shall be as follows that shows that after some time there shall be a fall in the population as the resources are depleted and there is a competition for them. In this competition they kill each other and the population goes down. Then depending upon further availability of resources (food, shelter and mate) their population again increases and so on.

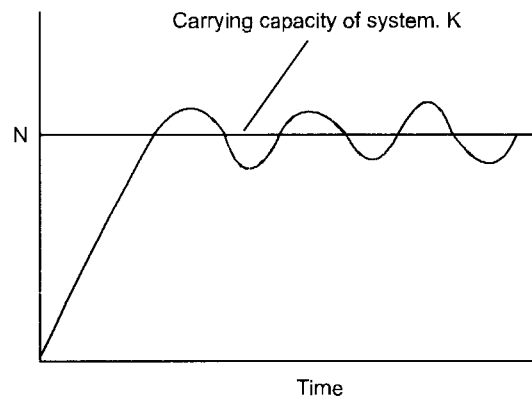

This way the impact of population comes on itself. It goes on fluctuating around a mean value known as sustainable value. This sustainable value of  $N$  is known as the carrying capacity of system designated as  $K$ .

When  $N < K$  there is a positive value of  $r$  (growth rate)

When  $N > K$ ,  $r$  is going to be negative

As we have already seen when there is limitation of resources  $r_m = \text{constant } (r)$  and

$$\begin{aligned}
 dN/dt &= r N \\
 &= f(N) \cdot N \\
 dN/dt &= r_m (K-N)/K \times N \quad (\text{with constraint}) \\
 dN/N &= r_m (K-N)/K dt
 \end{aligned}$$

Which after integration gives

$$N_t = K/(1 + Ce^{-r_m t})$$

$N_t$  = Population after time  $t$

Where

$$C = (K - N_0)/N_0$$

Where

$N_0$  = Initial population

Like this the population growth is limited by itself. However, the human population is increasing in such a way, as if there is no limitation of resources. This is on the cost of environmental pollution and the overexploitation of resources. We know it by ages that the earth is a planet with a self evolving and self regulating system. Whenever there is an enormous load on earth's life supporting system some self regulating event (like *pralaya*) shall come to dismantle everything and a new creation will start. Let us try to maintain the ecological balance by living in harmony with nature and enjoying its fruits without exploiting it.

## 5.8 CONCLUSION

Nature has given us a very good planet for living but we are working against nature. Initially human beings were in a same position as a creature as the others. Then slowly by using their brain they mastered upon the others and the nature itself. This process kept on going on and reached to a level where the human beings consider the whole planet for their comfortable living only. The quest of this so called comfort level has increased to such a level that we are deteriorating, obstructing or completely destroying the natural cycles. The nature works in a cyclic manner and every organism has a role to play. We are breaking such links knowingly or unknowingly. Sometimes the nature adjusts itself and by its alternative routes it keeps on working. Now the time has come that the pollution, overexploitation and the evolution of hazardous things (nuclear weapons etc.) has reached to such an extent that the nature has revolted. It shows all its agony by global warming, tsunami, earthquakes etc. and forced us to rethink. Here lies our concern and study of 'ecology'.

It is in our own benefit to know the different cycles so that we can avoid hindrance to them. The importance of biodiversity is known to everybody. How can it be maintained and why one should work for maintaining it? What are the natural systems of development in earth (ecosystems)? So all this study of ecology is to conserve and protect our planet earth so that the forthcoming generations are not deprived of its blessings.

---

**REVIEW QUESTIONS**

1. Describe the term ecology.
2. What is the ecological classification of environment?
3. What are the objectives of ecological studies?
4. Define the terms; species, community, niche, habitat and population.
5. What is an ecosystem?
6. What do you mean by organism, succession and biome?
7. How do you classify the various aspects of ecology?
8. What is the classification of ecology on the basis of habitat?
9. What are the modern sub-divisions of ecology?
10. What are the functional concepts of ecology?
11. Explain the basics of species.
12. Describe the term ecosystem in detail with its components.
13. Describe the cyclic operations of ecosystem.
14. Describe the geological cycle.
15. Describe the hydrological cycle.
16. Describe the importance of trees in detail.
17. Describe the term nutrients and micronutrients.
18. Describe the carbon cycle with sketch.
19. Describe the nitrogen cycle with sketch.
20. Describe the sulphur cycle with sketch.
21. Describe the phosphorus cycle with sketch.
22. What is the inter-relation of ecosystems and human beings?
23. Describe the various biomes and ecosystems.
24. Discuss the energy flow in ecosystem.
25. Describe the role of solar energy in ecology.
26. Describe the sea as an ecosystem.
27. Describe the estuary as an ecosystem.
28. Describe the stream and river as an ecosystem.
29. Describe the lakes & ponds as an ecosystem.
30. Describe the terrestrial formation as an ecosystem.
31. Describe the desert as an ecosystem.
32. Describe the Tundras as ecosystem.
33. Describe the grasslands as ecosystem.

34. Describe the forest as an ecosystem.
35. What is biodiversity?
36. What are the basic laws of biodiversity?
37. Describe the population characteristics analysis in ecology.
38. How the population is regulated?
39. Describe the population dynamics.
40. What is Malthusian logical modeling?

# **RENEWABLE SOURCES OF ENERGY**

---

---

## **6.1 INTRODUCTION**

Society in general has become aware about the conservation of resources and protection of environment. Though the awareness has come after a great loss to the environment in the form of global warming, acid rain and ozone depletion etc. The environmental degradation cannot be dealt within isolation. It has close relation with energy obviously the clean energy, green energy. The energy resources that we are using conventionally like coal and other fossil fuels, have come to the present state in millions of years. We have used them for thousands of years and they are going to be depleted in hundreds of years. So they are non-renewable, we call them renewable if they can be replenished within the average lifecycle of human being. Renewable energy is the energy that will never end (Akshaya urja shrota). It can be conveniently used to produce electricity and heat we need in our homes, schools, offices, factories etc. In India and all over the world, more and more people are using renewable energy, as it is a very good way of safeguarding our environment. They are less harmful than other kinds of energy sources such as coal, oil and gas (fossil fuels). Fossil fuels are limited in nature and they produce harmful greenhouse gases resulting in global warming. They also produce oxides of nitrogen and sulfur that cause acid rain and various diseases.

Actually, the environment i.e. the living conditions in which we live, play a very important role in the efficient working. But in place of comfortable living the time has come that the very existence of life on our planet is endangered because of the environmental pollution. Exponentially increasing population, rapid growth of industrialization and the global trend of urbanization have totally disturbed the Eco-balance. This type of development cannot be sustained for a long time and the policy

planners have to seriously think over it. The discussion in this paper is intended to consider the scope of using renewable energy resources to meet the ever-increasing demand of electricity.

Energy in the form of electricity is critical for economic growth, social development and human welfare. In this materialistic world the status of a country is adjudged by its per capita consumption of electricity. That way our per capita consumption of 350 kWh per annum may be ten times less in comparison to the United States and proves us to be a poor and undeveloped country. This may not be true as the living habits of our major countrymen i.e. the rural masses are totally different. They live closure to nature and by their age-old practices they utilize the energy gifted by nature in a more natural way. This was true when India lived in villages but now the pattern is changing. 11% of our population living in cities in the year 1901 has become 26% in 1991. This urbanization has changed our living style and we are also in the race of consuming more and more energy even at the cost of environmental degradation. India with its present installed capacity of 1,30,000 MW is facing a 10% deficit per year, which results in a loss of production of about 2% of the national income. All of us are aware of the power cuts for most of the times in a year.

But the question is this that where this present system of energy conversion and utilization will lead us? At present the electricity production in India is roughly 68% by coal and other fossil fuels, 22% by hydropower, 4% by nuclear and only 6% by renewable energy sources, though there is a large scope for it. The present installation cost of electric plant based on fossil fuel is about Rs. 5 crore per MW and that by solar photovoltaic may be Rs. 200 per watt i.e. 20 crores per MW. But this type of comparison is unfortunate. All of us know that the fossil fuels are not everlasting. They are depleting at a very fast rate, and the main thing is the pollution caused by them. The pollution in terms of suspended particulate matter (S.P.M.) in the air of Kota was found to be on average 1000 microgram per cubic meter. Water which is the second biggest need of survival has become so much polluted that the government has to spend 10 times of the money on its purification than the revenue realization. Still a large portion of our rural masses is deprived of electricity and safe drinking water and the urban population is facing the pollution problem.

Is this the sustainable development? Can it be sustained for all times to come? It is neither sustainable nor holistic development. Sustainable development is a term that emerged from the 1992 Earth Summit in Rio de Janeiro. Sustainable Development enjoins upon the world community to manage development in such a way that generations are not deprived of the benefits of the planet's resources particularly its life supporting systems, land, forests, air, water and the oceans. The concept is "to meet the needs of the present without compromising the ability of future generations to meet their needs".

Sustainable development can only be achieved if a close link between environment and over-arching agenda for poverty eradication and development is achieved at the

earliest. In this context one may be Eco-centric or techno-centric. A middle path, obviously, is desired state as development at the cost of environment can only be at the peril of mankind and such development cannot be sustained .

## **6.2 RENEWABLE SOURCES OF ENERGY**

The renewable sources of energy dealt here are solar energy, wind energy, energy from water, energy from the oceans, energy from biomass and the geothermal energy.

### **6.2.1 Solar Energy**

Sun is the prime source of energy. Sun daily spreads an enormous amount of energy; out of which our mother earth receives a very small fraction. Even that small fraction is so much that is sufficient to meet all our demands. The energy that is directly received through the solar radiation can be classified as solar photovoltaic and solar thermal. The word PV means “voltage from light”. The photovoltaic cells are used to turn sunlight directly into electricity. PV cells generate power through the interaction of tiny particles of light called “photons” with electrons in the cells. PV cells were originally developed for use in space program, PV cells have powered nearly every man made satellite sent into the orbit. These days many equipment are using solar energy in this way and so many buildings are being equipped with arrays of PV cells for meeting their electricity demand. In this way of solar energy conversion by photovoltaic means the semiconductor silicon cells directly convert the sun’s light into electricity. But the efficiency is very low and the cost is high because of the problem of very high requirements of purity of material. The material should be almost cent per cent pure. For small applications the cost may be as high as Rs. 3 lakh per kW. One solar photovoltaic pump of 1 H.P. costing Rs. 2.5 lakh is successfully running at Engineering College Kota under the Renewable Energy Park Project funded by M.N.E.S, installed by R.E.D.A. with author as the principal investigator. Though costly but the PV method of solar energy conversion is very much suitable for decentralized small uses like remote village electrification etc. The PV cells are modular in nature, having long effective life, with no moving parts and no pollution. But the problem of storage in lead acid batteries is typical. However, on the basis of domestic R & D India has become the second largest manufacturer in the world of solar photovoltaic panel based on crystalline silicon solar cells. Advanced countries are working to install thin PV sheets having very large area in the geo-synchronous orbit of the earth so that they can continuously generate electricity and send it to the earth in the form of microwaves.

The other way of harnessing the solar energy is by solar thermal means. In this method sunray’s heat energy is used either for air, water heating or for the production of electricity. In the later case some parabolic dish concentrates the rays or other deflectors to some fluid like oil and this stored heat is converted to electricity by turbines. At the solar energy center at Gualpahari near Gurgaon electricity is being produced by this method. The Rajasthan State Power Corporation Limited is going to install a 140 MW integrated combined cycle project having 35 MW solar component, at Mathania in



Jodhpur district. It will be a solar chimney based power plant where heated fluid will be air. In this method the sunrays are passed through some glass cover, which has the property of allowing sun's short wave radiation and entrapping the heat of long wave radiation. Thus the temperature inside a collector can be increased to a very high level that can be used for heating air or water for conversion into electricity or solar cooking, solar drying, solar water heating or space heating for comfort in buildings.

A large portion of energy is used in the building industry, in manufacturing the building materials and in space cooling and heating. Domestic and building sector accounts for an average of 45% of the developing countries total energy consumption. Just as in Europe, America and the rest of world where temperature remain below freezing point in winter, scientific and technological advancements have made things easier for people of Ladakh. Solar buildings are now being constructed in the region to fight chill. Ladakh is cold and semi arid, where temperatures vary between  $-30^{\circ}\text{C}$  and  $-60^{\circ}\text{C}$  in winter. Ladakh Environment and Health Organization (LEHO) have introduced solar buildings in Ladakh. The passive solar heated building admits solar radiation through glass and stores it in a dense material-thermal mass, which can then release the heat slowly. The temperature inside the building remains 15 to  $25^{\circ}\text{C}$  depending upon the glazing, insulation and availability of radiation. This reduces the heating requirement of the building and thus saves electricity.

The following photographs show the photovoltaic cell modules and solar water heaters

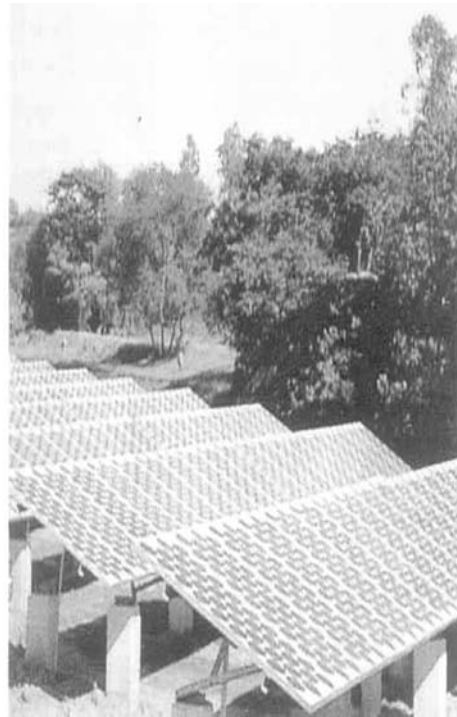

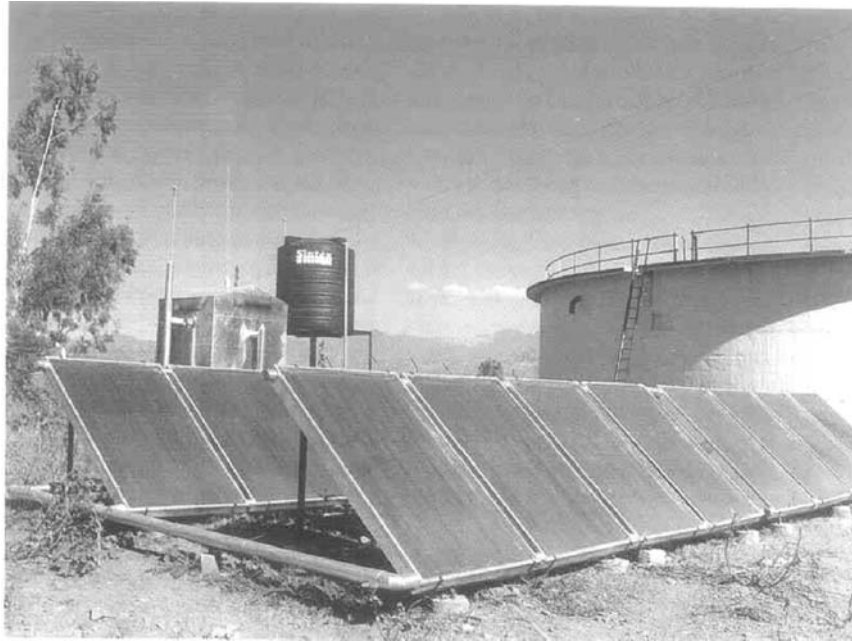

### 6.2.2 Wind Energy

Since long time windmills are used to mill wheat and pump water. Modern windmills are called wind turbines. They transform the energy in the wind into mechanical power, which can then be used to produce electricity. Wind turbines can be used singly or in clusters called wind farms and are usually about 60 m high. Small wind turbines called wind chargers are used to charge batteries and can be used by unelectrified homes, boats etc., to power television and other domestic appliances and so on. For the economical harnessing of wind power a wind velocity of about 7 m/sec. is required which is the major limitation of this system. However, the conversion of wind energy into electricity has increased to 6315 (1/1/07) MW which is more than half of the total production by renewables. It is under sincere considerations even in Rajasthan. 2 MW wind project started in Jaisalmer on 14<sup>th</sup> August 1999. Rajasthan State Power Corporation Ltd. Plans to construct a new 1-billion rupee 25 MW Wind farm in the district of Jaisalmer. The development is one of the 28 planned state government wind projects expected to generate a total of 444.25 MW of electricity. As per the officials the state government is also considering other sites at Devgarh, Harhnath, Jaisalmer, kohdal, Mohangarh and Phalodi for the potential establishment of wind farms by private developments.

The following photograph shows the wind farm (a collection of aerogenerators for the production of electricity).



**6.2.3 Energy from Water**

Hydropower generation is a conventional renewable energy resource utilization method that is most environmental friendly but the problem of rehabilitation is typical. The uncertainty of rainfall and regional problems of water use and distribution are never ending. The ambitious river inter-linking project is yet to be tested. Mini and micro power plants can help in solving the problem. Small hydro Power (up to 25 MW), included in the category of renewables has a large share in the total achievement. The following photograph shows a dam for a hydroelectricity power plant.



### 6.2.4 Energy from Oceans

Ocean is also a source of renewable energy. It can be harnessed in three ways. First is the ocean thermal energy conversion method. The temperature difference of about 25° C between the upper layer of water and a layer 1000 m below can be used in a heat engine to produce electric power. Tides can be used as a source of energy from the oceans. Large structures like barrages can be built which allow tidal water to pass through large turbines for producing power. The third way of harnessing energy is the use of sea waves. In India it is generally felt that only tidal energy can be harnessed in the foreseeable future.

### 6.2.5 Energy from Biomass

Trees and other vegetation convert the sun's energy directly into the useful biomass. The biomass can be converted into biogas or bio-liquid ( bio- diesel) and used as a source of energy. Using the wood and other agriculture waste directly by burning is the most inefficient way of energy conversion. By converting it into biogas at least 25% more energy can be obtained alongwith the benefit of useful natural organic manure. Biomass is derived from the carbonaceous waste of various natural and human activities. Is obtained from numerous sources including the household waste. Biomass does not add CO<sub>2</sub> to the atmosphere because it absorbs the same amount of carbon in growing as it releases when consumed as a fuel. Unlike other renewable energy systems that require costly advanced technology, biomass can generate electricity with the same equipment/ power plant that are burning fossil fuels at present. In the biological conversion method biomass is converted into biogas by anaerobic decomposition method. The raw material may be cattle dung or the organic part of the municipal solid waste.

Sometimes the use of other biomass like Water Hyacinth (*Jal Kumbhi*) helps in the reduction of flow hazards produced by it in the water bodies. In a study made in the engineering college Kota in which water hyacinth was taken from the local reservoirs and used as the biomass for biogas production, it was observed that it could be used efficiently to produce biogas. So in the communities where cattle dung is scarce and water hyacinth is available in plenty it serve both purposes of water hyacinth eradication and biogas production.

Even human excreta can produce biogas. Aryan society for environmental research and Development, Jaipur has installed a night soil based biogas plant at the police lines Udaipur and at the bus stand in Nathdwara. In the thermochemical use of biomass the various crop residue like rice husk can be burnt in boilers or pellets can be made and electricity may be generated in the power plants. These methods not only help directly in the electricity production but also help in reducing the waste management problem.

### 6.2.6 Geothermal Energy

The core of earth is very hot. It is possible to make use of this geothermal energy. In some countries such as the U.S., hot water is pumped from underground water deposits and used to heat the residences.



### 6.3 POTENTIAL OF RENEWABLE ENERGY RESOURCES IN INDIA.

India's so far assessed potential of wind power is 45000 MW, small hydro power 15000 MW, biomass power 21000 MW (including bagasse cogeneration) and energy recovery from waste is 2700 MW (9) i.e. the total is 83700 MW. Out of this the achievement upto 31.12.2006 is 9265.31 MW. The complete status is as shown in the table.

**Table 6.1 Renewable Energy at a Glance in India**

Source 'Renewable Energy', 'Akshaya Urja' Volume 3 issue1 Jan-Feb 2007 Ministry of New and Renewable Energy Government of India.

S. No.	Source/system	Estimated potential	Achievement as on 31 <sup>st</sup> Dec. 2006
I	Power from renewables		
A	Grid interactive renewable power	MW	MW
1	Solar photovoltaic power	-	2.74
2	Wind power	45000	6270.2
3	Small hydro power (up to 25 MW)	15000	1860.79
4	Biomass power	16000	500.0
5	Bagasse cogeneration	5000	595.83
6	Biomass gasifier	-	1.0
7	Energy recovery from waste(MW)	2700	34.95
	Sub total (A)	83700	9265.31
B	Distributed renewable power		MW
8	Biomass/cogeneration (non-bagasse)	-	30.3
9	Biomass gassifier	-	82.65
10	Energy recovery from waste	-	11.03
	Sub total B		123.98
	Total A + B		9389.29
II	Remote village electrification		2237 villages/594 hamlets
III	Decentralized energy systems		
11	Family type biogas plants	120 lakh	38.90 lakh
12	Solar photovoltaic programme	20 MW/sq.Km	
	i Solar street lighting system		54659 nos.
	ii. Home lighting systems		280813 nos.
	iii. Solar lantern		403058 nos.

Contd....

	iv. solar power plants		1859.8 kWp
13	Solar thermal programme		
	i Solar water heating systems	140 million sq metre collector area	1.65 million sq metre collector area
	ii. Solar cookers		6 lakh
14	Wind pumps		1137 nos.
15	Aero generator/hybrid systems		494.68 kW
16	Solar photovoltaic pumps		7015 nos.
IV	Other programmes		
17	Energy Parks		472 nos.
18	Akshya Urja shops		401 nos
19	District Advisory Committees		550 nos

#### 6.4 CONCLUSION

There is an acute necessity of switching over to the renewable energy resources, as they are ever lasting, environment friendly and thus sustainable. The present conventional sources of energy are fastely depleting and are not eco-friendly. While comparing the costs of electricity production by coal, oil etc. with the solar, wind etc, the overall environmental cost and their decentralized nature, which stops the migration of rural masses should be considered. The present higher rate of electricity production is because of the developing stage of renewable energy sources. The increasing R & D, and the utilization of RES on mass scale will certainly bring them at par. Large potential of renewable energy resources is available. Capacity building of individuals and organizations; proportionate investments in renewable energy technologies, production facilities, market infrastructure and human resource development are all required for a rapid growth of the global RE market. The lack of awareness alongwith the lack of both senior and middle level local technical manpower is proving to be the biggest barriers at present. Awareness, education and training unlock human potential and can be powerful force to shape positive social and economical development around the world. In the renewable energy field all modes of education are therefore of prime importance, especially about the use and potential of RE technologies, in all teaching institutes. Additionally industry non-government and voluntary organizations and society at large need to get involved in this initiative to make renewable energy education/ capacity building a people oriented program.

**REVIEW QUESTIONS**

1. What do you mean by renewable sources of energy?
2. What is the necessity of using renewable sources of energy?
3. What is the present installed capacity of electricity generation in India? What is the share of all types of electricity generation methods?
4. Describe the sustainable development.
5. Discuss the uses of solar energy as a source of electricity and heating.
6. What are the solar photovoltaic cell? Describe the advantages and disadvantages of their use.
7. Discuss the uses of wind energy as a source of electricity and heating.
8. Discuss the use of water for generation of electricity.
9. Describe the different ways of harnessing energy from ocean.
10. Describe the extraction of energy from biomass.
11. Describe the geothermal energy.
12. Tabulate the status of renewable energy resources in India.
13. What is the scope and future of renewable energy resources in India?



**This page  
intentionally left  
blank**

# ***ENVIRONMENTAL IMPACT ASSESSMENT***

---

## **7.1 INTRODUCTION**

Environment is defined as the surroundings in which we live. It has the living component known as the biotic and the non-living known as the abiotic environment. In the living part all the plants animals, human beings, micro-organisms such as the bacteria, viruses, fungi etc. are there. In the non-living part the materials, temperature, humidity, air, soil, water, fire, energy, sky, noise, solar and other radiations are there. All of these are in dynamic equilibrium with each other. Every action of the nature is cyclic. We have seen so many cycles like the material and nutrient cycles, hydrological cycle etc. These cycles are interrelated and the occurrence of one depends upon other also. As there is a dynamic interrelationship between the components of the environment, so nothing can be dealt in isolation and one has to think in a holistic manner. Holistic means considering others also alongwith ones development. The oriental practice was to worship the nature. Nature was respected. We felt gratitude to the nature for bestowing its unlimited uniform blessings upon us. The sun shines for each and every one of us with the same intensity. Every natural blessing is impartial and sufficient. It is sufficient for everybody's need but not for anybody's greed. Forgetting this basic fundamental theory, we have started exploiting the nature. Nature has some power to compensate the loss that is some adjustments it can do. But the situation has come where it has gone beyond its power of assimilation and it has started reacting. The global warming, earthquakes, Tsunami, Al-Nino and other calamities are the recent examples. Some of them may be natural phenomena but generally it is the human beings who are responsible for them.

So the time has come that we must wisely check and analyze our activities with respect to the nature or the environment.

For any activity in the nature initially the yield is more and waste is less. There is a dynamic balance in nature that when yield increases waste increases. Waste means undesired product. It may be depth of water table which increases due to exploitation of ground water at faster rates.

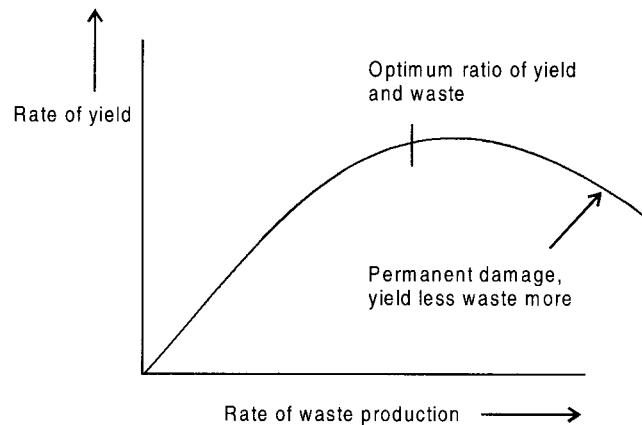

To maintain the quality of environment it is the sustainable development, in which no waste is accumulated in the nature (time lag may be there), but all the waste is absorbed.

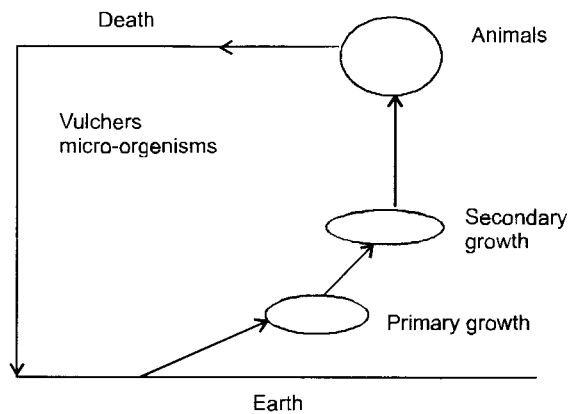

In some conditions the time may be too much, no scavengers are there, the waste will be remaining there and accumulating. Nature has a capacity to maintain cycle, waste is used, but after some rate it collapses. For example if we keep on using fossil fuels, future generations will not use it as it is limited. Where as if we use hydropower we can keep on using it till the sunshines as the water is lifted up and comes back on earth with a new potential energy. So sound development is sustainable one.

When we look around and see what is going to happen in other areas (take care of others) it is the **holistic development**.

## **7.2 NECESSITY OF ENVIRONMENTAL IMPACT ASSESSMENT**

In the holistic and equitable development one takes care of others, means what so ever engineering project we plan or execute we consider its effect on the biotic and abiotic environment in which it is going to be implemented. This is known as environmental impact assessment.

Forest as a complete ecosystem is a good example. It provides shelter. It is a habitat for large number of species. The electricity consumption in India, 350 kWh per capita per year, is very less in comparison to other developed countries as we are mainly dependent on firewood which comes from the forests. Nearly 15000 crores of fuel is burnt in India per year, for cooking which comes from forests. Besides firewood it gives us many other products like gum, resins, thorn, timber, medicinal herbs etc. as discussed earlier. So forest is our life line. Whenever, we have a project we have to asses its impact on this lifeline.

What will be the effect of navigation on water course? It shall be the spread of oil, grease, noise and water currents. One has to consider all these negative impacts.

For a good and exhaustive example let us consider the environmental impact assessment of some big projects like water resources project. First of all in 1970 s Aswan Dam constructed on river Nile had a problem of its impact on environment. The problem may be of seismicity. Earthquakes below 2.5 intensity on Richter's scale goes unnoticed whereas those more than 4 are felt with discomfort. Kariba and Koina are the places where first of all it was assumed that earthquakes took place due to construction of dams. But the actual effect is not quantified yet, though a certain correlation is there.

Changed water balance is, of course, to be studied. When we have irrigation projects the hydrology of the area changes. In the command area per square meter availability of water is much higher than required so water logging takes place. The consumptive use of water is 4 to 5 mm/day for plants. 90% of water taken by a tree is evaporated and only 5% is used by the body. As lesser water is consumed by plants in a command area so high water vapours will be formed that will increase the humidity. The rise in humidity shall have microclimatic changes like change in temperature. Water logging takes place as a result of supplying more water than required. Flood pattern downstream are changed. Drought characteristics are changed. The filling done in construction of canal embankments blocks the natural water ways. In command area type of crop is changed. Wheat is replaced by cotton, sugarcane etc.

Soil is endemic saline if it contains salt. When no water was there to leach salts, it remained at bottom. When the level of water comes up the salt comes up and when it gets evaporated the salt remains there only and the soil becomes saline. So many other impacts are there and as such, before the actual quantification one has to finalize the areas on which the impact assessment is to be done.

### 7.3 METHODOLOGY OF ENVIRONMENTAL IMPACT ASSESSMENT

The following steps are taken in the overall assessment

- (i) Identification
- (ii) Data collection
- (iii) Prediction
- (iv) Assessment

Let us discuss them one by one with some specific examples.

#### 7.2.1 Identification of Impact Areas

Depending upon the project under study there are so many areas over which the impact assessment may be made. Some of them are common and can be usually applied on all projects.

##### 7.2.1.1 Water Resource Project

Let us consider them for a water resource project. It has a dam, reservoir, canal and the distribution system etc. The dams have a large impact on the environment as sometimes they are very large. In Egypt, the Ashwan High Dam is seventeen times heavier than the great pyramid of Cheops. In Ghana the Volta Dam impounds a reservoir of the size of the Lebanon. Construction of dam inundates large areas of the fertile land. It is difficult to assess this loss. It is not only in terms of just the market value of the crops lost but also the top fertile layer of soil known as the humus. Nature takes hundreds of years to make one inch of humus. Vast area of land has been submerged under the water resources projects. For example 84800 hectare were lost in the Volta Dam. 510000 hectare was lost in the Kariba Dam and 400000 hectare submerged by the water of Lake Nasser. The Narmada Valley Development Project in India with 30 big and 3000 total dams will drown 350000 hectare land.

Let us study the impact of the water resource project one by one in different areas.

- (1) **Population:** When a dam is constructed to store water a large reservoir is created on its upstream. This reservoir may be sometimes spread in kilometers. So the land or forest or habitation submerged under this water is lost for ever. A tree may cost some thousands of rupees for an engineer but its environmental value is in lakhs. As explained earlier if the services rendered by a fully grown tree for its whole life are quantified in terms of money it is about 5 lakhs. The environmentalists have warned that in Narmada Sagar command area the cost of submerged forest is Rs. 30000 crores. They have also estimated that by the construction of Narmada Sagar Dam (second largest of the Narmada Valley Project) 30000 families ( 2 lakh persons) shall be displaced. The same has happened for Tehri Dam. The occupants of town Harsood did not vacate the town until it was really submerged. Actually this is the biggest problem. Nobody wants to leave his place. The same

examples are there for other countries also. By the construction of Three Gorges dam in China 1.4 million persons were displaced. Ghana's Volta dam saw the evacuation of some 78000 people. The Pa Mong project in Vietnam uprooted 4,50,000 people. The Narbada valley development project of India (having many small and large dams) shall also displace about 1 million people. As a general estimate for every 100 benefited persons about 6 are at loss (to be rehabilitated). The displaced persons of Pong dam could not be rehabilitated for decades. Ultimately they were shifted to Rajasthan where they faced many problems of harsh climate and different culture. The problems of resettlement are as follows:-

- (a) As compensation to the acquired land the government pays in terms of the last registry rate that is always lesser than the market value.
- (b) Generally those who obey the orders first are at loss as they get the initial compensation and are away from the scene. The more adamant ones sometimes get more compensation.
- (c) The houses, trees, Dharies (hamlets), wells etc. are assessed by the government officers on there set rules of Basic Schedule of Rates that is always less than the actual. In the B.S.R the depreciated value of house in 100 years becomes nil whereas in practice people live in houses that are older than 100 years. So it becomes difficult to decide about the compensation of such old houses. Same is the case of trees. The tree is assessed on the basis of its girth and the assessed cost is something about 3 to 5 thousand depending upon the wood. But the real cost (environmental cost) is very high.
- (d) Land to land conversion is not possible because the government lands of the same type (fertile) are not available. When money is given in compensation to land it is generally not utilized in purchasing the land and spent in some other unuseful expenditure like marriages etc. Many times the sons get it divided and the hard earned asset of the farmer is snatched from him leading him to be bankrupt in some cases.
- (e) The shifting charges are meager say 1500 Rs. Per family. The families in the villages are combined families and when they lose their land and get money, the joint families split up and as such the shifting charges for such increased families become totally insufficient.
- (f) The main problem in resettlement is the sentiments of people. Everything cannot be compensated in terms of money. The feelings attached to the houses, fields cannot be quantified in terms of money. The feeling of uprootment and to settle in new conditions is intolerable especially for elderly persons.
- (g) Sometimes some over wise persons go on such sites and encroach some land to get fake compensation.

Considering all these problems the engineers, planners and managers must take the people in confidence and realize their problem in totality. The policy should be framed to rehabilitate (*Punarvas*) them not to only resettle (*punarsthapan*) them. The difference in the two is the real key to success. In the rehabilitation the new village is constructed as the old was. Considering their local demands of panchayat- ghar, open wells, community places, schools, dispensary, meeting places etc. and the construction should be suiting to their local requirements. Generally government makes same type, stereo type, row houses for them that are never accepted to them. Making a village similar or improved to the old one with people's participation and their will is the real rehabilitation. The policies and awards should be site specific and made on ground realities. Any single policy made indigenously or borrowed from foreign countries cannot be successful in the vivid conditions of our country. For example the problem of land acquisition for the construction of Rjeev Gandhi lift water supply canal for Jodhpur was solved by raising the peoples sentiments for a noble cause of supplying drinking water to human beings and cattle's of the desert district. The feeling of sacrifice for others generally works in such matters.

- (2) **Meteorology:** As a large reservoir is formed or a canal passes through a region local microclimatic changes take place. Presence of water vapour is most important. The maximum temperature comes down and minimum temperature increases. Number of hot days will reduce. Stretch of high temperature will also reduce. Nights will be warmer. As the humidity increases there may be local showers. Permanent presence of clouds will remain. In Aswan dam (Egypt) 5000 square kilometer are of reservoir is there so permanent clouds are formed giving daily some showers.
- (3) **Water resources:** As it is a water resource project obviously the water resource on upstream side shall increase so there is a positive impact on upstream side. The down stream of the river shall face water shortage. But the overall impact is positive as a dam prevents the fresh sweet surface water to be ultimately mixed with the saline water of the sea. So the net balance is positive. The dam also prevents the flow of useful silt to the sea and thus saves a very large amount of money in terms of humus and useful silt.
- (4) **Floods and droughts:** The main purpose of constructing a dam is safety against floods. A dam stores the rainwater at the time of storm causing floods and relieves it throughout the year as per the demand. Particularly in summers when there is no rainwater and the river is also dry, irrigation can be done through the canal system. So the impact is positive on both floods and droughts and if quantification is done, maximum marks in favour of the project shall be given on this basis.

- (5) **Water quality:** In the reservoir the water stands still so due to sedimentation the silt and other settleable impurities settle down. Water becomes clear as the turbidity reduces so it is a positive impact on water quality from aesthetical point of view or drinking water point of view. From irrigation point it is a negative point as the silt is always useful for crops. The second quality parameter is dissolved oxygen. Water takes D.O. from the air and it gets mixed in it depending upon the deficit and the temperature etc. Water has a specific capacity to contain the D.O. at a temperature. For example it can have 9.17 mg/litre of dissolved oxygen at 20° C. It reduces as the temperature increases. Minimum 4 mg/l (ppm) D.O. is required for the existence of aquatic life. When the sewage or the organic matter in any form gets mixed in the river water the bacteria consumes this D.O. for its decomposition. As the D.O. reduces water tries to recuperate it from the atmospheric air. As soon as the upper layer of water gets saturated the further penetration of oxygen reduces. When the river is flowing with turbulence the upper layers come down and the lower layers come up to absorb more and more oxygen and thus the whole water is having good amount of D.O. But when the water is stored in a reservoir this phenomenon stops and only the upper layer is exposed so the D.O. reduces and thus it is a negative impact on the quality of water.

Due to the increased depth in the reservoir the penetration of sunlight reduces and the formation of oxygen by photosynthesis also reduces. This deteriorates the quality of water and thus it is also a negative impact.

In the reservoirs generally the sewage of the nearby cities is discharged which is full of nutrient (nitrogen, phosphorus etc.) Due to increased nutrients heavy growth of plankton takes place. This can be phytoplankton or zooplankton (wandering). Blue green algae can grow even in the absence of nutrients as it takes nitrogen from the atmosphere. The velocity of water is zero and nutrients are there so the aquatic plants like water hyacinth flourish like anything. These plants cover the whole lake or the reservoir in very less time. This further reduces the penetration of sunrays and thus causes anaerobic conditions. This is known as eutrophication and is a negative impact on water quality.

- (6) **Water logging and salinity:** Generally, the reservoirs are not situated on completely impervious base. The canals also have seepage inspite of all efforts. This water goes down and if the soil is impervious it comes back on the surface and stands still there only. This permanent storage of water in the root zone of plants is known as water logging. This does not allow the growth of any plant as air is a must in the root zone of the plants. So this is a negative impact. In the initial reaches of Indira Gandhi Main Canal (near Hanumangarh) and also near R.D 1120. water logging has taken place. This has reduced the cost of previously costly land to almost zero. The seepage water dissolves the salts



of the soil and they come up with the water. The water evaporates leaving the salts there only which makes the soil saline. The saline soil is unfit for irrigation and thus this is a negative impact.

- (7) **Water supply and sanitation:** The water resource project certainly increases the water supply on the upstream side. This water is used mainly for irrigation and also for drinking water supply. Though the quantity of water used for drinking water supply is very less in comparison to the irrigation water sometimes it may be more important for example in desert areas. In any case the water supply increases and people feel comfortable. At least animal husbandry (cattle business) can support human life in such desert areas with less scope of agriculture. The increased water supply increases the sanitation also. When there is enough water for cleaning, bathing and removing the fecal matter with water (water carriage system) then good sanitation can be maintained. So it is a positive impact. However, the water carriage system (flush system) requires a very large amount of water 99% to carry very small amount of night soil (fecal matter) (1%) and as such a wastage of good quality potable water. Any way the diseases due to poor sanitation are reduced.
- (8) **Drainage:** As the water supply to the towns increases the waste water (sewage) comes on the streets. With less water and less sewage it could be managed in kitchen gardens and the open drains. As the volume of water increases many times and the sewage conveyance and treatment becomes necessary before its disposal. The sewerage system is very costly, even costlier than the water supply system. In India we still do not have sewerage system in most of the cities.
- (9) **Soil:** The soil is affected mainly by two ways
- Fertility:** With the plenty of irrigation water farmers take two to three crops in a year. Due to over utilization of land the fertility of soil reduces. Though we add fertilizers, artificial or organic, but micro-nutrients are not there. So the overall fertility reduces and the biology of soil changes.
- Soil erosion:** Increased farming operations, like tilling, loosens the soil which in turn gets easily eroded by flowing water or the wind storms. The top soil known as humus is washed away in few years where as it has taken thousand of years in the production. Roads are made and the excess cutting may lead to slope failure. Increased pore water pressure leads to land slides. The right bank of river on which Vaiont dam was there in Italy ( a double arch dam) collapsed and fell in the river in 1962.
- (10) **Land use:** The land use pattern changes drastically. The plenty of irrigation water increases farming and cultivation. The grasslands and land for grazing of cattle also comes under cultivation (agriculture). The animals find it difficult

to live and their encroachment to the fields give rise to fights and legal cases. Industries related to agriculture and others come up. Roads, godowns, construction camps, housing projects are developed leading to urbanization.

- (11) **Agrochemicals:** For the increased agriculture more and more agrochemicals like fertilizers (Urea. D.A.P.), pesticides, insecticides, etc. are used. Generally they are used even more than the required quantity. D.D.T. is banned in the advanced countries but still used in our country. These chemicals enter into our food chain and many times their concentration in mother's milk is much more than permissible. Recently it was found that the concentration of pesticides in the cold drinks was much more than permissible. Sometimes the farmers are so wise that they don't use chemical fertilizers and pesticides on the product they use for their own consumption. Even such products are available in market that have been grown on natural organic manure or vermicompost (made by special earthworms, naturally) and without the use of pesticides, but at a higher rate.
- (12) **Ecology:** As the water resource increases more and more land comes under irrigation and the farmers grow only those crops that pay them the best. So the species diversity gets reduced. Production is more under favourable conditions so wild and tough goes away. All the ill effects of reduction in biodiversity are there.
- (13) **Forest:** The area of forest gets reduced due to submergence. About 2% of the forest area has been reduced due to submergence of water resources projects. The type of forest changes from close forest (> 40% is covered by self generating set of plants), to open forest (10-40% covered by plants) or to scrubland (< 10% ). Tribes live in harmony with forest and wild life but when they are displaced they cause deforestation.
- (14) **Wildlife:** Forest is the habitat for wildlife. Presence of human beings make disturbance even if the forest is not cut down. As the canals, roads etc. are constructed the animals feel segmentation of their habitat. The interference, quality change (running water becomes stagnant) and segmentation leads to direct reduction in their reproduction rate. Particularly for the lion group the reproduction gets substantially reduced in lieu of the reduction in area under their command. The aquatic life is also affected. Estuarine fish moves for salinity from land to sea for breeding. If there is some obstruction (dam) their movement is stopped and thus reduces their breeding. Even if we provide fish ladders only 15% can use it.
- (15) **Fisheries:** The species diversity of the fisheries is reduced because of the development of man made controlled fisheries. Fish are very sensitive to dissolved oxygen, temperature and salinity. They have some breeding habits

and their herding (shelter requirement ) is peculiar. For example the estuarine fish requires salinity. The assured water increases the habitat and their production though species may be limited. Tilapia, catla catla and corps are generally grown. The production may be as high as 20000 kg/hectare/year under controlled conditions, but may come to about zero if the conditions are unfavourable as species diversity is not there.

- (16) **Seismicity:** It is said qualitatively that the construction of dams increases the chances of earthquakes (seismicity), though quantitatively it could not be assessed. Actually it is the fear due to the accumulation of huge quantity of water in the reservoir that can induce earthquake. But if we compare it with the large quantity of total water on the earth, it proves to be futile. Two third of the earth is covered by water and the fresh water flowing in the rivers is a very small fraction of the total water. If we restrict (store) a small portion of this little water, it is negligible in comparison to the sea water. So it can not disturb the balance, causing the earth quake. However the seepage water from the reservoir may disturb the tectonic movement of the plates if it reaches to that level. So the dam should be constructed at a safer place and the design should include the possible earthquake forces.
- (17) **Air quality:** Fortunately in water resources project followed by the hydroelectricity generation plant there is no emission of gases or the particulate matter. Only some dust problem may be there at the time of construction particularly if the dam is an earthen dam. So there is no negative impact.
- (18) **Noise:** Similarly there is no noise problem. Only the turbines for electricity generation may produce some noise that can be controlled and restricted in the pump house itself.
- (19) **Historical monuments:** Some historical monuments may be submerged in the reservoir. Kadana, Galiakot, Nagarjun temple are the examples. Manibeli temple has submerged in Sardar Sarovar project. Sometimes, if the monument is very important it has to be removed in pieces and rebuilt, or it has to be shifted as such with a great expense. Sometimes, a protection wall is constructed all around it to prevent the submergence under water. So the site should be selected in such a way that no such historical monument gets submerged otherwise it shall be a negative impact.
- (20) **Tourism:** Tourism shall be promoted. The plenty of water promotes the gardens, boating, adventure games, fun making, fountains and many other recreation facilities. Tourists are attracted to these things and money flows alongwith the tourists to the town. The famous Vrindavan Gardens in Mysore are constructed on Krishnarajsagar Dam. So it is a positive impact in one sense. The other point says that alongwith the tourists foreign culture also

invades the local culture. This cultural invasion is a negative impact. AIDS is most prominent in Jaisalmer out of the whole Rajasthan because of the foreign tourists attracted to the deserts of that area. So it is a combined effect and the impact has to be studied carefully considering both the points.

- (21) **Health:** The improved water supply improves the sanitation and the diseases like diarrhea are reduced as treated water is available in plenty. But as the fecal matter is mixed with the fresh bodies of water (rivers, ponds) as sewage so water is a vehicle for the bacteria and viruses of diseases like cholera, typhoid, hepatitis (Jaundice), gastroenteritis etc. These water borne diseases can be controlled only with the proper treatment of drinking water i.e. the disinfection. Some diseases like Schistosomiasis and Guinea Worm disease take place when the schist enters through the foot of a person entering in the water. As the water is used in plenty for irrigation and other works many vectors like mosquito are born in abundance and they spread the vector borne diseases like malaria, dengue, brain fever etc. This has a great negative impact. In the command area of the Indira Gandhi Main Canal Project in Western Rajasthan thousand of people die from these vector born diseases every year. However, this mortality will reduce as the population becomes trained against this as in U.P, Punjab, and other states where irrigation is there since a long time.
- (22) **Socioeconomic:** This includes all the impact on the social structure of the affected community. The main advantage of the water resource project shall be the availability of drinking water. When there is no such project, people had to fetch water from distant sources. In western Rajasthan women fetch water on their head from miles away. The male members waste their whole day in cartage of water with carts from a distant pond. The amount of water so carried was so precious and scarce that was used only for drinking, cooking and the sanitary condition was very poor. As the water resource projects comes, into existence this whole effort, time, energy and money is saved. This has its direct benefits as well as many indirect benefits. The women have time to take care of their health and education and small earnings. They can take care of their children in a better way. Men can go out and earn better as they are free from the burden of water carriage.

Besides this the irrigation water changes the whole scenario. Firm, assured substantial, cash crops make them prosperous. Every essential facility like road, electricity, telephone, vehicles, medical help, communication etc. is made available to them. Good comfortable houses are built in villages or the farms/fields there itself. This reduces the migration of rural population to the cities and develops a self reliance in them. Agro based and other industries come up in no time. The growth of self dependant villages is beneficial to the whole country.

The other side of the coin is the increase of crime rate. The prosperity breaks up the very sense of the combined village community. The pollution and other evils of urbanization are there.

The overall impact is positive as some bad effects are always associated with any development. With cautious planning and a good vision they can be overcome.

### **7.3.1.2 Hydroelectricity Project**

The other project may be a hydroelectricity project which is an extension of the water resource project. The plants are of two types, one is 'Peak Load Plant' and other is 'Joined with the Grid'. In isolated distant peak load plants whenever the necessity comes a unit is switched on and it starts suddenly. A huge quantity of water is suddenly released that may prove fatal for aquatic life as well as for human beings. The solution to this is in having an equalization tank.

Screens or trash racks placed before turbines prevent larger fish say > 5 cm. but smaller fish caught by the vortex motion go inside and are killed in the blades of turbine. But there is no thermal pollution etc. so it is comparatively cleanest technology of electricity generation.

### **7.3.1.3 Navigation Project**

The water resources project can also be used as a navigation project with a huge canal for transportation of ships, boats or directly the wood logs etc. The following are the impacts:

- Grease and oil floats on the surface of water that prevents the penetration of sunlight.
- The photosynthesis is badly affected.
- Surface water waves run along the bank and thus the banks are eroded.
- Stagnation takes place at jetties.
- Leaching of chemicals from nearby godowns takes place.
- If continued with dams, Lock Gates cause discontinuity in flow pattern.

### **7.3.1.4 Tidal Hydroelectricity Project**

Tidal hydro plants are pilot plants in the gulf of Combay. In India we have only 4 to 5 metre high tides. In this type of power plant we make a bund across the definable banks of a river where it meets the sea. The water is lifted up and down at the time of high tide and low tide. This movement is converted into electricity by the turbines. Low head turbines have been developed that can work on varying heads also. The impact areas are as follows:

- Aquatic organisms which thrive on tidal cycle are adversely affected. When they pass through turbines they die due to high speed and restricted movement.

- Salinity encroachment to ground water is increased by making the longer basin of river.
- Breeding habitats of estuarine organisms are adversely affected.

### 7.3.1.5 Wave Energy Generation

In this the energy of sea waves is converted into electricity by the turbines. The oscillating water column compresses the membrane and the compressed air moves the turbine as shown below.

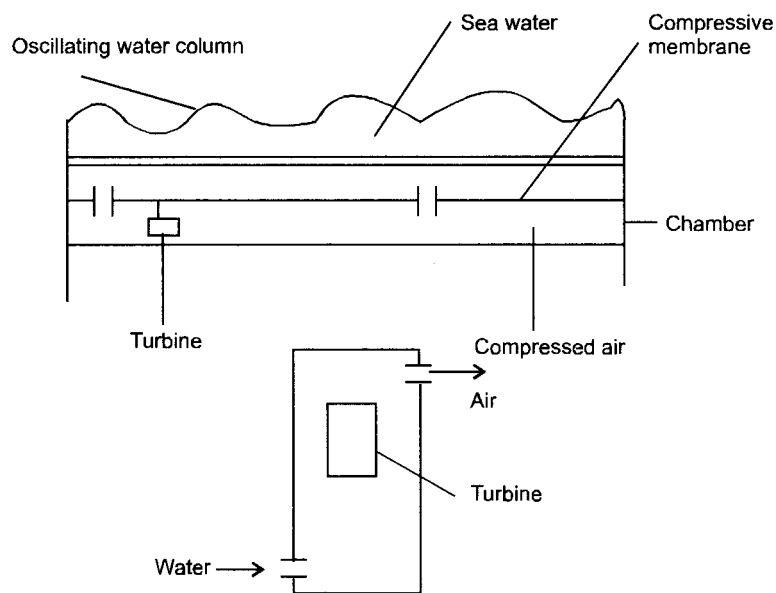

**Wave Energy Generation**

#### **Impact:**

- The traditional use of the sea shore is spoiled.
- The vertical depth of the sea is spoiled and visually also it is displeasing.

### 7.3.1.6 Wind Energy Project

A minimum velocity of 3m/sec and an average velocity of 7m/sec is required for wind energy generation. In India at present it is being developed at many places near sea shore and in the desert areas also. The impacts are as follows:

- Air borne birds are badly affected.
- It is visually unpleasing and the traditional use of the place is restricted.

### **7.3.1.7 Geothermal energy**

In this type the heat inside the deep earth is used for making steam and running the turbine. Though very small percentage of the total but at some places like Sanfransisco about 25% electricity production is by Geo thermal energy. The impacts are as follows:

- Thermal pollution is there.
- Hydrogen sulphide and other mineral obnoxious gases come out.

### **7.3.1.8 Solar energy**

Solar energy conversion into electricity by photovoltaic means and thermal means both are very good options.

The impacts are as follows:

- The pollution caused in the manufacturing of solar photovoltaic panels is tremendous.
- The solar thermal chimney based plants require a very high chimney that may be dangerous from strategic point of view.

### **7.3.1.9 Thermal power plants**

These are the most common ones. Fossil fuels like coal or oil is burnt and steam is formed and the electricity is generated in these plants. The impacts are as follows:

- The main adverse impact is the air pollution. Lot of CO and CO<sub>2</sub> are generated. CO<sub>2</sub> is the main culprit of global warming.
- Oxides of nitrogen and sulphur are liberated that cause acid rain and many diseases in human beings and even loss to the building property etc.
- In the mining of coal unsightly conditions develop. The abandoned mines collect water which produces reduction in ground water and other problems. Loss of top good soil takes place due to mining.
- The coal particles and the suspended particulate matter spread in the air up to many kilometers and the nearby residents develop many respiratory and other diseases.
- The fly ash and bottom ash generated poses a great problem of disposal. Mounds of ash are created. However, these days the cement manufacturing and brick manufacturing industries are using the fly ash in abundance.
- The hot water discharged into the reservoir pool causes thermal pollution and proves fatal to aquatic life.
- The releasing of steam produces noise pollution.

### **7.3.1.10 Nuclear Power Plant**

The nuclear energy is obtained from the isotopes of Uranium, and Thorium or Plutonium. The molecular energy is converted into heat by fission and fusion to make steam that runs the turbine for electric power generation.



1 gram of Uranium ( $U_{235}$ ) gives 72 million mega joules per second.

The waste product is radioactive and thus buried in deep sea with a few meters thick wall so that it may not come out before its half life. The waste product may cause drastic changes to ecology i.e. permanent damage.

**7.3.1.11 Biomass or Biogas Power Plant**

A very small percentage of electricity production is by making biogas or using the biomass in other ways (pallet making etc.)

The contribution is less but very valuable for isolated communities.

The biogas or the landfill gas can be produced by the biomass or the biodegradable organic portion of the solid waste. The impacts are as follows:

- Unsightly dumping of solid waste is avoided.
- Energy becomes available as a byproduct of solid waste disposal.
- However the other gases (as shown in the table below) make air pollution.
- A larger township is required and the main aspect is the biodegradability of the waste.

**Table 7.1 Desirable Composition of Landfill gas**

<b>Component</b>	<b>% by volume</b>
Methane	63.8
CO <sub>2</sub>	33.6
O <sub>2</sub>	0.1
N <sub>2</sub>	2.4
H <sub>2</sub>	< 0.05
CO	< 0.001
Saturated Hydrocarbon	< 0.001
Unsaturated Hydrocarbon	0.005
Halogenated Copper	0.009
H <sub>2</sub> S	0.00002
Organic sulphur compounds	< 0.0001

**7.3.1.12 Industries**

Various industries also require the assessment of environment impact. They have a demand of water that is known as the “specific water demand”. For example it is say 200 tons of water per ton of steel produced. This demand includes cooling, boiler steam making, processes like washing, dilution, cleaning, chemical, reaction, component or the sanitary and beautification etc. A large portion of the water used comes out as the



waste water. The industrial waste water is generally more dangerous than the domestic as it contains chemicals, heavy metals, hazardous material with high B.O.D and C.O.D.

Following is the list of industries for which the assessment is made, generally:

- Petro-chemicals
- Iron and steel
- Pulp and paper
- Agro industries
- Textile (cotton and synthetic)
- Fertilizer
- Tanning
- Cement (dry or wet)
- Pharmaceuticals.

There may be so many other industries, power plants, manufacturing units etc. that have the impact on environment. For each of them some of the identified areas may be common and some may be different. So it is necessary to know the details of the unit and then the areas are identified.

### 7.3.2 Data Collection

After the identification of impact areas the data collection is done.

Following steps are taken in the data collection:

- (a) Environmental reconnaissance
  - (b) Preliminary survey
  - (c) Detailed survey
- (a) Environmental reconnaissance:** In the initial or reconnaissance survey the following indicative list is prepared:
- (i) Name of industry
  - (ii) Category of industry (small scale, medium or heavy industry)
  - (iii) Input and output of the industry
  - (iv) Specific water demand
  - (v) Waste characteristics like pH, B.O.D<sub>5</sub>, C.O.D, total dissolved solids, total suspended solids and others.
- (b) Preliminary survey:** In this the base line survey (scoping) is done. For this purpose census data, district gazetteer, maps published by various agencies (like the G.T. Sheets published by the survey of India Department, Irrigation atlas etc.) are obtained.

- (c) **Detailed survey:** In this the field level measurements of critical time and location are done. The impact areas are identified and specific to those areas study is made by collection of samples testing and observations.

### 7.3.3 Prediction

Prediction means giving advanced information. Prediction may be qualitative as good, bad, high, low etc. or quantitative. Quantitative modeling is done for depicting the process and end results. It may be done in following ways

- Mathematical modeling
- Statistical modeling
- Regional
- Physics based

The constraints in prediction are uncertainty and inadequacy of data.

The prediction techniques are

- Modeling (empirical, statistical, mathematical)
- Superimposition
- Transposition

The mathematical modeling includes curve fitting techniques.

The curves may be like simple regression curve like

$$Y = mX + C$$

Or 
$$Y = a_0 + a_1 X + a_2 X^2$$

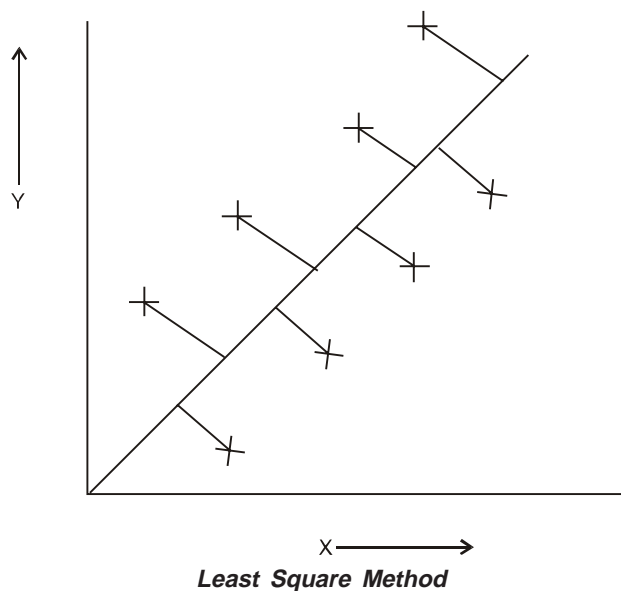

Then we plot the data and check the difference of the observed values from the plotted curve, the difference being designated as ordinates. The **least square method** suggests that the sum of squares of ordinates should be a minimum. There may be negative and positive both values. Squaring makes the negative values also positive. If we add the deviations without squaring them, the positive and negative values may adjust each others and the sum will give a misleading data. So the least square method is a good method that is reasonably accurate also.

For more accuracy the other criteria i.e. the root mean square value may be taken into consideration.

$$\text{The root mean square value} = \sqrt{(\text{observed} - \text{fitted})^2 / (n-1)}$$

where n = number of observations.

Keep on increasing the degree of curve and find out the corresponding root mean square value

Say, line give it	=	0.15
First order curve	=	0.012
Second order curve	=	0.005
Third order curve	=	0.018

It means that the second order curve is the best fitting curve as the root mean square value for it is the minimum.

In both of the above methods sometimes some values may be there that are very much away from the other values (stray item), that should be excluded as it is a misleading value. It may be there due to any mistake or un anticipated event. If we are not careful to omit such value the result may be erroneous. So the least square method is a good method but not a fool proof method.

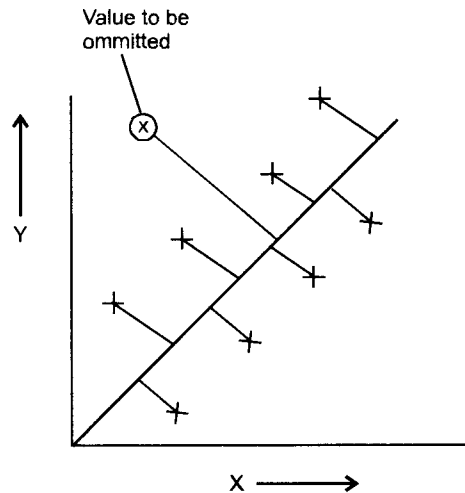

The multiple regression curves are also used as:

$$Y = (a_{11}X_1 + a_{12}X_2 + a_{13}X_3) + a_{21}X_1^2 + a_{22}X_2^2 \dots$$

The extension made may have many shapes so, transform it to straight line by selecting some other scale say logarithmic scale.

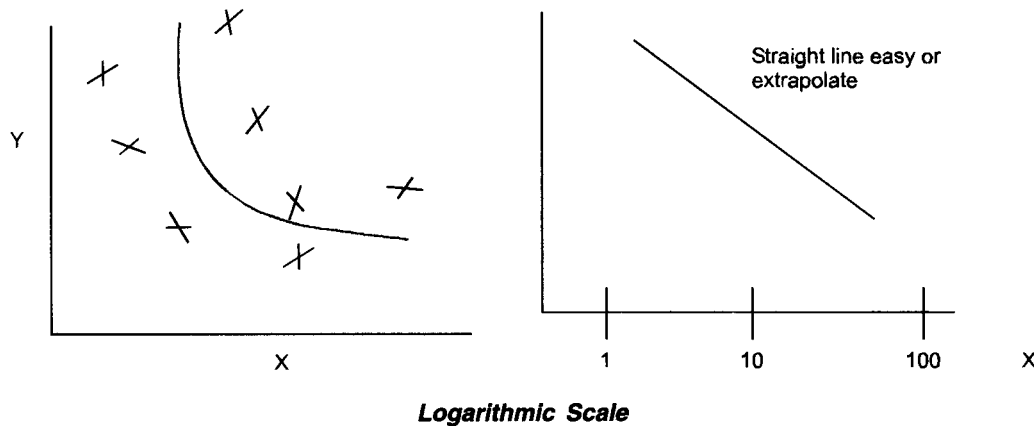

Like this the observed data is fitted in different type of suitable curves to find the conclusion.

Sometimes, the different curves so obtained are superimposed on each other to get the results. For example in the Theis' pumping test method for the determination of the aquifer constants  $S$  (Storage co-efficient) and  $T$  (Transmissibility), a type curve is plotted between  $u$  that is a function  $= r^2S/4Tt$  and its integral  $W(u)$ . Then another curve is drawn on a log-log tracing paper for the measured values of  $r^2/t$  in an observation well at various instants of time  $t$ . Keeping the co-ordinate axes of the two curves parallel, the data curve is **superimposed** on the type curve such that most of the points on the data curve fall on a segment of the type curve. Then selecting some matching points on the overlapping portion of the two curves and determining the co-ordinates from the type curve, a set of values is obtained. From these sets the values of  $S$  and  $T$  are obtained.

### 7.3.4 Assessment

After identification of the impact area, data collection and prediction of the data the final step is the assessment of the environmental impact. Actually, we have to see the importance of every point based upon the place, time and the subject on which the impact is being studied. A same point of impact may have two different values in two different cities or countries. The same may have two different value for the same city at different times. For example tourism may have a negative impact on some conventional old city too much concerned about its cultural heritage. After some years due to the expansion of knowledge media the same negative impact may not be felt for tourism in the same previously conventional city. So the final assessment of the impact is time specific and case specific.

So we have to allot some weights to every item under study for a particular case at a particular time. Here comes the vision of the assessor. For this purpose there should be a team of well qualified, experienced and honest persons alongwith the participation of the affected persons. The people's participation is a must. The policy has to be made for them, so it should be agreed upon by them and this will happen with their consent only. In other cases also when some project has been implemented and its environmental impact has to be studied it should be done in a comprehensive manner with people's participation.

Allotting weights to all the identified impact areas and then studying the combined effect to come to some conclusion is not an easy task. There are some complicated matrix methods to solve such interconnected complex problem. With the help of different computer programmes with simulation and other techniques it has become simple and possible these days. But the human wisdom is always a must for the final assessment.

#### **7.4 CONCLUSION**

For a development to be sustainable, holistic and equitable it has to coexist with the environment. In want of getting fast development the society has overlooked the environmental concern. This has forced the nature to react. The reaction is alarming and a time has come when we have to think before we implement. The assessment of impacts of any project on environment is utmost necessary. This has to be done in a scientific manner keeping the economic and social aspects into consideration. The priorities of a community or a nation may be different at different times. At the time of independence we were not technologically advanced and self dependent. The first priority was production of food grain to support such a large population. Irrigation was a must for this. Big dams like Bhakra Nangal and others were constructed. Large canals like Indira Gandhi Main Canal were also made and India became self sufficient in food sector. Many large and small industries in government and private sector came up and our country is self dependent, self reliant, self supporting country in almost all sectors. But the exponentially growing population has led to overexploitation of resources. India with 2% of the earth's habitable area has to support 15% of its population. The overexploitation of the resources has degraded the environment through out the world. The whole cyclic system of the nature is at stake. For protection of environment against this degradation and to have sustainable development we have to assess the impacts on environment before the actual implementation so that we can choose a better alternative or make some additions and deletions in the project to safeguard the environment.

For assessing it first of all we have to identify the areas over which the impact is to be studied. Then we have to collect the data regarding the identified areas. Then by the scientific analysis of the data the predictions are made. Depending upon all this exercise finally the assessment is done quantitatively and the positive and negative components of the result are weighed on the balance of wisdom. If the project passes on the importance, priority and sustainability criteria over and above the others then it is finally selected.

---

**REVIEW QUESTIONS**

1. Discuss the relation of yield and waste production in a process.
2. What is sustainable, holistic and sound development?
3. Describe the necessity of environmental impact assessment.
4. Describe in brief the methodology of environmental impact assessment.
5. What do you mean by identification of impact areas for environmental impact assessment?
6. Describe in detail the impact areas of a water resource project.
7. What are the differences of rehabilitation and resettlement?
8. What are the main problems of deciding compensation to the displaced population of a project and what are your suggestions for solving them?
9. Describe the environmental impact assessment of hydroelectricity project.
10. Describe the environmental impact assessment of navigation project.
11. Describe the environmental impact assessment of wave energy project.
12. Describe the environmental impact assessment of wind energy project.
13. Describe the environmental impact assessment of geothermal energy project.
14. Describe the environmental impact assessment of solar energy project.
15. Describe the environmental impact assessment of thermal power project.
16. Describe the environmental impact assessment of nuclear power project.
17. Describe the environmental impact assessment of biogas, biomass power project.
18. What is the desirable composition of land fillgas?
19. What are the various industries for which environmental impact assessment should be done?
20. Describe the process of data collection for environmental impact assessment.
21. Describe the prediction technologies for environmental impact assessment.
22. What is the least square method?
23. Describe the use of root mean square value in the prediction technology.
24. Describe how the final assessment of impact is done.
25. Write a note on the environmental impact assessment.

**This page  
intentionally left  
blank**

# ***NOISE POLLUTION***

---

## **8.1 INTRODUCTION**

The word noise is derived from the Latin term nausea. Noise has been defined as a sound without agreeable quality or as unwanted or undesirable sound. This is a subjective definition as some desirable sound for somebody (fast music) may be noise for some other person. So defining it in a better way we can say that noise is wrong sound in the wrong place at the wrong time. A given sound is pleasant when soft but noisy when loud. It may be acceptable for a short time but unacceptable when prolonged. It may be intriguing when rhythmic but noise when randomly repeated. Noise is defined in law as, excessive, offensive, persistent or startling sound.

Like air and water pollution noise is also emerging fast as a major pollutant to the environment. The roar of jet planes, honking of buses, the screeching of rushing vehicles, wailing of emergency vehicle sirens, whistling of railway engines, back fire from motor vehicles, the din of factories, the thunder of construction machinery, are contributing to the high level of noise. The noise is just not confined to the urban area but the countryside is also being shaken by the rattle of motorized farm implements, pump sets, tractors, and buzzing of motor vehicles etc. Alongwith these the increasing use of televisions, sound systems and loudspeakers without any check on their volume is also contributing to the growing noise levels.

Noise problem can be divided in two categories. First is the community noise wherein one is concerned with annoyance caused to people in their indoor environment. It is the intrusion of noise inside the dwellings above the allowable level mainly from vehicular traffic. The other is the intense sound that exists in some workplaces like factories and traffic islands where there is a real danger of permanent physical damage.



Prolonged exposure to excessive noise produces adverse physiological effects such as hypertension, annoyance, disturbance in sleep and deafness etc.

The noise has so far not been regarded as a fatal pollutant because so far it was within limits. Except in industrial areas and big cities noise pollution was not prominent and hence generally remained ignored from being treated as an environment pollutant. With the increasing industrialization and commercialization of society and with consequential increase in noise producing automobiles and machines, noise has become a slow poison to mankind. It is a matter of thought that whether we should accept the increased noise as a price for progress, or should shun the new technological advance all together to lead scheduled life. The other better way is to devise and implement noise controlling techniques to reduce the adverse impacts of noise.

## 8.2 LEVELS OF NOISE

The sound pressure of the faintest sound that can be heard by a normal healthy individual is about 20 micro-Pascal. The loudest sound produced by a Saturn rocket at the lift off stage is about 200 Pa. This large variation in sound pressure (varying from 20  $\mu$  Pa to 200 Pa) is usually avoided by expressing sound pressure on a scale based on the log of the ratio of the measured sound pressure and a reference standard pressure. Measurement on this scale is called levels. The sound level (L) is thus represented as,

$$L = \log_{10} Q/Q_0 \text{ (Bels)}$$

Where  $Q$  = Measured quantity of sound pressure or sound power or sound intensity.

$Q_0$  = Reference standard quantity of sound pressure.

$L$  = Sound level in Bels.

A Bel is a large unit so for convenience it is divided into 10 subunits called decibels (dB).

So when sound level is expressed in decibels.

$$L = 10 \log_{10} Q/Q_0 \text{ (dB)}.$$

According to World Health Organization (WHO) a level of 45 dB is considered a safe noise level in a city. However, a noise level of 65 dB can be tolerable as per the international standards. A report from National Physical Laboratory (India) shows that there is an increase in the background noise level at the rate of 1 dB per year.

## 8.3 THE NATURE OF SOUND

Sound is the sensation caused by a vibrating medium acting on the ear, but the term is usually applied to the vibration itself. The source of sound is most often some vibrating solid body like a string or a sheet which generates vibrations in the air, but it may be generated by vibrations of a gaseous medium, as such the air in a whistle or flute. The medium conveying it to the ear can be a gas (air) or a liquid. In which the vibrations are transmitted as a longitudinal wave motion, i.e successive compressions and rarefactions of the molecules.

The following figure shows the propagation of sound wave i.e. how these longitudinal waves are represented graphically by a sine curve.

Here,

Wavelength =  $\lambda$  in meters, it is the distance between successive peaks or troughs.

$$\text{Frequency} = f = \text{Hz ( per second)}$$

$$\text{Velocity} = V \text{ m/s}$$

$$V = f \times \lambda$$

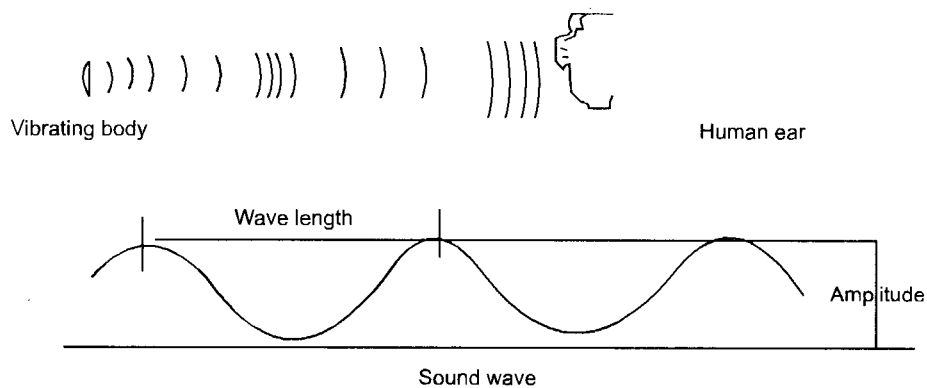

The velocity of sound in a media is inversely proportional to the density of the media and is given by the equation

$$V = \sqrt{E/\rho}$$

Where

$V$  = velocity of sound in m/sec

$E$  = young's modulus of elasticity in  $\text{N/m}^2$

$\rho$  = density of the medium in  $\text{Kg/m}^3$

The velocity of sound in air at  $20^\circ\text{C}$  is taken as 340 m/sec.

### 8.3.1 Amplitude (A)

The amplitude of the waves is the height of the peak sound pressure measured above or below the zero pressure line. The equivalent pressure of such a sine curve is represented by root mean square pressure (Prms).

$$\text{Prms} = \sqrt{1/T \int P^2(t) dt}$$

Where

$P(t)$  = Pressure at any time  $t$

### 8.3.2 Pitch

The wavelength (or the frequency) determines the pitch of the sound. Its strength is indicated by the amplitude of the sine curve.

### 8.3.3 Power and Intensity

The output of a source is measured as the rate of energy flow (i.e. power) in units of Watts (W).

The average output of some sources in Watt are as shown in the table below.

**Table 8.1 Sound Output**

<b>Source</b>	<b>Watts</b>
Jet Airliner	$10^4$
Pneumatic riveter	1
50 Kw axial fan	$10^{-1}$
Large orchestra	$10^{-2}$
Conversational speech	$10^{-5}$

In a conveying medium e.g. in air the strength of sound is usually measured as intensity, that is the density of energy flow rate through unit area in  $W/m^2$ .

When a point source emits sound uniformly in all directions in a free field, it spreads over the surface of a sphere of increasing radius. The amount of energy is distributed over a larger and larger area, therefore decreasing the intensity. As per the inverse square law the intensity at a distance  $d$  meters shall be:

$$I = W/4\pi d^2$$

Where  $I$  = Intensity in  $W/m^2$

$W$  = Power of source in Watts

Sound intensity  $I$  is related to root mean square sound pressure by the equation

$$I = P_{rms}^2 / \rho V$$

Where  $P_{rms}$  = root mean square pressure in Pascals (Pa)

$\rho$  = density of air or medium in which sound wave is traveling in  $Kg/m^3$

$V$  = velocity of sound wave in m/s

### 8.4 SENSITIVITY OF SOUND

The average person can hear frequencies from about 29 to 16000 Hz depending upon the age and other subjective factors.

The lowest intensity perceived as a sound is  $10^{-12} W/m^2$  and this is known as the standard 'threshold of audibility'.

The upper limit is the 'threshold of pain' at  $1 W/m^2$ . Vibration above this intensity would cause pain and can damage the human ear.

The following figure shows the audible range of sounds in terms of intensity and frequency:-

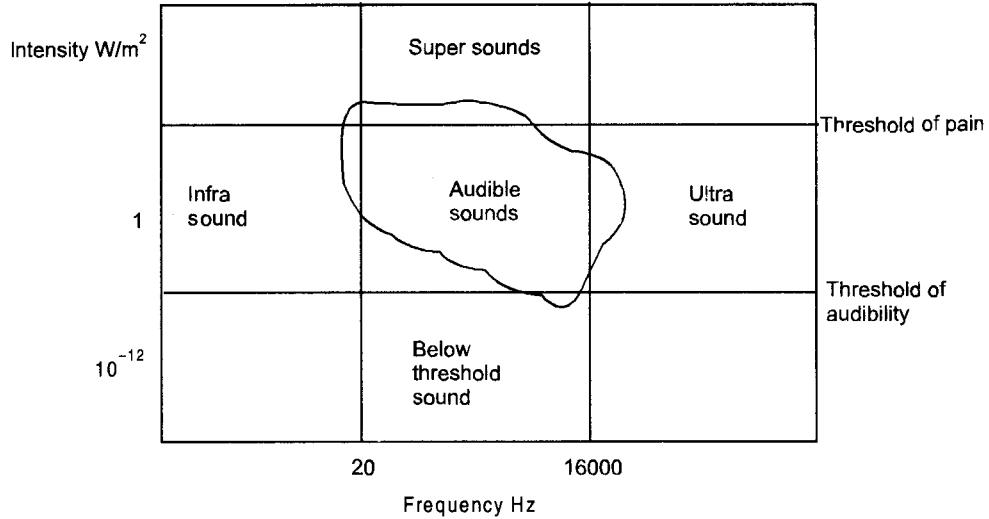

**Audible Range of Sound**

**8.5 LEVELS OF NOISE AND ITS MEASUREMENT**

The human ear has an inbuilt defense mechanism, its sensitivity decreases for higher intensity sounds. Actually, its response is proportionate to the logarithm of intensity. It is measured in decibels. The decibel is the logarithm of the ratio of the measure sound intensity and the reference intensity (audibility). The sound level L is thus represented as,

$$L = 10 \log_{10} I/I_0 \text{ (dB)}$$

Where

I = the measured intensity

I<sub>0</sub> = reference intensity : 10<sup>-12</sup> W/m<sup>2</sup>

The following table shows the intensity and consequent sound levels for some cases:

**Table 8.2 Intensity and Sound Levels**

Source of sound	Intensity in W/m <sup>2</sup>	Sound level in dB
Jet aircraft at 1 Km	0.01	100
Heavy traffic at 10 m from Kerb	0.001	90
Office with ten typewriters	0.000001	60

**Table 8.3 Noise Sources, Intensities and Bad Effects**

S. No.	Sources	Sound level dB	Perceived loudness	Damage to hearing
1	Rocket Engine	180	Painful	Traumatic injury
2	Jet plane at take-off	150	Painful	Traumatic injury
3	Pneumatic drill or aeroplane at 5m.	130	Painful	Pain and discomfort

Contd....

4	Jet take off at 100 m, thunder, pneumatic hammer	120	Painful	Deafening
5	Auto horn 1 m away	110-120	Uncomfortable	Progressive loss of hearing
6	Motorcycle 8m away	90	Uncomfortable	As above
7	Diesel truck 15m away	85	Loud	As above
8	Noisy factory, large street noise	80	Loud	As above
9	Noisy office average street noise	60-80	Loud	Damage after long exposure
10	Light traffic noise 30m away	55	Moderately loud	As above
11	Average living room	40	Quit	Damage at old age

## 8.6 ACCEPTABLE NOISE LEVELS

The following table shows the acceptable outdoor and indoor noise levels in residential areas.

*Table 8.4 Acceptable Outdoor Noise Levels in Residential Areas*

S. No.	Location	Noise level (dB)
1	Rural areas	25-35
2	Suburban area	30-40
3	Urban residential area	35-45
4	Residential and business urban areas	40-50
5	City area	45-55
6	Industrial area	50-60

*Table 8.5 Acceptable Indoor Noise Level for Various Types of Buildings*

S.No.	Location	Noise level (dB)
1	Radio and TV studios	25-30
2	Music-rooms	30-35
3	Hospitals, classrooms, auditorium	35-40
4	Apartments hotels, homes	35-40
5	Offices	40-45
6	Banks, departmental stores	45-50
7	Restaurants	50-55

The following table shows the noise produced by the home appliances.

*Table 8.6 Noise Produced by Home Appliances*

<b>S.No.</b>	<b>Noise source</b>	<b>Sound level for operator dB</b>
1	Refrigerator	40
2	Floor fan	40-70
3	Clothes dryer	55
4	Washing Machine	45-80
5	Dish washer	55-85
6	Hair dryer	60-80
7	Vacuum cleaner	62 – 85
8	Sewing machine	64-74
9	Grinder	65-95
10	Electric lawn mover	80
11	Stereo	Up to120

## 8.7 EFFECTS OF NOISE

There is a bad effect of noise on human health depending upon the noise level, exposure time and the health conditions. The effects of noise can be classified in the following ways:

- (i) **Psychological and physiological effects.-** The noise of different levels has different psychological and physiological effects. The following table shows some of them.

*Table 8.7 Effects of Noise*

<b>Noise level</b>	<b>Effects</b>
65 dB	Noise may create annoyance up to this level, but it is only psychological (nervous effect). Above this level physiological effects such as mental and physical fatigue may occur.
90 dB	Many years of exposure to such noise level would cause permanent hearing loss.
100 dB	With short period of exposure to this noise level the aural acuity may be impaired temporarily and prolonged exposure is likely to cause irreparable damage to the auditory organ.
120 dB	Short exposure cause pain and other damages to human beings.
150 dB	Causes instantaneous loss of hearing.

Actually the acceptance level of noise depends upon the state of mind and the expectation of a listener. A person can bear the monotonous sound in a sleeper coach of a train as high as 70 dB and sleep comfortably as he expects it and mentally prepared for it. The same person may get disturbed even by the ticking of a clock at 20 dB in his bedroom.

## **8.8 ADVERSE EFFECTS OF NOISE**

### **8.8.1 Effects on Human Body Function**

Exposure to noise is likely to bring about activation of sympathetic nervous system in a similar way as heat, cold, pain etc. One of the short time reactions is the change in blood circulation. The other effects on brain and other organs are the increased release of insulin in pancreas, increase in the secretion of oixitaxin and ADH from the posterior and it also decreases the detoxifying function of the liver including aromatic substances with carcinogenic effects. Long time noise can produce stomach ulcer, reduced flow of gastric juice and change in acidity neurosis, allergies and circulatory disease, abortion and other congenital defects in children, deafness etc.

### **8.8.2 Sleep Interference**

The main annoying effect of noise is the interruption on sleep. Sleep is a must and even one nights missed sleep may disturb us. One can become short tempered and weary. Noise can interfere with sleep even when the sleeping person is not awakened.

### **8.8.3 Effect on Working Efficiency**

It has been proved that the working efficiency reduces with increase in noise. Reduction in noise from 96 dB to 87 dB has increased the performance by 12%. Reduction of noise either by sound proofing or putting sound obstructing barriers improves the quality of work. It also reduces the industrial accidents. The noise affects communication signals, so reduction of noise increases the efficiency.

### **8.8.4 Effect on Wild Life**

Noise produces physiological effects on human as well as animal health. It has been surveyed that noise has adversely affected the wildlife of the country. It has been observed by the zoo authorities that animals particularly deer, lions, rhino etc. are the worst affected ones by the traffic noise. They become dull, inactive, lesser reproductive and ill. Even the migratory birds are reduced if there is noise. In the forests because of the human activity the noise increases and the animals like lion, tiger and elephants feel segmentation and their reproduction is automatically reduced.

### **8.8.5 Effects on Non-living Things**

Noise affects even the non-living things. High intensity noise may produce cracks into buildings. The noise and vibrations from machinery result in shattering of foundations, loosening of plaster and cracks in walls and house hold crockery.

## 8.9 CONTROL OF NOISE POLLUTION

Though the noise cannot be totally eliminated but can be reduced by adopting certain measures. The basic principals of noise control are as follows.

### 8.9.1 Noise Control at Source

In an industry to control the noise at source the machinery should be equipped by effective silencers, properly installed on the designed foundation and well maintained. Use of shock absorbing material, efficient flow technique, reducing fluid jet velocities, restricting sound producing area, reducing peak accelerations are some of the techniques of noise control at source. Use of guards, covers, enclosures and muffler systems, sealing all openings, use of proper cutting speeds and feed rate are other ways of noise reduction. The proper maintenance of machines by lubrication and timely replacement of bearings is the main thing required for the control of noise at source.

### 8.9.2 Noise Control along the Path

The modification of sound path includes:

- i. Use of solid high barriers to interrupt the direct transmission. Solid fences and high earth berms can be provided up to attenuation along the highways.
- ii. Increasing distance between the source and the receiver.
- iii. By planting trees. Trees are very good absorber of the sound and otherwise also very much useful as described earlier.

## 8.10 NOISE CONTROL AT RECEIVING END

- To control the noise at receiver level following measures are adopted.
- Double glazing windows in the building for improved sound proofing.
- Gasketing and sealing door and windows openings.
- Providing additional sound insulation for roofs and walls.
- Isolate the operator from the noise.
- By controlling hours of exposure to noise.
- Use of personal protective devices like ear plugs, ear defenders, disposable ear plugs etc.

## 8.11 OTHER WAYS OF NOISE CONTROL

Forming legislation for noise levels for various types of equipment, land use pattern, declaration of silence zone, restricting the use of loudspeakers are some of the ways of noise reduction. Actually, there are rules and regulations but their implementation is difficult without the co-operation of masses. Educating people about hazards of noise pollution and developing awareness at all levels can solve the problem. The social workers should come up to ban the use of bands, orchestras, D.Js in the marriages and other functions. The engineers should design the equipment with



minimum noise. The industrialists have to install and maintain the equipment & machinery properly. The vehicle drivers should owe to restrict the use of horns of their vehicles unnecessarily. The students should owe to stop the use of crackers on festivals and other moments of joy. The demonstrations should be silent ones. Society in general can reduce the noise pollution if it really wants so.

### 8.12 MEASUREMENT OF NOISE

Sound level meters are used to measure any type of sound under different conditions and for a variety of reasons. For such applications measurement technique is carefully selected and controlled to obtain valid and consistent results. The measurements are generally taken at the receivers level i.e. 1.2 m above ground (human ear position). The response of the meter depends upon the type of expected sound. The primary components of a sound level meter are microphone, single conditioning electronics and some form of filtering and an analog or digital indicator. The microphone is most important as it converts acoustic signal into electrical signal. The microphone may be a carbon microphone, condenser microphone, piezoelectric microphone or moving coil electrodynamic microphone etc. A good microphone must produce minimum diffraction. This is made possible by keeping its dimensions small compared to the wavelength of sound to be measured. Its output should not be affected by temperature, humidity, wind, atmospheric pressure and magnetic field. It should have low electrical noise and should have flat frequency response. The output should have no distortion. It should have high acoustic impedance and should be strong built.

### 8.13 CONCLUSION

The noise level is increasing day by day in urban and rural both environments. It is detrimental in many ways and particularly for human health. It causes annoyance, irritation, headache, insomnia, fatigue, mental disorders, increased perspiration, nausea, high blood pressure, high pulse rate and other human ailments. All measures should be adopted to reduce the noise at source level. If it is not possible to cut down the noise then efforts should be made to reduce it in between, by say absorption by trees. Even then if the sound reaching the listener is higher than permitted, personal protection should be done by using ear plugs or dampeners. The duty hours should be such that prolonged exposure to noise is restricted. The cities should be planned in such a way that the heavy traffic is always by passed and the other traffic should have a timely entry. The vehicles with distorted silencers should be heavily panelized. Overloaded trucks produce more noise. Use of horns should be limited and the pressure horns should be totally banned. Use of loudspeakers should be banned and all processions on the roads should be banned. Use of fire crackers making loud sound, on festivals and other events should be restricted by law, rather banning their production. Sound proofing should be done in factories and industries and offices. By adopting all these measures the aim of noise control can be achieved.

**REVIEW QUESTIONS**

1. What do you understand by noise pollution?
2. What is the meaning of noise level? Describe the term decibel.
3. Describe the term nature of sound.
4. What is amplitude and pitch of sound?
5. Tabulate the sound outputs of various sources.
6. Describe the sensitivity of sound.
7. What is the level of sound and its measurement?
8. Describe the effects of noise.
9. Discuss the various means of control of noise pollution.
10. Describe the ways of measurement of noise.
11. Name the various diseases caused due to noise.
12. Tabulate the acceptable indoor noise levels.
13. Tabulate the acceptable outdoor noise levels.
14. Tabulate the noise level data produced by home appliances.

**This page  
intentionally left  
blank**

# BIBLIOGRAPHY

---

Arcadio P. Sincero & Gregoria A. Sincero (1999), *Environmental Engineering: A Design Approach*, Prentice Hall of India Pvt. Ltd., New Delhi.

Arora, K. R. (2001), *Irrigation Water Power and Water Resources Engineering*, Standard Publishers Distributors, Delhi.

Banerjy, Samir K. (1997), *Environmental Chemistry*, Prentice Hall of India Pvt. Ltd., New Delhi.

Benny Joseph (2005), *Environmental Studies*, Tata McGraw-Hill Publishing Company Limited, New Delhi.

Dash, M.C. (2004), *Ecology, Chemistry & Management of Environmental Pollution*, Macmillan India Ltd., Delhi.

Dash, M.C. (1993), *Fundamentals of Ecology*, Tata McGraw-Hill Publishing Company Limited, New Delhi.

Das, R.R. (2006), *Environmental Studies*, Paragon International Publishers, Delhi.

De, Anil Kumar. De, Arnab Kumar (2005), *Environmental Studies*, New Age International (P) Limited Publishers, Delhi.

Deswal, S.S. Deswal S.(2001), *Environmental Engineering*, Dhanpat Rai.Co, Delhi.

Deswal, S. & Deswal, A. (2004), *A Basic Course in Environmental Studies*, Dhanpat Rai & Co, Delhi.

Dhameja, K. Suresh.(2000), *Environmental Engineering and Management*, S.K. Kataria & Sons, Delhi.

Dutta, Subijoy (2002), *Environmental Treatment Technologies For Hazardous And Medical Waste Remedial Scope and Efficacy*, Tata McGraw-Hill Publishing Company Limited, New Delhi.

Edward, J. Kormandy (1991), *Concepts of Ecology*, Prentice-Hall of India Pvt. Ltd., New Delhi.

Eugene, P. Odum (1975), *Ecology*, Oxford and IBH Publishing Co. Pvt. Ltd., New Delhi.

Goel, P. K. (2006), *Water Pollution: Causes, Effects and Control*, New Age International Publishers (P) Ltd., New Delhi.

Garg, Santosh Kumar (1992), *Water Supply Engineering*, Khanna Publishers Delhi.

Hempel, C. Lemont (1998), *Environmental Governance: The Global Challenge*, Affiliated East West Press Pvt. Ltd., New Delhi.

Kurian, Joseph and R. Nagendran (2004), *Essentials of Environmental Studies*, Pearson Education (Singapore), Delhi.

Kaushik, Anubha & Kaushik C.P.(2006), *Perspective in Environmental Studies*, New Age International (P) Limited Publishers, Delhi.

Khopakar, S.M (2005), *Environmental Pollution: Monitoring and Control*, New Age International Pvt. Ltd. Publishers, New Delhi.

*Manual on Water Supply & Treatment*, Dec. (1984), Central Public Health And Environmental Engineering Organisation, Government of India, Ministry of Urban Development, New Delhi.

*Manual on Sewerage and Sewage Treatment*, Dec. (1993), Central Public Health And Environmental Engineering Organisation, Government of India, Ministry of Urban Development, New Delhi.

*Manual on Solid Waste Management* (2005), Central Public Health And Environmental Engineering Organisation, Government of India, Ministry of Urban Development, New Delhi.

Mark, J. Hammer & Mark, J. Hammer, Jr (1998), *Water and Wastewater Technology*, Prentice Hall of India Pvt. Ltd., New Delhi.

Punmia, B.C and Jain Ashok & Jain Arun, (1995), *Environmental Engineering I, Water Supply Engineering*, Laxmi Publications Pvt. Ltd., New Delhi.

Punmia, B.C. and Jain Ashok, (1998), *Environmental Engineering II, Waste Water Engineering*, Laxmi Publications Pvt. Ltd., New Delhi.

P. Venugopala Rao (2003), *Textbook of Environmental Engineering*, Prentice Hall of India Pvt. Ltd., New Delhi.

Rana, S.V.S.(2003), *Essentials of Ecology and Environmental Science*, Prentice Hall of India Pvt. Ltd., New Delhi.

R. Rajagopalan (2006), *Environmental Studies From Crisis to Cure*, Oxford University Press, New Delhi.

Rao M.N & Rao H.V.N (1996), *Air Pollution*, Tata McGraw-Hill Publishing Company Limited, New Delhi.

Rao, C.S.(2006), *Environmental Pollution Control Engineering*, New Age International Pvt. Ltd. Publishers, New Delhi.

Syed R. Quasim, Edward M. Moteley and Guang Zhu, (2002), *Water Works Engineering: Planning Design and Operation*, Prentice Hall of India Pvt. Ltd., New Delhi.

Subrahamanyam N. S. & Sambamurty A.V.S.S (2000), *Ecology*, Narosa Publishing House, New Delhi.

Trivedi R.K. and Goel, P. K. (2005), *An Introduction to Air Pollution*, B.S. Publications, Hyderabad.

Vesilind P.Arne & Worrell, Willim & Reinhart. (2004), *Solid Waste Engineering*, Thomson Brooks/Cole, Printed at Eastern Press, Bangalore.

Vesilind P. Aarne and Morgan M. Susan. (2004), *Introduction to Environmental Engineering*, Thomson Brooks/Cole, Eastern Press, Bangalore.

Subramanian V. (2002), *A Textbook in Environmental Science*, Narosa Publishing House, New Delhi.

Anjaneyulu Y. (2005), *Introduction to Environmental Science*, B.S. Publications, Hyderabad.

**This page  
intentionally left  
blank**

# INDEX

---

## A

Abiotic 116, 161  
Abiotic environment 2, 23  
Acceptable noise levels 188, 190  
Acid fermentation 60  
Acid rain 80  
Activated sludge process 58  
Acts and regulations 6  
Adverse effects of noise 190  
Aerated lagoons 58  
Aeration 45, 57  
Aero generator/hybrid systems 158  
Aerosols 71  
Agrochemicals 169  
Air pollution 70  
Air quality 170  
Akshya urja shops 158  
Algae 62  
Animal husbandry 168  
Aquatic ecology 120  
Area elevation curve 20  
Area source 74  
Assessment 164  
Attenuation 191  
Autecology 119  
Automobile pollution 78

## B

Bacteriological standards 37  
Basics of species 122  
Bel 184  
Bio gas 61  
Bio-chemical oxygen demand 55

Bio-medical waste 110  
Biodiversity 140  
Biomass 156  
Biomass or biogas power plant 175  
Biome 131, 119  
Biotic 116, 161  
Biotic environment 2  
Blue-green 62

## C

Carbon cycle 128  
Carbon monoxide 72  
Carbonaceous 56  
Catalytic converter 78  
Central pollution control board 9  
Cesspools 63  
Characteristics of municipal solid waste 93  
Chemical characteristics 39  
Chlorides 40  
Chlorination 57  
Chlorofluorocarbons 3, 82  
Climax 141  
CNG 78  
Co-efficient of runoff 53  
Coagulation 43  
Coliform bacterial 62  
Community 118  
Composting 105  
Compressed air method 27  
Compressions 184  
Confined aquifer 27  
Connective precipitation 15  
Consumers 123  
Consumptive use 163



Control of pollution act 50  
Cultural invasion 171  
Cyclic operation of ecosystems 124  
Cyclone separators 77  
Cyclonic precipitation 14

**D**

Data collection 164  
Decibel 79, 84  
Deforestation 169  
Demineralization or deionisation process 48  
Deserts 137  
Detachable joints 55  
Discoloration 77  
Disinfection 44, 58  
Dissolved oxygen 56, 67  
District advisory committees 158  
Drilling of tube-wells 23  
DTH 25  
Dynamic equilibrium 161

**E**

Earth dam 19  
Earth's house 115  
Ecological study 117  
Ecology 169  
Ecosystem 118  
Effluent 61  
Effluent discharge standards 64  
Eisenia sp 106  
Electrostatic precipitators 77  
Embrittlement, 77  
Energy flow 132  
Energy parks 158  
Energy recovery 100, 103  
Environment (protection) act 1986, 50  
Environment 2, 119  
Environmental cost 165  
Environmental factors 2  
Environmental impact assessment 163, 164  
Environmental pollution 2  
Environmental protection laws in india 7  
Equitable development 163  
Estuaries 136  
Estuarine fish 169

Eutrophic 62  
Eutrophication 61, 167  
Evapotranspiration 14  
Evolution 142

**F**

Fertility 168  
Fibrosis, asbestosis 76  
Filtration 43  
Floods and droughts 166  
Flow of energy 121  
Flyash 101  
Forests 4, 139, 169  
Fossil fuels 6  
Foul wastewater 51

**G**

Garbage 87  
Gene ecology 121  
Geological cycle 125  
Geothermal energy 156, 174  
Global phosphorus cycle 130  
Global warming 3, 69, 79  
Grasslands 138  
Gravity dam 19  
Greenhouse effect 79  
Ground water yield 22  
Guinea worm disease 171

**H**

Habitat 118  
Hardness of water 40  
Hazardous waste management 109  
Hazardous waste 91  
Historical monuments 170  
Holistic 161  
Holistic development 163  
Humus 61, 164  
Hydrocarbons 75  
Hydroelectricity project 172  
Hydrological cycle 1, 3, 125

**I**

Identification 164  
Importance of trees 126

Incineration 57, 103  
Indoor noise level 188

**J**

Joined with the grid 172

**L**

Lakes and ponds 137  
Landfill 104  
Landfill gas 175, 201  
Least square method 177  
Lime-soda process 47  
London smog 74

**M**

M.O.E.F. 9  
Malthusian logical modelling 144  
Malthusian model 143  
Manhole 52  
Manning's co-efficient 55  
Manning's formula 54  
Marine echo system 62  
Mathematical modeling 177  
Mesophilic 61  
Methane fermentation. 60  
Methyl isocyanate 71  
Microclimatic changes 163, 166  
Micronutrients 63  
Microphone 192  
Migration 171  
Mineralisation 62  
Minimization at the source 100  
Ministry of non-conventional energy resources 6  
Mobile source 74  
Montreal protocol

**N**

Narmada valley development project 164  
Natural contaminants 72  
Navigation project 172  
Niche 2, 118  
Nightsoil 88  
Nitrogen cycle 129  
Nitrogenous 56  
Noise 79, 183

Noise produced by home appliances 189  
Noise 170  
Non foul wastewater 5, 51  
Nuclear power plant 174  
Nutrient cycles 1

**O**

Ocean thermal energy conversion 156  
Oikologie 115  
Oligotropic 62  
Order 142  
Organic manure 169  
Organic pollution 62  
Organisms 119  
Orographic precipitation 15  
Orthotolidine test 45  
Outdoor noise levels 188  
Outfall 62  
Oxidation ponds 58  
Oxides of nitrogen 72  
Ozone 73  
Ozone depletion 82  
Ozone hole

**P**

Packing 142  
Palaecology 121  
Pan (peroxy acetylene nitrate) 73  
Passive solar 152  
Peak factor 53  
Peak load plant 172  
Percussion drilling 24  
Permeability 21  
pH of water 39  
Phase transfer 57  
Photochemical smog 73  
Photosynthesis 62, 167  
Physical and chemical standards 36  
Physical characteristics 38  
Piped water supply schemes 34  
Pitch 185  
Plain sedimentation 43  
Point source 74  
Pollution 130  
Population analysis 142

Population characteristics 142  
Population dynamics 143  
Population interactions 121  
Population 119, 142, 164  
Porosity 21  
Potential of wind power 157  
Prediction 164, 177  
Pressure of water 48  
Prevention of pollution 49  
Pump and tank schemes 33

**Q**

Quantities of solid waste

**R**

Rainfall 15  
Rarefactions 184  
Rational method 16, 52  
Reconnaissance 176  
Regional water supply schemes 33  
Regulation of population 143  
Rehabilitation 166  
Renewable sources of energy 151  
Resettlement 165  
Respiration 62  
Rock fill dam 19  
Rotary drilling 25  
Rubbish 87  
Runoff 52

**S**

Saline soil 168  
Sanitary landfill 108  
Sanitation 5, 171  
Saprotrophs 124  
Savannah 131  
Scavengers 162  
Schistomiasis 171  
Screening 42  
Sea as an ecosystem 136  
Sedimentation 57, 169  
Seismicity 170

Self cleansing velocity 54  
Self purification of water 56  
Self reliance 171  
Septic tanks 59, 64  
Sewerage system 52, 168  
Sewerless sanitation 66  
Shrouding 26  
Simon's rain gauge 15  
Skin cancer 83  
Smog 71  
Soak pits 65  
Soil erosion 168  
Solar chimney 152  
Solar cookers 158  
Solar energy 133, 174  
Solar photovoltaic 151  
Solar photovoltaic pumps 158  
Solar power plants 158  
Solar thermal 151  
Solar water heating systems 158  
Solid waste 87  
Somatic 76  
Sound development 162  
Sound insulation 191  
Sound level meters 192  
Sound output 186  
Species 117  
Specific retention 23  
Specific water demand 175  
State pollution control board 9  
Statistical modeling 177  
Storage capacity of reservoirs 19  
Storm 52  
Storm frequency 53  
Streams and rivers 136  
Strength of the sewage 56  
Succession 119  
Sulphur cycle 129  
Sulphur dioxide 72  
Supersonic transport 83  
Surface sources 13  
Surging method 26

Sustainable development 150, 162  
Synecology 1

**T**

Taiga forests 139  
Temperate forests 139  
Temperate shrub forest 140  
Terrestrial ecology 120  
Thermal power plants 174  
Thermophilic 61  
Threshold of audibility 186  
Threshold of pain 186  
Tidal hydroelectricity project 172  
Tipping bucket gauge 16  
Toxic materials 36  
Traditional source scheme 33  
Transportation of solid waste 102  
Trap 51  
Treatment of solid waste 102  
Trees 4  
Trickling filter 58  
Tropical rainforest 139  
Tropical savannah 140  
Tundras 1

**U**

Unconfined aquifer 27  
Underground sources 14  
Union carbide 71  
Unit operations 57  
Urban water supply schemes 32, 34

Utilization of waste

**V**

Vector borne diseases 171  
Vehicular emissions 75  
Vermi-composting 101  
Vermicompost 169

**W**

Waste management approach 98  
Waste water management 49, 51  
Wastewater 51  
Water (prevention and 49  
Water borne diseases 171  
Water carriage system 66  
Water hyacinth 156, 167  
Water logging 163, 167  
Water resource project 164  
Water softening 46  
Wave energy generation 173  
Wind energy 153  
Wind energy project 173  
Wind farms 153  
Wind pumps 1

**Y**

Yield of a tube-well

**Z**

Zeolite process