



Technology Roadmap

Nuclear Energy



INTERNATIONAL ENERGY AGENCY

The International Energy Agency (IEA), an autonomous agency, was established in November 1974. Its mandate is two-fold: to promote energy security amongst its member countries through collective response to physical disruptions in oil supply and to advise member countries on sound energy policy.

The IEA carries out a comprehensive programme of energy co-operation among 28 advanced economies, each of which is obliged to hold oil stocks equivalent to 90 days of its net imports.

The Agency aims to:

- Secure member countries' access to reliable and ample supplies of all forms of energy; in particular, through maintaining effective emergency response capabilities in case of oil supply disruptions.
- Promote sustainable energy policies that spur economic growth and environmental protection in a global context – particularly in terms of reducing greenhouse-gas emissions that contribute to climate change.
- Improve transparency of international markets through collection and analysis of energy data.
- Support global collaboration on energy technology to secure future energy supplies and mitigate their environmental impact, including through improved energy efficiency and development and deployment of low-carbon technologies.
- Find solutions to global energy challenges through engagement and dialogue with non-member countries, industry, international organisations and other stakeholders.

IEA member countries are: Australia, Austria, Belgium, Canada, the Czech Republic, Denmark, Finland, France, Germany, Greece, Hungary, Ireland, Italy, Japan, Korea (Republic of), Luxembourg, the Netherlands, New Zealand, Norway, Poland, Portugal, the Slovak Republic, Spain, Sweden, Switzerland, Turkey, the United Kingdom and the United States. The European Commission also participates in the work of the IEA.

NUCLEAR ENERGY AGENCY

The OECD Nuclear Energy Agency (NEA) was established on 1 February 1958 under the name of the OEEC European Nuclear Energy Agency. It received its present designation on 20 April 1972, when Japan became its first non European full member. NEA membership today consists of 28 OECD member countries: Australia, Austria, Belgium, Canada, the Czech Republic, Denmark, Finland, France, Germany, Greece, Hungary, Iceland, Ireland, Italy, Japan, Korea (Republic of), Luxembourg, Mexico, the Netherlands, Norway, Portugal, the Slovak Republic, Spain, Sweden, Switzerland, Turkey, the United Kingdom and the United States. The European Commission also takes part in the work of the Agency.

The mission of the NEA is:

- To assist its member countries in maintaining and further developing, through international co-operation, the scientific, technological and legal bases required for a safe, environmentally friendly and economical use of nuclear energy for peaceful purposes.
- To provide authoritative assessments and to forge common understandings on key issues, as input to government decisions on nuclear energy policy and to broader OECD policy analyses in areas such as energy and sustainable development.

Specific areas of competence of the NEA include safety and regulation of nuclear activities, radioactive waste management, radiological protection, nuclear science, economic and technical analyses of the nuclear fuel cycle, nuclear law and liability, and public information. The NEA Data Bank provides nuclear data and computer program services for participating countries.

In these and related tasks, the NEA works in close collaboration with the International Atomic Energy Agency in Vienna, with which it has a Co-operation Agreement, as well as with other international organisations in the nuclear field.

ORGANISATION FOR ECONOMIC CO-OPERATION AND DEVELOPMENT

The OECD is a unique forum where the governments of 31 democracies work together to address the economic, social and environmental challenges of globalisation. The OECD is also at the forefront of efforts to understand and to help governments respond to new developments and concerns, such as corporate governance, the information economy and the challenges of an ageing population. The Organisation provides a setting where governments can compare policy experiences, seek answers to common problems, identify good practice and work to co-ordinate domestic and international policies.

The OECD member countries are: Australia, Austria, Belgium, Canada, Chile, the Czech Republic, Denmark, Finland, France, Germany, Greece, Hungary, Iceland, Ireland, Italy, Japan, Korea, Luxembourg, Mexico, the Netherlands, New Zealand, Norway, Poland, Portugal, the Slovak Republic, Spain, Sweden, Switzerland, Turkey, the United Kingdom and the United States. The European Commission takes part in the work of the OECD.

OECD Publishing disseminates widely the results of the Organisation's statistics gathering and research on economic, social and environmental issues, as well as the conventions, guidelines and standards agreed by its members.

Foreword

Current trends in energy supply and use are patently unsustainable – economically, environmentally and socially. Without decisive action, energy-related emissions of carbon dioxide (CO₂) will more than double by 2050 and increased oil demand will heighten concerns over the security of supplies. We can and must change our current path, but this will take an energy revolution and low-carbon energy technologies will have a crucial role to play. Energy efficiency, many types of renewable energy, carbon capture and storage, nuclear power and new transport technologies will all require widespread deployment if we are to reach our greenhouse-gas emission goals. Every major country and sector of the economy must be involved. The task is also urgent if we are to make sure that investment decisions taken now do not saddle us with sub-optimal technologies in the long term.

There is a growing awareness of the urgent need to turn political statements and analytical work into concrete action. To spark this movement, at the request of the G8, the International Energy Agency (IEA) is developing a series of roadmaps for some of the most important technologies. These roadmaps provide solid analytical footing that enables the international community to move forward on specific technologies. Each roadmap develops a growth path for a particular technology from today to 2050, and identifies technology, financing, policy and public engagement milestones that need to be achieved to realise the technology's full potential. Roadmaps also include special focus on technology development and diffusion to emerging economies. International collaboration will be critical to achieve these goals.

This nuclear energy roadmap has been prepared jointly by the IEA and the OECD Nuclear Energy Agency (NEA). Unlike most other low-carbon energy sources, nuclear energy is a mature technology that has been in use for more than 50 years. The latest designs for nuclear power plants build on this experience to offer enhanced safety and performance, and are ready for wider deployment over the next few years. Several countries are re-activating dormant nuclear programmes, while others are considering nuclear for the first time. China in particular is already embarking on a rapid nuclear expansion. In the longer term, there is great potential for new developments in nuclear energy technology to enhance nuclear's role in a sustainable energy future.

Nevertheless, important barriers to a rapid expansion of nuclear energy remain. Most importantly, governments need to set clear and consistent policies on nuclear to encourage private sector investment. Gaining greater public acceptance will also be key, and this will be helped by early implementation of plans for geological disposal of radioactive waste, as well as continued safe and effective operation of nuclear plants. In addition, industrial capacities and skilled human resources will have to grow to meet the needs of an expanding nuclear industry. Achieving the vision of 1 200 GW of nuclear capacity by 2050 will require all stakeholders in government, research organisations, industry, the financial sector and international organisations to work together. This roadmap sets out the steps they will need to take over the coming years.

Nobuo Tanaka
Executive Director, IEA

Luis Echávarri
Director General, NEA

Acknowledgements

This publication was prepared by the Nuclear Energy Agency's Nuclear Development Division and the International Energy Agency's Energy Technology Policy Division. Bo Diczfalusy, Director of the Directorate of Sustainable Energy Policy and Technology, Peter Taylor, Head of the Energy Technology Policy Division, and Tom Kerr, Co-ordinator of the Energy Technology Roadmaps project, provided important guidance and input.

Martin Taylor of the NEA and Cecilia Tam of the IEA were the lead authors for this roadmap. Other contributors were Steven Lee of the IEA, and Stan Gordelier and Evelyne Bertel of the NEA. Delphine Grandrieux, Corinne Hayworth and Bertrand Sadin provided layout and graphic design support.

This work was guided by the IEA Committee on Energy Research and Technology and the NEA Committee for Technical and Economic Studies on Nuclear Energy Development and the Fuel Cycle. Their members provided important feedback and comments that helped to improve the document.

This roadmap has also benefited greatly from the comments, ideas and guidance provided by experts from industry, governments and non-governmental organisations who attended the workshops and reviewed the drafts. The authors wish to thank all of those who contributed, who are too numerous to be named individually. Special thanks are due to the World Nuclear Association for hosting one of the workshops and organising industry participation, and to Steven Libbrecht and Peter van Veen of De Ruijter Strategy for facilitating the workshops.

For more information on this document, contact:

Cecilia Tam, IEA Secretariat
Tel.+33 1 40 57 67 55
Email: cecilia.tam@iea.org

Martin Taylor, NEA Secretariat
Tel +33 1 45 24 10 67
Email: martin.taylor@oecd.org

Key findings

- The present status of nuclear energy technology is the result of over 50 years of development and operational experience. The latest designs for nuclear power plants, now under construction, incorporate lessons learned from this experience as well as recent technological developments to offer enhanced safety and performance. Nuclear power is a mature low-carbon technology that is already available today for wider deployment.
- In line with the IEA's *ETP 2010 BLUE* Map scenario for a 50% cut in energy-related carbon dioxide (CO₂) emissions, this roadmap targets nuclear capacity of 1 200 GW by 2050, providing around 24% of global electricity (up from 370 GW providing 14% of electricity at present). This would make nuclear power the single largest source of electricity at that time, and hence a major contributor to the "decarbonisation" of electricity supply.
- This level of nuclear energy deployment will not require major technological breakthroughs. The obstacles to more rapid nuclear growth in the short to medium term are primarily policy-related, industrial and financial. However, continuous development of reactor and fuel cycle technologies will be important if nuclear energy is to achieve its full potential in competition with other low-carbon energy sources.
- A clear and stable commitment to nuclear energy, as part of a national strategy to meet energy policy and environmental objectives, is a prerequisite for a successful nuclear programme. Effective and efficient legal and regulatory frameworks also need to be in place. Particularly in countries launching or re-activating nuclear programmes, governments will need to take an active role, working with all stakeholders to overcome obstacles.
- Financing the very large investments needed to build nuclear power plants will be a major challenge in many countries. Private sector investors may view nuclear investments as too uncertain, at least until there is a track record of successful recent nuclear projects. Government support, such as loan guarantees, may be needed in some cases. Price stability in electricity and carbon markets will also encourage investment in nuclear plants.
- Global industrial capacity to construct nuclear power plants will need to double by 2020 if nuclear capacity is to grow in the 2020s and beyond as projected in the *BLUE* Map scenario. Fuel cycle capacities, including for uranium production, must also increase accordingly. This will require large investments over the next few years that will only proceed once it is clear that sufficient orders are on the horizon.
- An expanding nuclear industry will need greatly increased human resources, including highly qualified scientists and engineers and skilled crafts-people. Utilities, regulators, governments and other stakeholders will also need more nuclear specialists. Industry recruitment and training programmes will need to be stepped up. Governments and universities also have a vital role to play in developing human resources.
- The management and disposal of radioactive wastes is an essential component of all nuclear programmes. In particular, progress needs to be made in building and operating facilities for the disposal of spent fuel and high-level wastes. While solutions are at an advanced stage of technological development, there are often difficulties in gaining political and public acceptance for their implementation.
- The international system of safeguards on nuclear technology and materials must be maintained and strengthened where necessary. The physical protection of nuclear sites and materials must also be ensured. Avoiding the spread of sensitive technologies while allowing access to reliable fuel supplies will be a growing challenge. These issues need to be addressed through international agreements and co-operation.
- Several technologies under development for next-generation nuclear systems offer the potential for improved sustainability, economics, proliferation resistance, safety and reliability. Some will be suited to a wider range of locations and to potential new applications. Each involves a significant technological step, and will require full-scale demonstration before commercial deployment. Such systems could start to make a contribution to nuclear capacity before 2050.

Table of contents

Foreword	1
Acknowledgements	2
Key findings	3
Table of contents	4
Introduction	5
The Energy Technology Roadmaps project	5
Opportunities and challenges for nuclear expansion	5
Purpose of the roadmap	7
The status of nuclear energy today	9
Managing the existing nuclear fleet	9
Nuclear energy technology for near-term deployment	12
Status of the nuclear fuel cycle	14
The management of radioactive waste	15
Nuclear energy deployment to 2050: actions and milestones	17
Nuclear capacity growth in the BLUE Map scenario	17
The outlook for nuclear expansion to 2020	18
Preparing for more rapid deployment after 2020	19
Nuclear fuel cycle requirements	21
Technology development and deployment: actions and milestones	25
Evolutionary development of current technologies	25
Implementing solutions for disposal of spent fuel and high-level waste	25
Developing a new generation of nuclear technologies	27
Status and potential of small modular reactors	32
Nuclear energy as an alternative for heat and transport	33
Policy, financial and social aspects: actions and milestones	35
The importance of strong policy support	35
Establishing the legal and regulatory frameworks	35
Financing new nuclear power plants	37
Involvement of civil society	39
Capacity building in countries planning a nuclear programme	39
Non-proliferation, physical protection and security of nuclear fuel supply	40
Roadmap action plan	41
Actions led by governments and other public bodies	41
Actions led by the nuclear and electricity supply industries	43
Actions led by other stakeholders	44
References	47

Introduction

The Energy Technology Roadmaps project

There is a pressing need to accelerate the development of advanced clean energy technologies to address the global challenges of energy security, climate change and sustainable development. This challenge was acknowledged by Ministers from G8 countries, China, India and Korea, at their meeting in June 2008 in Aomori, Japan, when they asked the IEA to prepare roadmaps to advance innovative energy technology.

“We will establish an international initiative with the support of the IEA to develop roadmaps for innovative technologies and co-operate upon existing and new partnerships, including carbon capture and storage (CCS) and advanced energy technologies. Reaffirming our Heiligendamm commitment to urgently develop, deploy and foster clean energy technologies, we recognise and encourage a wide range of policy instruments such as transparent regulatory frameworks, economic and fiscal incentives, and public/private partnerships to foster private sector investments in new technologies....”

To achieve this ambitious goal, the IEA is developing a series of Energy Technology Roadmaps covering 19 demand-side and supply-side technologies. The overall aim is to advance global development and uptake of key technologies needed to reach a 50% CO₂ emissions reduction by 2050. The IEA is leading the development of these roadmaps, under international guidance and in close consultation with industry. This nuclear energy roadmap has been prepared jointly by the IEA and the OECD Nuclear Energy Agency (NEA).

The roadmaps will enable governments and industrial and financial partners to identify steps needed and implement measures to accelerate the required technology development and uptake. This process starts with providing a clear definition of the elements needed for each roadmap. The IEA has defined an energy technology roadmap as:

“... a dynamic set of technical, policy, legal, financial, market and organisational requirements identified by the stakeholders involved in its development. The effort shall lead to improved and enhanced sharing and collaboration of all related technology-specific research, development, demonstration and deployment (RDD&D) information among participants. The goal is to accelerate the overall RDD&D process in order to deliver an earlier uptake of the specific technology into the marketplace.”

Each roadmap identifies major barriers, opportunities and measures for policy makers and industrial and financial partners to accelerate RDD&D efforts for specific clean technologies on both the national and international level.

Opportunities and challenges for nuclear expansion

The analysis in *Energy Technology Perspectives 2010 (ETP)* (IEA, 2010) projects that energy-related CO₂ emissions will double from 2005 levels by 2050 in the Baseline scenario, which assumes no new policies and measures to curb such emissions. Addressing this projected increase will require an energy technology revolution involving a portfolio

Energy Technology Perspectives 2010 BLUE Map scenario

This roadmap outlines a set of quantitative measures and qualitative actions that define one global pathway for nuclear power deployment to 2050. It takes as a starting point the IEA *Energy Technology Perspectives (ETP)* BLUE Map scenario, which describes how energy technologies may be transformed by 2050 to achieve the global goal of reducing annual CO₂ emissions to half that of 2005 levels. The model is a bottom-up MARKAL model that uses cost optimisation to identify least-cost mixes of energy technologies and fuels to meet energy demand, given constraints such as the availability of natural resources. The ETP model is a global 15-region model that permits the analysis of fuel and technology choices throughout the energy system. The model's detailed representation of technology options includes about 1 000 individual technologies. The model has been developed over a number of years and has been used in many analyses of the global energy sector. In addition, the ETP model was supplemented with detailed demand-side models for all major end-uses in the industry, buildings and transport sectors.

of solutions, such as greater energy efficiency, increased use of renewable energies, the capture and storage of CO₂ from remaining fossil-fuelled capacity, and the greater use of nuclear energy.

The ETP BLUE Map scenario, which assesses strategies for reducing energy-related CO₂ emissions by 50% from 2005 levels by 2050, concludes that nuclear power will have a large role to play in achieving this goal in the most cost-effective manner (Figure 1). Nuclear capacity is assumed to reach about 1 200 GW by 2050, providing about 24% of global electricity supply. This is almost double its level of 610 GW in the Baseline scenario.

The BLUE Map analysis assumes constraints on the speed with which nuclear capacity can be deployed. However, the ETP BLUE High Nuclear scenario shows that assuming a larger nuclear capacity, providing around 38% of global electricity by 2050, would reduce the average electricity generation cost in 2050 by about 11%, compared with the BLUE Map scenario. An expansion of nuclear energy is thus an essential component of a cost-effective strategy to achieve substantial global emissions reductions.

Nuclear energy is at a very different stage of technological development and deployment than most other low-carbon energy sources.

Although the growth of nuclear energy has stalled in the last two decades, it is a mature technology with more than 50 years of mature commercial operating experience that does not require major technological breakthroughs to enable its wider deployment. The latest designs for nuclear power plants, of which the first examples are now under construction, aim to provide enhanced levels of safety and performance.

Despite being an established technology, achieving the level of nuclear energy deployment envisaged in the BLUE Map scenario will still present significant challenges. However, most of the potential barriers to the rapid expansion of nuclear energy in the short to medium term are policy-related, industrial or financial, rather than technological.

One factor that sets nuclear apart from most other low-carbon energy technologies is that, in some countries at least, adopting or expanding a nuclear programme will be the subject of considerably greater public and political opposition. In the 1980s, concerns about, in particular, nuclear safety (heightened by the Three Mile Island and Chernobyl accidents) and radioactive waste led to the emergence of strong anti-nuclear movements in many OECD countries, including some with large nuclear programmes. As a result, several European countries and US states introduced formal moratoria on nuclear expansion and, in a

Figure 1. Annual power sector CO₂ emission reductions in the BLUE Map scenario in 2050 compared to the Baseline scenario, by technology area

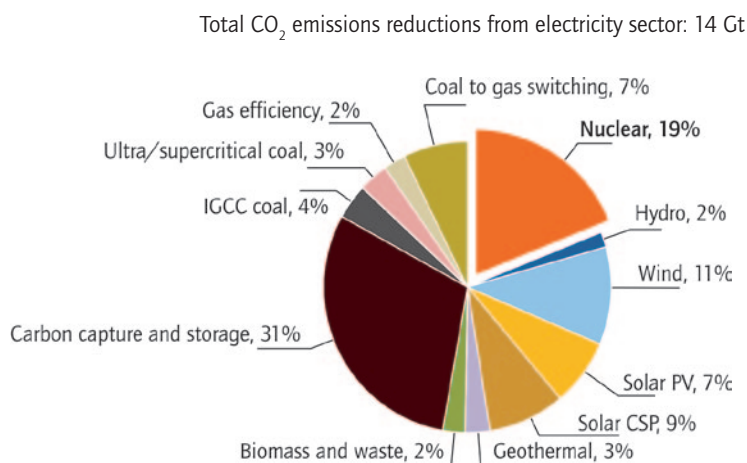

Source: IEA, 2010.

Note: The figures given represent only the additional contribution to emissions reductions in the BLUE Map scenario; the Baseline scenario already assumes a significant nuclear expansion.

KEY POINT: Nuclear power makes a major contribution to reducing CO₂ emissions in the BLUE Map scenario.

few cases, sought to phase out existing nuclear capacity. Others decided not to proceed with planned nuclear programmes.

Although opposition in some countries to nuclear expansion has subsided in recent years, a few countries remain firmly against. This could limit the scope for expanding global nuclear capacity. Although most large energy consuming nations are now at least considering a nuclear programme, successfully implementing solutions for radioactive waste disposal, together with continued safe operation of nuclear power plants and fuel cycle facilities, will be vital to achieving the scale of nuclear expansion envisaged in the BLUE Map scenario.

For a country to embark on a nuclear power programme, or continue to develop an existing programme, clear and sustained policy support from the national government is a prerequisite. This is likely to require broad societal support for nuclear energy's role in the overall national strategy for achieving energy supply and environmental objectives. Beyond providing policy support, governments wishing to see nuclear development also need to put in place the essential legal, regulatory and institutional framework. This includes an effective system of licensing and regulatory oversight for nuclear facilities, and a strategy for radioactive waste management.

Other challenges to a major expansion of nuclear capacity include:

- Financing the large investments needed, especially where nuclear construction is to be led by the private sector.
- Developing the necessary industrial capacities and skilled human resources to support sustained growth in nuclear capacity.
- Expanding the supply of nuclear fuel in line with increased nuclear generating capacity, and ensuring all users of nuclear energy have access to reliable supplies of fuel.
- Implementing plans for building and operating geological repositories for the disposal of spent fuel and high-level radioactive wastes.
- Maintaining and strengthening where necessary the safeguards and security for sensitive nuclear materials and technologies, to avoid their misuse for non-peaceful purposes.

Overcoming these challenges on a wide scale will clearly take some years. For this reason, it can be expected that nuclear expansion up to 2020 will be relatively modest, setting the scene for a potentially more rapid expansion in the following decades.

In the longer term, further development of the technology will be required if nuclear energy is to meet its full potential. A new generation of nuclear power plant designs with advanced fuel cycles, now under development, could offer important advances in economics, sustainability, proliferation resistance, safety and reliability. They could make full use of the ability to recycle nuclear fuel, greatly increasing the energy potential of uranium resources. On present plans, such plants could start to contribute to nuclear generating capacity before 2050.

This roadmap considers exclusively the use of energy based on nuclear fission, the splitting of the nuclei of heavy elements such as uranium. A very different process, nuclear fusion, could also potentially be used as an energy source in the long term. In fusion, light nuclei (isotopes of hydrogen) are fused together, releasing energy. Achieving this requires extremely high temperatures and pressures, presenting formidable engineering challenges. It will require technology totally different from that used for nuclear fission.

The current focus of fusion research is the International Thermonuclear Experimental Reactor (ITER), now under construction in France. Expected to start operation in 2018, ITER will aim to demonstrate the feasibility of fusion energy over its 20-year operating life. If all goes well, a follow-up demonstration of a practical fusion-based energy generating system could follow in the 2030s or 2040s. However, commercial use of such technology is not expected until after 2050, and could still be many decades away.

Purpose of the roadmap

This roadmap examines each of the challenges to greater nuclear deployment and what needs to be done by governments and other stakeholders to address them. It presents a vision of how the major expansion of nuclear energy envisaged by the BLUE Map scenario over the next four decades could be achieved as part of a strategy to significantly reduce energy-related CO₂ emissions.

The process of developing this roadmap included two workshops jointly organised by the IEA and NEA, involving a range of experts from the nuclear and electricity industries, governments and international organisations. The first was held in London in September 2009, in co-operation with the World Nuclear Association (a nuclear industry organisation), and the second in Paris in October 2009 at the IEA.

Many countries are presently considering building new nuclear generating capacity during the next decade and beyond. The next few years will show whether they will in fact take these plans forward in a timely manner. Hence, this roadmap is designed to be a living document that can be updated regularly to address new developments.

The status of nuclear energy today

The generation of electricity using nuclear energy was first demonstrated in the 1950s, and the first commercial nuclear power plants entered operation in the early 1960s. Nuclear capacity grew rapidly in the 1970s and 1980s as countries sought to reduce dependence on fossil fuels (Figure 2), especially after the oil crises of the 1970s. However, with the exception of Japan and Korea, growth stagnated in the 1990s. Reasons for this included increased concerns about safety following the Three Mile Island and Chernobyl accidents, delays and higher than expected construction costs at some nuclear plants, and a return to lower fossil fuel prices.

At the end of 2009, there were 436 power reactors in operation in 30 countries, totalling 370 GW of installed capacity. The share of nuclear energy in countries with operating reactors ranges from less than 2% to more than 75% (Figure 3). Overall, nuclear power provides around 14% of global electricity, and 21% of electricity in OECD countries (Figure 4). Nuclear and hydropower are the only low-carbon sources presently providing significant amounts of energy. Existing nuclear generation avoids annual CO₂ emissions of about 2.9 billion tonnes compared to coal-fired generation, or about 24% of annual power sector emissions.

Although nuclear power plants produce virtually no CO₂ directly, nuclear cannot be said to be completely carbon-free. Some indirect emissions, mainly from fossil fuel use in the fuel cycle, can be attributed to nuclear electricity. However, these emissions are at least an order of magnitude below the direct emissions from burning fossil fuels, and are similar to those attributable to renewable energy sources.

Managing the existing nuclear fleet

This roadmap recommends that:

- While continuing to operate existing nuclear plants safely and efficiently, utilities should invest in upgrading and preparing for extended lifetimes where feasible.

Building a nuclear power plant requires a large capital investment, but once in operation it has relatively low and predictable fuel, operating and maintenance costs. This means that nuclear plants have low marginal costs of production, but take many years to recoup their capital costs. Hence, maximising their lifetime generation makes good

Figure 2. World nuclear generating capacity, 1960 to 2009

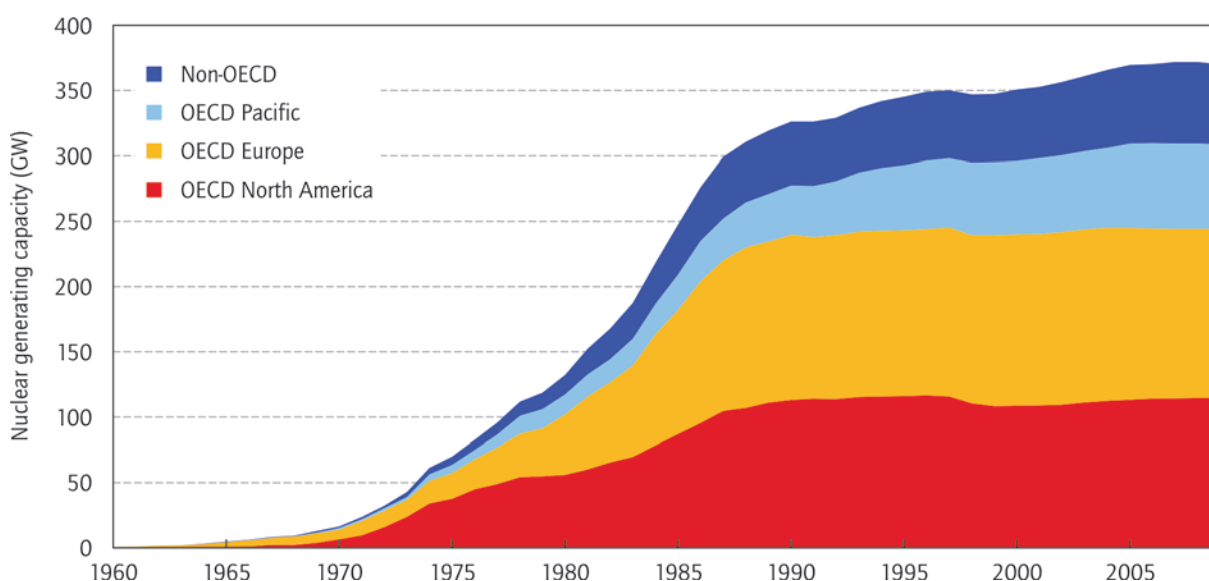

Source: IAEA PRIS.

KEY POINT: Nuclear capacity grew rapidly in the 1970s and 1980s, but much more slowly after 1990.

Figure 3. Share of nuclear power in total electricity, 2009 (%)

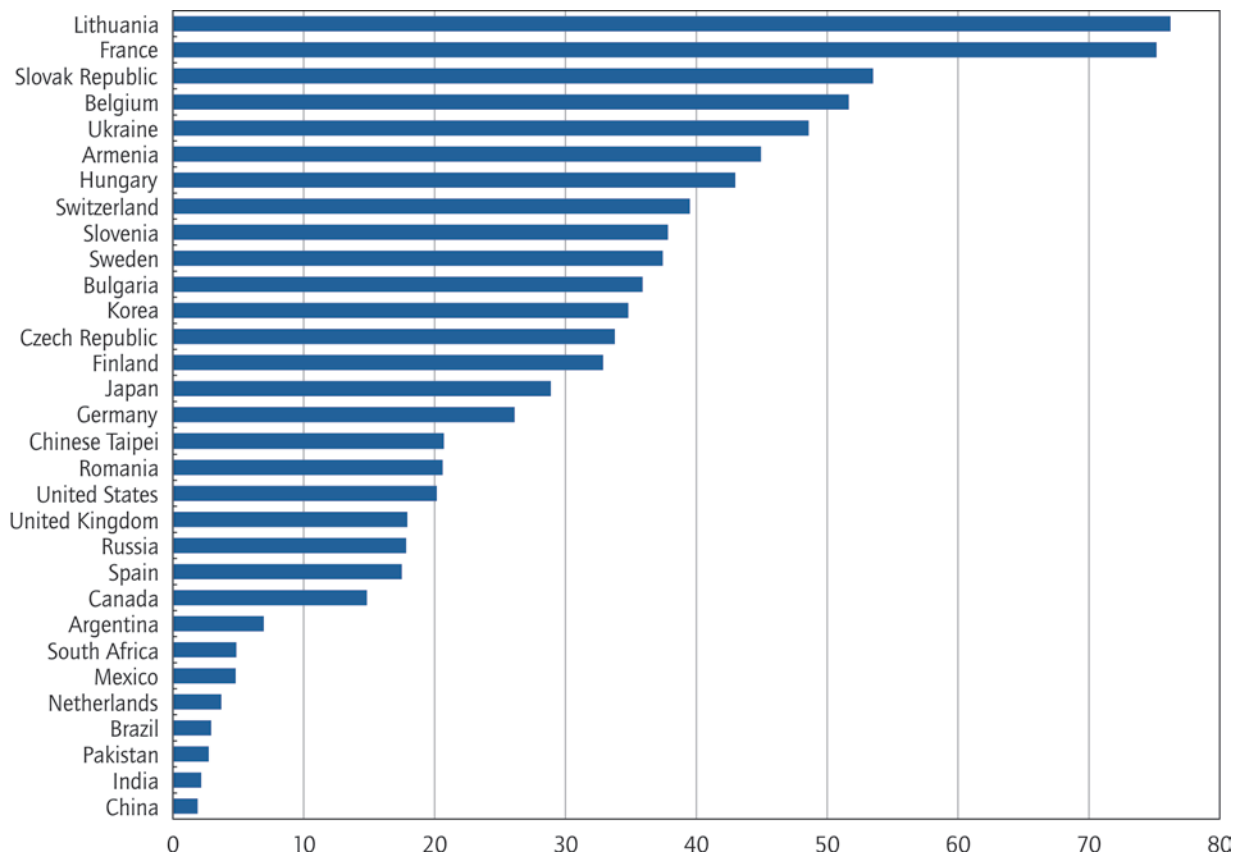

Source: IAEA PRIS.

Note: Lithuania closed its only nuclear plant at the end of 2009 and now has no nuclear capacity.

KEY POINT: Fifteen countries obtain more than a quarter of their electricity from nuclear power.

economic sense, even where this involves further investment to update systems and components. It will also help reduce cumulative CO₂ emissions from the electricity sector.

A prerequisite for maximising the potential of existing reactors, as well as for future nuclear expansion, is continued safe operation. In addition to strong and independent regulators, it has been shown that safe operation (as well as good operating performance) depends on developing and maintaining a “safety culture” among all those involved in operating and maintaining nuclear plants. This is an important management responsibility of the companies and organisations engaged in nuclear activities.

As the owners of existing nuclear plants seek to maximise their output, three main trends can be observed. Firstly, operating performance has

generally improved since the 1990s, with fewer unplanned shutdowns and increased annual electricity production. Secondly, many nuclear plants have had their maximum generating capacity increased, often as a result of investment in upgraded equipment. Thirdly, many nuclear plants are now expected to operate for up to 20 years longer than originally planned.

The global average performance of nuclear power plants in terms of energy availability factor (the percentage of the time the plant was available to supply at full power) increased steadily through the 1990s (Figure 5), and availability factors above 90% are being achieved regularly in several countries. However, the global upward trend has stalled in recent years, in part due to extended shutdowns of several reactors in a few countries.

Figure 4. Electricity generation by source, worldwide and OECD, 2007

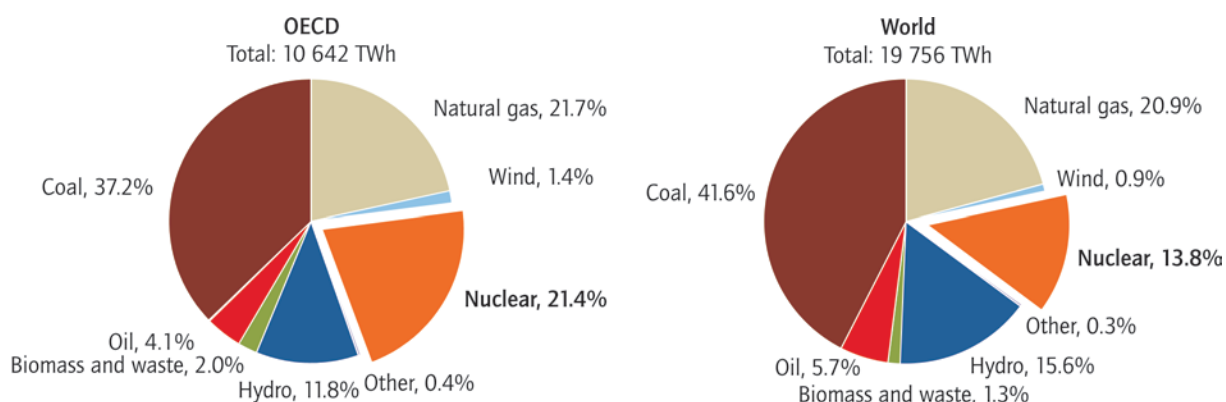

Source: IEA, 2009.

Note: "Other" includes geothermal, solar, tidal and wave power.

KEY POINT: Nuclear and hydropower are the main low-carbon energy sources at present.

Another way to increase output is through a power uprate, which means modifying the plant in order to produce more electricity. Some uprates just involve using improved instrumentation, while others require significant investment in upgraded equipment, particularly higher efficiency turbines. Many reactors in the United States and Europe have had or are expected to have their licensed output uprated, in some cases by as much as 20%.

The great majority of nuclear plants in operation today are already more than 20 years old, with many older than 30 years. Most were conceived for operating lifetimes of 40 years. However, most components and systems can be replaced as they wear out or when it becomes attractive to install upgraded equipment. There are a few major components that cannot be replaced, including the reactor pressure vessel, but in most cases these are

Figure 5. Average worldwide energy availability factors for nuclear power plants

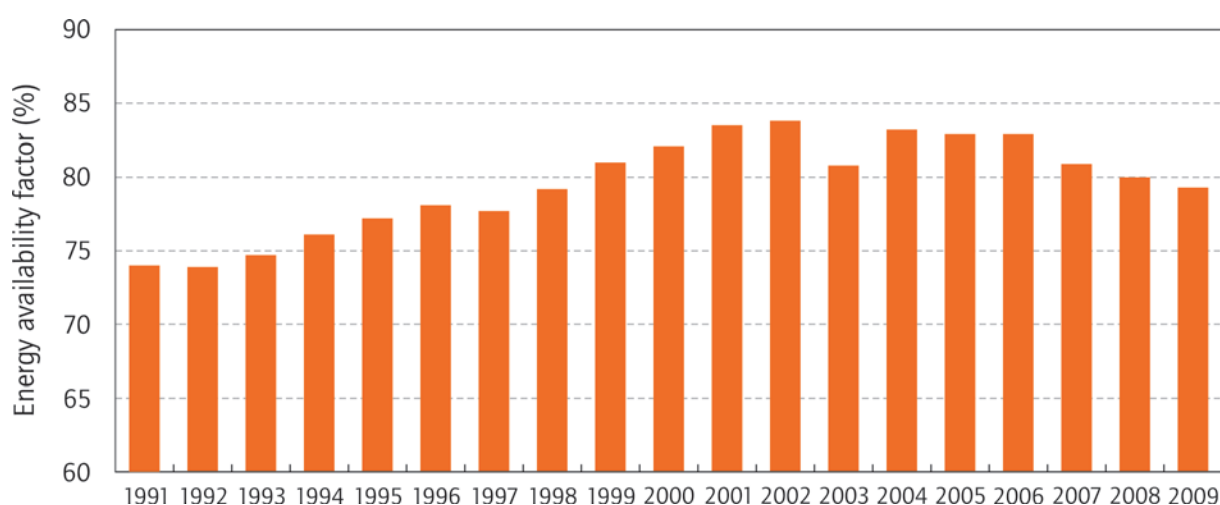

Source: IAEA PRIS.

KEY POINT: The average operating performance of nuclear power plants improved markedly in the 1990s and early 2000s, but has fallen in the last few years.

expected to be suitable for extended operation. Hence, for many plants an operating lifetime of 50 to 60 years is now considered realistic. Some consideration is already being given to the potential for even longer lifetimes of up to 80 years, but the feasibility of this remains uncertain.

Nuclear regulators in countries with older plants have set out technical requirements for licensing plants for such extended operation. For example, in the United States, the Nuclear Regulatory Commission has granted licences for 60 years total operation to more than half the existing fleet, with others under review. Many reactor owners have implemented upgrading programmes with the aim of improving current operating performance and uprating power output, as well as preparing the plant for an extended operating life.

Nuclear energy technology for near-term deployment

This roadmap recommends that:

- The nuclear industry should fully establish the latest nuclear power plant designs by constructing reference plants in a few countries around the world, to refine the basic design and any regional variants, and build up global supply chains and capacities.
- The nuclear industry should go on to demonstrate that these new designs can be reliably built on time and within expected costs, making continuous efforts to reduce construction times and control costs by using standardised designs to the extent possible, refining the construction process and further strengthening supply chains.

The low level of orders for nuclear power plants since the 1980s has resulted in the contraction of the nuclear industry in Europe and North America, and in a series of consolidations over the last 15 years. Hence, the overall industrial capacity and skilled human resources available for nuclear construction have shrunk considerably. This has led to the emergence of just a handful of

companies worldwide able to design and build nuclear plants, most of them with multinational interests and assets.

Beyond the few nuclear plants ordered since 1990, these nuclear industry companies have remained active in the business of fuelling, maintaining and upgrading existing units. They have also continued to develop their designs for new nuclear power plants, building on the experience gained in building and maintaining existing reactors. Most appear well-prepared to take advantage of orders for new plants.

In addition, Korea has developed a strong nuclear industry which is now taking the first steps beyond its home market. China and India also have significant nuclear industries, although these are expected to remain focused on their domestic markets, at least in the near term. Although subject to significant market distortions, the supply of nuclear power plants is thus becoming a competitive business on a global scale.

Each of the latest designs available from the main suppliers offers a comparable level of technology, sometimes known collectively as Generation III or III+ (while most existing reactors are considered Generation II). The aim has been to “design out” many of the issues encountered in the construction and operation of existing plants. Design simplification and the use of advanced construction techniques (such as modular construction) are important themes, with the goal of reducing construction times and costs. The designs offer improved performance and reliability, greater fuel efficiency, enhanced safety systems, and produce less radioactive waste. The plants are designed from the outset to operate for up to 60 years with availability factors exceeding 90%.

The intention of each supplier is to offer, as far as possible, one or more standardised designs worldwide, to reduce the risk of construction delays caused by design changes. Standardisation will also offer benefits during operation, from exchange of information and experience between operators and easier movement of personnel and contractors between similar plants.

The leading designs presently being offered by the major nuclear power plant suppliers worldwide, which are expected to provide the great majority of new nuclear capacity at least until 2020, are described in Box 1.

Box 1. The main designs for nuclear power plants for deployment by 2020

The **AP-1000** is the flagship design from Westinghouse. Although majority owned by Toshiba of Japan, Westinghouse is headquartered in the United States. The AP-1000 is an advanced pressurised water reactor (PWR) with a capacity of about 1 200 MW, the first three examples of which are at an early stage of construction in China. The design has also been selected for the largest number of potential new US plants, and is being offered in the United Kingdom and other markets.

The **EPR** is the main offering from AREVA, the main European nuclear industry group which is majority owned by the French state. Also an advanced PWR, it will have an output of 1 600 to 1 700 MW. The first units are now under construction in Finland and France. Two further EPRs are beginning construction in China, with a further order due shortly in France. Up to four orders are expected in the United Kingdom, while others are under consideration in the United States.

The **ABWR** (Advanced Boiling Water Reactor) is the only one of the recent designs already in operation, with four units in Japan. Two further ABWRs are under construction in Chinese Taipei. These units have outputs in the 1 300 MW range, but up to 1 600 MW versions are offered. The basic design was developed jointly by General Electric (GE) of the United States and Toshiba and Hitachi of Japan. GE and Hitachi subsequently merged their nuclear businesses.

The **ESBWR**, a further development of the ABWR concept, is the latest offering from GE-Hitachi. Its output will be in the region of 1 600 MW. No orders have been secured to date, but the design has been selected for some potential new US plants.

The **APWR** (Advanced PWR) has been developed for the Japanese market by Mitsubishi Heavy Industries (MHI), with two units expected to begin construction in the near future. Output will be around 1 500 MW per unit. MHI is also offering a version of the APWR in the US market, and has been selected for one potential project.

The **VVER-1200** (also known as AES-2006) is the most advanced version of the VVER series of PWR designs produced by the Russian nuclear industry, now organised under state-owned nuclear holding group Rosatom. Four VVER-1200 units are under construction in Russia, each with a net power output of about 1 100 MW. Additional designs are also offered in other markets, including the VVER-1000, which has been exported to several countries, including China and India.

The **ACR** (Advanced CANDU Reactor) is the newest design from Atomic Energy of Canada Ltd. (AECL), owned by the Canadian government. Most CANDUs use heavy water to moderate (or slow) neutrons, making it possible to use natural uranium fuel. However, the 1 200 MW ACR will use enriched fuel, the first CANDU design to do so. AECL also offers the Enhanced CANDU 6, a 700 MW unit using natural uranium. No orders for either design have been placed so far.

The **APR-1400** is the latest Korean PWR design, with two 1 340 MW units under construction and several more planned. It is based on original technology now owned by Westinghouse. This has been further developed by Korean industry in a series of more advanced designs. The licensing agreement still limits its availability in export markets, but in late 2009 a Korean-led consortium (with Westinghouse participation) won a contract to build four APR-1400s in the United Arab Emirates.

The **CPR-1000** is currently the main design being built in China, with 16 units under construction. This 1 000 MW design is an updated version of a 1980s AREVA Generation II design, the technology for which was transferred to China. A 2007 agreement with Westinghouse for the construction of four AP-1000s includes the transfer of this technology to China; the first three units are now under construction. This is expected to form the basis of the next generation of Chinese nuclear plants.

India's **PHWR** (Pressurised Heavy Water Reactor) designs are based on an early CANDU design exported from Canada in the 1960s. The latest units have a capacity of 540 MW, and 700 MW units are planned. Although further developed since the original design, these are less advanced than Generation III designs. In addition to building PHWRs, India has imported two VVERs from Russia, and is expected to place further orders for nuclear imports in the near future.

Status of the nuclear fuel cycle

Uranium, the raw material for nuclear fuel, is presently mined in significant quantities in 14 countries (Table 1). Since the early 1990s, uranium production has been less than two-thirds of annual reactor requirements (presently about 68 000 tonnes). The balance has been mainly supplied from stockpiles of uranium built up since the 1950s. These were partly commercial inventories and partly government-held strategic inventories (including material from dismantled nuclear warheads). To a lesser extent, the recycling of nuclear fuel and the recovery of useable uranium from enrichment tailings (discussed below) have also contributed.

Although significant uranium inventories of various types still remain, uranium production is expected to increase over the next few years to cover a larger part of demand. Market prices for uranium, depressed throughout the 1990s, have been at higher levels in the last few years. This has not resulted in a rapid increase in production, but it has spurred plans to expand capacity at existing and new mines. Major expansion is planned in Australia, Canada, Kazakhstan, Namibia, Niger, Russia and South Africa. Uranium production capacity, presently around 55 000 tonnes per year, could rise to about 100 000 tonnes by 2015. However, much of this investment will depend on market conditions over the next few years.

Nuclear fuel itself is a manufactured product (see Box 2 for more details). At current prices, uranium is only about half the cost of nuclear fuel, with enrichment accounting for about 40%. While uranium hexafluoride (UF₆) conversion and enrichment are generic processes, each individual nuclear plant or series of very similar plants has a unique fuel design. The detailed design and composition of the fuel, and the quality of its structural components, can have a significant impact on the overall reliability and performance of the plant. The improvement in nuclear plant performance since 1990 has partly resulted from innovation in fuel design, reducing the incidence of fuel leakage and increasing the energy extracted from each fuel assembly.

Most nuclear fuel cycle facilities are located in a small number of OECD countries and Russia, although several other countries have smaller capacities (Table 2). These facilities have adequate capacity to support the existing fleet of reactors

as well as those entering operation in the next few years. However, some existing facilities are being replaced or expanded, or will be over the next few years. In particular, new enrichment capacity based on more efficient centrifuge technology is under construction in the United States and France to replace older diffusion plants (which will be retired in the next few years). Meanwhile, other enrichment suppliers (which already operate centrifuge plants) are gradually expanding capacity in line with demand. UF₆ conversion capacity in France is also being updated.

The bulk of the natural uranium processed in enrichment plants (around 85% by weight) is left in the tailings (the waste stream). In recent years, significant amounts of this depleted uranium have been further processed to create additional enriched uranium, by extracting some of the residual U-235 (typically about 0.3%) left after its initial enrichment. However, as enrichment supply and demand become more balanced, uranium supply from this source is expected to fall.

It is possible to recycle spent nuclear fuel and use the uranium and plutonium it contains to prepare further nuclear fuel (as explained in Box 2). Although taking full advantage of recycling will require the use of fast reactors (discussed later

Table 1. Uranium production by country, 2008

Country	Uranium production (tonnes)
Australia	8 430
Brazil	330
Canada	9 000
China	769
Czech Republic	263
India	271
Kazakhstan	8 521
Namibia	4 366
Niger	3 032
Russia	3 521
South Africa	655
Ukraine	800
United States	1 430
Uzbekistan	2 338
Others	127
Total	43 853

Source: WNA, 2009.

in this roadmap), some recycling of spent fuel already takes place with existing reactors. Large-scale reprocessing plants to extract uranium and plutonium from spent fuel are in operation in France, Russia and the United Kingdom, with a further large plant under construction in Japan.

Fuel made using recycled materials is technically suitable for use in many existing reactors, where appropriate fuel handling facilities exist. In practice, the use of such fuel is limited by licensing requirements, fuel cycle economics and the capacity of the necessary dedicated fuel cycle facilities. As a result, some stockpiles of reprocessed uranium and plutonium have built up. Recycling currently provides 4 to 5% of nuclear fuel supply, principally in Western Europe, Japan and Russia. This is expected to increase gradually over the next few years, partly as higher uranium prices make it more economically attractive. In principle, recycling all spent fuel in this way could reduce uranium consumption by around 30%, although that would require a large increase in reprocessing and other dedicated fuel cycle capacities.

The management of radioactive waste

Various types of radioactive waste are produced in the nuclear fuel cycle, ranging from objects slightly contaminated by contact with nuclear materials, to highly active spent nuclear fuel and reprocessing wastes. They can be classified as low-, intermediate- and high-level wastes, with intermediate-level also divided into short- and long-lived types.

Technology for the treatment, storage and disposal of low-level and short-lived intermediate-level wastes is well developed and almost all countries with a major nuclear programme operate disposal facilities for such wastes. While these represent the largest volumes of radioactive waste, the great majority of the radioactivity is contained in the relatively small volumes of spent nuclear fuel and, for countries that have recycled nuclear fuel, high-level waste from reprocessing.

Table 2. Annual capacities of major commercial nuclear fuel cycle facilities for light water reactors (LWRs), by country

Country	UF ₆ conversion (tonnes U)	Uranium enrichment (tSWU)	LWR fuel fabrication (tHM)
Belgium	–	–	700
Brazil	–	–	280
Canada	12 500	–	–
China	3 000	1 300	450
France	14 500	10 800	1 400
Germany	–	4 000	650
India	–	–	48
Japan	–	150	1 724
Korea	–	–	600
Netherlands	–	4 000	–
Russia	25 000	20 250	1 600
Spain	–	–	300
Sweden	–	–	600
United Kingdom	6 000	3 000	860
United States	15 000	11 300	3 650

Source: WNA, 2009.

Notes: Some capacities are approximate, and effective operating capacities may be lower. Several countries have small or pilot facilities in operation, not included here. Fuel cycle facilities for heavy water reactors (UO₂ conversion and fuel fabrication) are also not included. Enrichment capacity is given in thousands of separative work units (tSWU), fuel fabrication in tonnes of heavy metal (tHM).

Spent fuel and high-level waste initially contain highly radioactive but short-lived fission products that generate heat. They must be stored under controlled conditions for up to several decades before disposal, while these fission products decay. Initial storage of spent fuel is in a water pool at the reactor site. In some countries it is transferred to a central storage facility after several years. As it cools, it can also be transferred to dry storage in shielded metal casks. Liquid high-level waste from reprocessing is vitrified in metal containers for interim storage.

It has been demonstrated in several countries that such storage can continue safely and at low cost for extended periods of time. However, demonstrating the feasibility of permanent disposal of such wastes, at least in a few countries, will be important for building public confidence in nuclear energy. The main challenge for the future is thus to develop and implement plans for the disposal of spent fuel, high-level wastes and long-lived intermediate-level wastes in deep geological repositories. This issue will be further discussed later in this roadmap.

Nuclear energy deployment to 2050: actions and milestones

Nuclear capacity growth in the BLUE Map scenario

The IEA's *Energy Technology Perspectives 2010* BLUE Map scenario (IEA, 2010) projects an installed nuclear capacity of almost 1 200 GW in 2050, compared to 370 GW at the end of 2009, making nuclear a major contributor to cutting energy-related CO₂ emissions by 50%. This nuclear capacity would provide 9 600 TWh of electricity annually by that date, or around 24% of the electricity produced worldwide. In BLUE Map, by 2050 nuclear power becomes the single largest source of electricity, surpassing coal, natural gas, hydro, wind and solar (Figure 6).

Although reaching 1 200 GW of nuclear capacity in 2050 is an ambitious goal, multiplying the installed nuclear capacity by well over three times during a period of 40 years is certainly achievable from technical and industrial perspectives. Assuming that by 2050 all reactors in operation today will have been decommissioned, some 30 units of 1 GW each would need to enter operation on average each year between 2010 and 2050. Similar rates of construction were achieved (albeit briefly) in the 1970s and 1980s, even though fewer countries were implementing nuclear programmes and industrial capabilities were less developed at that time.

In reality, the required construction rate to achieve the BLUE Map scenario is likely to be lower. As noted earlier, many existing units are licensed for up to 60 years of operation and a trend towards extended operating lifetimes can be observed worldwide. Hence, up to 60 GW of existing capacity could remain in operation by 2050. Furthermore, many current reactor designs have a capacity larger than 1 GW, typically in the range 1.2 to 1.7 GW, and these are likely to be chosen in countries with high electricity demand and grids suitable for large units. Taking these factors into account implies that an average of about 20 large nuclear units per year would need to be constructed over the 40-year period. This means that the rate of construction starts of new nuclear plants will need to roughly double from its present level by 2020, and continue to increase more slowly after that date.

The global growth in nuclear capacity in the BLUE Map scenario includes large regional variations. By far the largest expansion is projected in China, up from less than 3% of global capacity today to about 27% in 2050. India is also expected to significantly expand its capacity, from less than 2% to about 11% in 2050. Although nuclear capacity is expected to grow in OECD countries, especially the North America and Pacific regions, in BLUE Map their share of global nuclear capacity will fall from over 80% today to less than 50% in 2050.

Figure 6. Global electricity production by source in 2007, and in 2050 in ETP 2010 Baseline, BLUE Map and BLUE High Nuclear scenarios

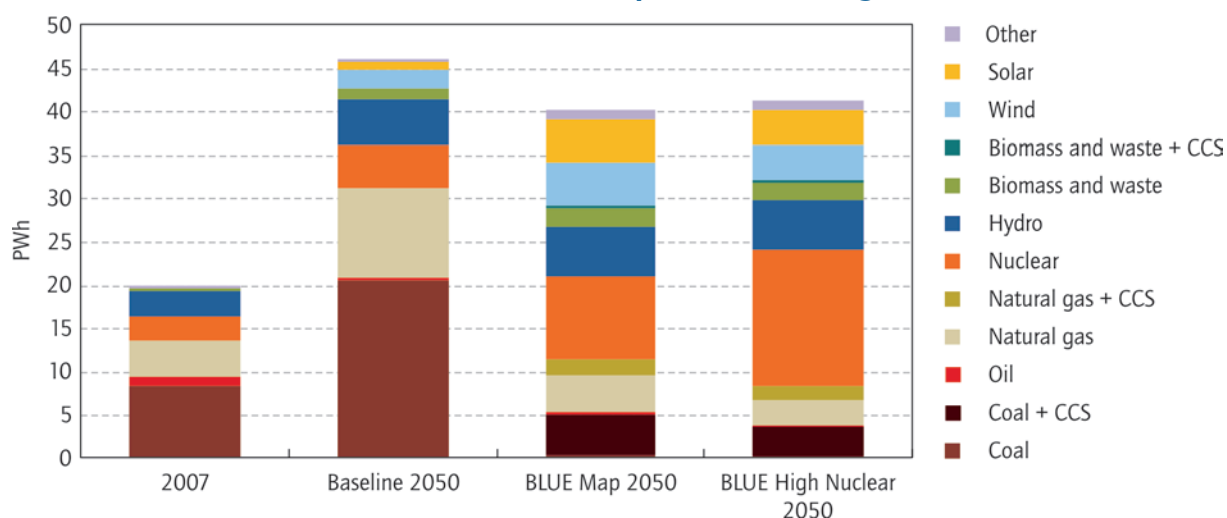

Source: IEA, 2010.

Note: CCS is carbon capture and storage. "Other" includes geothermal, tidal and wave power.

KEY POINT: In the BLUE Map scenario, nuclear power is the largest single source of electricity in 2050.

The BLUE High Nuclear scenario has total nuclear capacity reaching 2 000 GW in 2050, supplying almost 16 000 TWh of electricity, or 38% of the world total (Figure 6). The NEA High scenario (NEA, 2008) projects nuclear capacity of 1 400 GW by that date. Clearly, these scenarios would require higher rates of nuclear construction, especially in the later decades, as well as greater increases in nuclear fuel supply. Such scenarios are not considered in detail in this roadmap. However, any large scale expansion of nuclear energy will require the same initial steps by 2020 to establish a platform for more rapid expansion in later decades. The extent to which nuclear capacity expands in the longer term will largely depend on its competitiveness in comparison with other low-carbon energy sources.

The outlook for nuclear expansion to 2020

At the end of 2009, 55 new power reactors were officially under construction in 14 countries (Table 3). Of these, China had the largest programme, with 20 units under construction. Russia also had several large units under construction. Among OECD countries, Korea had

the largest expansion underway with 6 units, but Finland, France, Japan and the Slovak Republic were each building one or two new units. In the United States, a long-stalled nuclear project has been reactivated. In total, these new units can be expected to add around 50 GW of new capacity to existing capacity of 370 GW (although a few gigawatts of older capacity are also expected to close over the next few years).

Looking towards 2020, since the entire process of planning, licensing and building new nuclear power plants takes typically at least 7 to 10 years, most nuclear capacity that will be in operation by that date will already be in the planning and licensing processes. Forecasts for this period can thus be based on an examination of existing plans for new nuclear construction worldwide.

Some countries with active nuclear construction are expected to continue their nuclear expansion with further construction starts in the next few years. In particular, major expansion of nuclear capacity is planned in China, India and Russia. Several other countries with existing nuclear plants are now actively considering new nuclear capacity, with final decisions expected in the next few years. These include Canada, the Czech Republic, Lithuania, Romania, the United Kingdom and the United States. Of these, the United States could be the

Table 3. Nuclear power plants under construction, as at end 2009

<i>Location</i>	<i>No. of units</i>	<i>Net capacity (MW)</i>
Argentina	1	692
Bulgaria	2	1 906
China	20	19 920
Finland	1	1 600
France	1	1 600
India	5	2 708
Iran	1	915
Japan	1	1 325
Korea	6	6 520
Pakistan	1	300
Russia	9	6 996
Slovak Republic	2	782
Chinese Taipei	2	2 600
Ukraine	2	1 900
United States	1	1 165
Total	55	50 929

Source: IAEA PRIS.

most significant; more than 30 new nuclear units are under consideration, with licence applications having been submitted for 22 of these by the end of 2009. Countries with no existing nuclear plants that are considering installing nuclear capacity by 2020 include Italy, Poland, Turkey and the United Arab Emirates. The latter announced an order for four large units in late 2009.

Taking into account current plans and capabilities of the countries building and planning to build new nuclear capacity in the next few years, together with likely closures of older plants, scenarios prepared by several organisations, including the IEA and NEA, show nuclear capacity reaching between 475 and 500 GW by 2020. The higher end of this range takes into account China's recent acceleration of its nuclear programme.

An expansion to 500 GW will require that, in addition to units already being built, construction of approximately an additional 90 GW (allowing for closures of a few older units) starts by about 2016, or some 12 to 13 GW per year. In 2009, 11 large nuclear projects with a total capacity of just over 12 GW entered construction. Of these, nine were in China, with one each in Korea and Russia. There were ten construction starts (10.5 GW) in 2008, of which six were in China and two each in Korea and Russia. These two years had the highest numbers of construction starts since 1985, even though only these three countries were involved. Although China in particular is expected to play a leading role in future nuclear expansion, additional countries will need to commence new nuclear construction in the next few years if the pace of expansion is to be maintained.

With relatively few nuclear plants having been built in recent decades, the available industrial capacity for nuclear construction is presently limited in most countries. As noted above, consolidation in the industry has led to the emergence of a small number of multinational suppliers with global supply chains. Although most have already begun to expand their capacities in response to actual and anticipated demand, considerably more capacity will be needed. Nuclear suppliers clearly already have the industrial and human capacities to be involved in building a handful of nuclear plants; the challenge will be to expand these capacities and supply chains over the next few years to meet a sustained higher level of demand.

Preparing for more rapid deployment after 2020

This roadmap recommends that:

- The nuclear industry should invest in building up industrial capacities and skilled human resources worldwide to increase global capability to build nuclear power plants, broadening supply chains while maintaining the necessary high quality and safety standards.
- For countries launching or re-activating nuclear programmes, governments should ensure that suitably qualified and skilled human resources are available to meet the anticipated needs of the nuclear programme, including in government, electricity utilities, industry, and regulatory agencies.

Doubling the rate of nuclear construction by 2020 to reach the levels of deployment envisaged in the BLUE Map scenario will require large investments over the next few years in additional industrial capacities and in educating and training the necessary skilled workforce.

Historically, nuclear plant construction has reached considerably higher levels than at present. During the 1970s, construction starts peaked at over 30 units per year, with an average of over 25 per year during the decade (Figure 7). This was a large increase over the preceding decade. Although these units were smaller than current designs, the technology was also less well developed at that time. In addition, relatively few countries were involved in that earlier rapid nuclear expansion, and overall global industrial capacity has increased greatly since the 1970s. Much future expansion of electricity supply, and hence of nuclear capacity, will take place in large, rapidly industrialising non-OECD countries (notably China and India).

However, investment in increased capacities, if it is to be made on a commercial basis, will only take place once it is clear that sufficient long-term demand exists. Capacities can thus be expected to build up gradually over a period of some years in response to rising demand. Hence, a rising level

of orders for new nuclear plants over the next few years will be needed not only to achieve a nuclear capacity of around 500 GW by 2020, but also to allow for the expansion of industrial and human capacities that will be required for more rapid growth after 2020.

Nuclear power plants are highly complex construction projects. The nuclear supplier, as the designer and technology holder, will supply only the plant's nuclear systems. A wide range of specialist sub-contractors and suppliers is involved in providing and installing the remaining systems and components. Large parts of the plant, including concrete constructions and turbine generators, are similar to non-nuclear plants and are generally provided by heavy construction and engineering firms with appropriate expertise. The "architect-engineering" function, encompassing general engineering, scheduling and cost management, and co-ordination between contractors and suppliers, is also very important in a nuclear project.

Hence, complex global supply chains need to be developed and managed to ensure the successful completion of nuclear projects. As more orders are placed for new nuclear plants, supply chains will become broader as suppliers seek to expand their capacity to serve markets around the world. In many cases, this will mean involving local and regional construction and engineering firms as nuclear energy expands into new markets.

The production of most reactor components can be increased within, at most, a few years in response to market demand. The longest lead time for capacity additions is expected to be for large steel forgings, which are used in greater numbers in the latest nuclear plant designs. While there is adequate capacity to produce many of these forgings, the very largest forgings for some designs can presently be produced for many markets in only one facility worldwide (in Japan). It can take five years or more to expand such heavy forgings capacity, as it requires a very large investment and only a few companies have the necessary expertise. Plans to expand very large forgings capacity are now being developed by established suppliers in Korea and the United Kingdom, although going ahead with these is likely to depend on receiving firm customer commitments.

The nuclear sector as a whole, including the nuclear industry, utilities and regulators, requires highly qualified and skilled human resources. Expanding nuclear energy will require a larger pool of highly trained scientists and engineers, and skilled crafts-people, all of which are potentially in short supply. Many nuclear industry companies have in recent years expanded their recruitment and training programmes, and there is also a role for governments and universities in ensuring the availability of appropriate courses and training.

The long lifetimes of nuclear power plants, extending over several human generations, make knowledge management an important

Figure 7. Number of nuclear power plant construction starts each year, 1955 to 2009

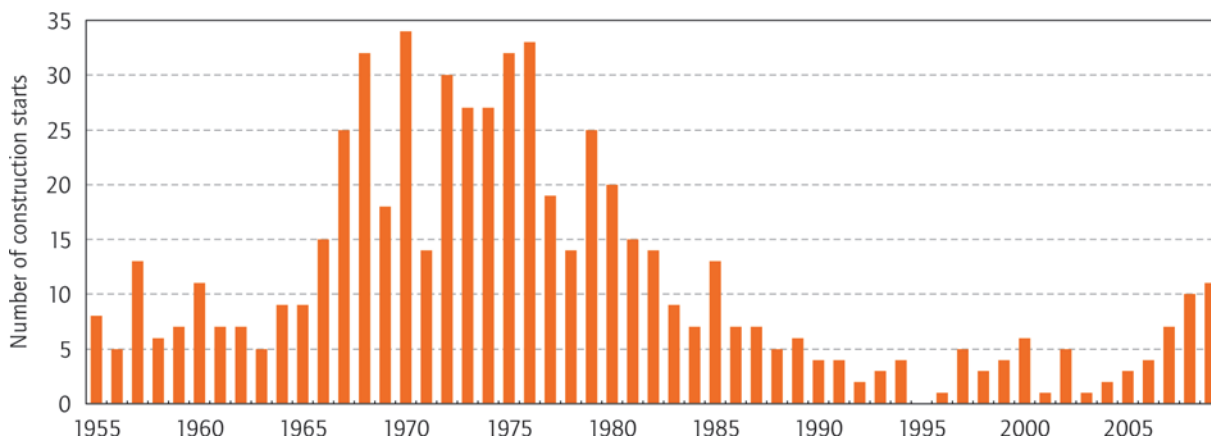

Source: IAEA PRIS.

KEY POINT: Nuclear power plant construction starts peaked in the 1970s after growing rapidly in the late 1960s.

consideration. Preservation of knowledge is important for achieving safe and effective lifetime extension of existing units, as well as for designing and building new plants that benefit from experience. Important know-how may be lost as the scientists and engineers who implemented the ambitious nuclear programmes of the 1970s and 1980s reach retirement age. Hence, knowledge management and transmission of know-how to younger specialists will need to be high priorities in the nuclear sector.

Nuclear fuel cycle requirements

This roadmap recommends that:

- The nuclear industry should expand uranium production and the capacity of nuclear fuel cycle facilities in line with the growth of nuclear generating capacity, including the deployment of more efficient advanced technologies where available.

When considering increased reliance on nuclear energy, it is important to assess the availability of uranium and fuel cycle capacities, in order to ensure long-term security of fuel supply. Despite limited exploration over the last 20 years, the ratio of known uranium resources to present consumption is comparable to other mineral energy resources, representing about 100 years' supply. Additional resources that are expected (on the basis of existing geological information) to be

discovered could increase this to around 300 years' supply. Inclusion of estimated "unconventional" resources, notably uranium contained in phosphate rocks, could extend resources to about 700 years (Table 4). The estimated 4 billion tonnes of uranium contained in seawater would constitute a virtually inexhaustible supply, if a method to extract it economically were to be developed.

The level of nuclear power production envisaged in the BLUE Map scenario would, on the basis of current fuel cycle technology and practice, result in uranium consumption of about 5.6 million tonnes between 2010 and 2050. However, several technological developments could increase the amount of energy produced from each tonne of uranium over the coming decades, thereby reducing total uranium consumption. These include improved operating and fuel management practices, advances in fuel design and materials, and higher thermal efficiencies in new and upgraded nuclear plants.

In addition, deployment of new enrichment technologies will have an impact. As there is a trade-off between the amounts of natural uranium and enrichment work required to produce a given quantity of enriched uranium, the proportion of the U-235 extracted from natural uranium depends largely on the relative costs of enrichment and natural uranium. The wider use of centrifuge enrichment technology, which has lower operating costs than older diffusion technology, is expected to lead to increased efficiency of uranium use.

As well as new centrifuge plants, more efficient advanced centrifuges will gradually replace older models within existing centrifuge plants. In addition, new enrichment technology using lasers is now being tested and plans are being considered to have the first commercial laser enrichment plant

Table 4. Approximate ratios of uranium resources to present annual consumption, for different categories of resources, showing also the potential impact of recycling in fast reactors

	<i>Known conventional resources</i>	<i>Total conventional resources</i>	<i>With unconventional resources</i>
With present reactors and fuel cycles	100	300	700
With fast reactors and advanced fuel cycles	> 3 000	> 9 000	> 21 000

Source: NEA, 2008.

in operation by around 2015. Such developments could potentially allow more U-235 to be extracted from existing stocks of depleted uranium, as well as permitting the more efficient use of newly mined uranium in the future.

Nevertheless, uranium demand in BLUE Map still represents a large part of currently known conventional uranium resources of about 6.3 million tonnes (NEA, 2010). However, as noted above, additional and unconventional resources could greatly extend the amount of uranium available. In response to higher uranium prices, annual uranium exploration expenditures have risen three-fold since 2002, from a low base. As nuclear power expansion gets underway, a further sustained increase in uranium exploration activity can be expected, with many regions having the potential for further major discoveries to replace exploited resources.

If uranium resources themselves are unlikely to be a limiting factor for the expansion of nuclear programmes, the timely availability on the market of adequate uranium supplies could be a cause for concern. Developing new mines, both to replace exhausted existing mines and expand overall production capacity, will require large investments over the coming decades. Licensing and developing new mines, often in remote areas, can take many years. The lesson of the recent past is that, even with the stimulus of higher uranium prices, production can take some years to respond.

Existing uranium mining companies and new entrants will be ready to invest in new capacity given the right price signals, and sufficient policy and regulatory certainty. Developers of nuclear power plants may seek to secure at least some of their uranium supply in advance of construction, through long-term contracts or even through direct investment in new production capacity. Governments of countries with commercially viable uranium resources have a role to play in ensuring a supportive policy environment and effective regulatory procedures.

Several different technologies exist for uranium extraction, and advances in mining technology could improve the viability of some uranium resources. Conventional underground and open-pit mining presently account for about 60% of production. In-situ leach (ISL) techniques have been more widely deployed in the last decade, now providing almost 30% of production. The advantages of ISL include lower up-front capital costs, the ability to exploit smaller deposits, and

lower environmental impacts. Uranium production as a by-product (usually of gold or copper) is also significant, and could be extended in future.

In the longer term, the commercial deployment of advanced reactors and fuel cycles that recycle nuclear fuel could permit much greater amounts of energy to be obtained from each tonne of uranium (Table 4). The development of such advanced nuclear systems will be further discussed later in this roadmap. Given the expected availability of uranium resources, the increase in nuclear capacity in the BLUE Map scenario by 2050 can be achieved without their large-scale deployment. However, if lower cost uranium resources become scarcer, the economic attractiveness of recycling nuclear fuel will increase.

As noted earlier, existing nuclear fuel cycle facilities for UF₆ conversion, enrichment and fuel fabrication are adequate for levels of demand expected in the next few years, and there are near-term plans for replacing and expanding capacities as required. In addition, countries where significant nuclear power programmes are underway, such as China and India, are planning to increase their domestic nuclear fuel capabilities. In general, nuclear fuel cycle capacities can be expanded in less time than it takes to build new nuclear generating capacity. Hence, security of supply for nuclear fuel cycle services should not, in principle, be a significant concern.

However, if nuclear capacity expands significantly after 2020 there will be a need for new large-scale facilities in additional countries. Building new conversion and fuel fabrication facilities as required should not cause difficulties. But the technology involved in enrichment is sensitive from a non-proliferation perspective, which will limit the potential locations for new facilities. For some countries concerned about security of energy supply, this may be a disincentive to rely on nuclear energy.

One solution could be to establish “black box” enrichment plants, where the host country would not have access to the technology. Discussions are also underway in international fora on creating mechanisms to provide assurances of nuclear fuel supply to countries that do not have their own enrichment facilities. Progress with such proposals could facilitate nuclear expansion in a broader range of countries after 2020. In the longer term, the development of proliferation-resistant advanced nuclear systems may offer technological solutions to this issue.

Box 2. An introduction to nuclear fission and the fuel cycle

Nuclear reactors and fission

Nuclear fission is the basic heat-producing process in a nuclear power plant. A heavy atomic nucleus absorbs a single nuclear particle (a neutron), causing it to split into two smaller nuclei (known as fission products), releasing further neutrons and heat energy. If, on average, one of these neutrons goes on to cause a further fission, a stable nuclear chain reaction is established. The heat is removed from the nuclear fuel by a coolant (usually water), and used to produce steam that drives a turbine-generator.

Only a few types of heavy nuclei are capable of fission (“fissile”). The main fissile nucleus (or isotope) in all but a handful of existing nuclear plants is uranium-235 (U-235), which comprises only 0.71% of natural uranium. For most reactor types, the proportion of U-235 in the fuel must be increased to 4–5% in an enrichment plant.

U-235 mainly fissions when it absorbs a slow (or “thermal”) neutron. As most neutrons produced are initially “fast” neutrons, the reactor must also contain a “moderator”, a material (usually water) that slows neutrons to thermal energy levels. The nuclear reaction is controlled by the insertion or removal of control rods, which contain neutron-absorbing materials.

The great majority of existing nuclear power plants, as well as most designs for new plants, use light water reactors (LWRs), which use ordinary water as both coolant and moderator. These are further divided into pressurised water reactors (PWRs), the most common type, and boiling water reactors (BWRs). A smaller number of plants use “heavy” water, which contains deuterium (an isotope of hydrogen). This is a more effective moderator, meaning that such plants can use unenriched uranium fuel. A few older plants use other reactor types (such as gas-cooled graphite-moderated reactors), but no such designs are currently being offered for new construction.

Manufacturing nuclear fuel

Nuclear fuel is a manufactured product, comprising (for most reactors presently in operation) ceramic pellets of enriched uranium dioxide (UO_2) encased in tubes of zirconium alloy, arranged in a lattice within a nuclear fuel assembly. In addition to uranium mining and the production of uranium ore concentrate, the “front end” of the fuel cycle consists of three main nuclear industrial processes:

- conversion of uranium ore concentrate to uranium hexafluoride (UF_6);
- enrichment of UF_6 (to increase the proportion of the fissile isotope U-235);
- fabrication of fuel assemblies (including preparation of UO_2 pellets from enriched UF_6).

Open and closed fuel cycles

Most nuclear fuel spends three or four years in the reactor. On being removed it typically contains about 96% uranium (of which most is U-238, with less than 1% U-235 and smaller amounts of other uranium isotopes), 3% waste products, and 1% plutonium. Spent fuel may be considered to be waste, to be stored in managed conditions and eventually disposed of in a geological repository. This is known as an “open” or “once-through” fuel cycle.

However, spent fuel can also be recycled in a “closed” fuel cycle, with the uranium and plutonium it contains being extracted and used to prepare further nuclear fuel. The waste products, which constitute high-level radioactive waste, are separated out for further treatment followed by interim storage, pending final disposal in a geological repository. Recycled uranium can be re-enriched in dedicated facilities and used to fabricate new fuel. Plutonium can be used in mixed uranium-plutonium oxide (MOX) fuel, in which plutonium is the main fissile component.

Advanced fuel cycles and fast reactors

Over 99% of natural uranium is U-238, which is a “fertile” isotope. This means that it does not fission in a reactor but can absorb a neutron to form (after further decay steps) fissile plutonium-239 (Pu-239). Plutonium fuel can be used in existing “thermal” reactors, but Pu-239 undergoes fission with fast neutrons more readily than U-235, and hence can be used to fuel reactors without a moderator, known as “fast” reactors.

In existing fuel cycles, which mainly make use of U-235, most of the uranium remains in the tailings from enrichment plants, with some 1.6 million tonnes of this “depleted” uranium estimated to be in storage. In a fast reactor, depleted uranium can be placed around the core in a “blanket”. U-238 it contains absorbs neutrons to create Pu-239, which is then chemically extracted to produce new fuel. This process is known as “breeding”, and can produce more nuclear fuel than it consumes. The large-scale use of breeding to turn U-238 into nuclear fuel would extend the lifetime of existing uranium resources for thousands of years (Table 4). This is discussed in more detail in the following section.

Technology development and deployment: actions and milestones

Evolutionary development of current technologies

This roadmap recommends that:

- While capturing the benefits of replicating standardised designs to the extent possible, the nuclear industry should continue the evolutionary development of reactor and nuclear fuel designs to benefit from experience gained in building reference plants and from technological advances, to ensure that nuclear power remains competitive.

Current designs of nuclear power plant have been developed on a commercial basis by the leading nuclear suppliers, often in consultation with major electricity utilities, to meet actual and anticipated demand for new nuclear capacity. This reflects the status of nuclear energy as a mature, commercialised technology. An important aim of both suppliers and their utility customers has been to produce standardised designs, that can be built with a minimum of adaptations to take account of local conditions and regulatory requirements. Although there are past examples of standardisation, in earlier practice each individual nuclear plant often had unique design features.

Making significant changes to these standardised designs will result in additional costs and increased uncertainties. This suggests that, once the designs currently being offered have been demonstrated by first-of-a-kind plants, there will be strong incentives to make the minimum of design adjustments for follow-on units. While some changes may be unavoidable to meet differing regulatory requirements, keeping such design changes under strict control, both during construction and in operation, will be vital if the potential benefits of standardisation are to be realised. Building a series of standardised designs will allow progressive improvements in the construction process, to reduce lead times and overall costs.

Nevertheless, at some point the potential benefits of making further evolutionary design changes are likely to outweigh the potential risks. This will depend largely on the preference of utilities ordering new nuclear plants. Many will prefer the

greater certainty of a tried and tested design, but others may wish to incorporate design refinements that offer the potential for improved performance and/or increased output. There may also be opportunities to introduce more advanced and efficient construction techniques. What is clear is that the continued evolutionary development of existing designs and the timing of the introduction of new features and enhancements will be essentially commercial decisions, intended to improve nuclear power's competitiveness.

In the fuel cycle, the development and deployment of new and improved technologies by commercial operators can be expected to improve the competitiveness of nuclear power over the coming years. In particular, deployment of more efficient centrifuge enrichment technologies, and potentially laser enrichment, will help improve fuel cycle economics. Continued development of improved fuel designs should also enhance fuel efficiency, as well as the reliability and performance of nuclear plants. In addition, the use of improved technologies and methods in maintenance procedures at nuclear plants should reduce the number and length of shutdowns, hence increasing plant output.

Implementing solutions for disposal of spent fuel and high-level waste

This roadmap recommends that:

- Governments should put in place policies and measures to ensure adequate long-term funding for the management and disposal of radioactive wastes and for decommissioning, and establish the necessary legal and organisational framework.
- Governments should ensure plans for the long-term management and disposal of all types of radioactive wastes are developed and implemented, in particular for the construction and operation of geological repositories for spent fuel and high-level waste.

As noted earlier in this roadmap, the main challenge for the future of radioactive waste management is to develop and implement plans for the eventual disposal of spent fuel and vitrified high-level waste. Long-lived intermediate-level waste may also be disposed of by the same route.

The approach being pursued worldwide is for the disposal of such materials in deep geological repositories. Several countries have built underground research laboratories in different geological settings to develop repository concepts and investigate factors affecting their long-term performance (Table 5). The scientific and technological bases for implementing geological disposal are thus well established. Several countries presently have active RD&D programmes aimed at opening repositories before 2050. If successfully implemented, these ongoing projects and plans will provide disposal routes for much of the spent fuel and high-level waste already accumulated and expected to be produced up to 2050.

Sweden and Finland are among the leaders in advancing plans to build and operate repositories. In both countries, sites have been selected and it is expected that the facilities will be in operation by around 2020. France is expected to follow by around 2025. Meanwhile, however, a policy decision has been taken to abandon a long running programme to develop a geological repository at Yucca Mountain in the US state of Nevada.

In the longer term, if recycling of spent fuel is introduced on a wide scale, then existing stocks of spent fuel, often treated as waste at present, could become an energy resource. Partly for this reason, some countries are designing their repositories to allow spent fuel to be retrieved, at least until a future decision on permanent sealing of the facility. The use of advanced fuel cycles could also reduce significantly the amounts of spent fuel and high-level waste to be disposed of. There would still be a need for some disposal facilities, but they could be smaller and/or fewer in number. These aspects will be discussed further in the following section.

Table 5. Underground research laboratories (URLs) for high-level radioactive waste disposal

Country	Geology	Site and status
Belgium	Clay	Mol. HADES URL in operation since 1984.
Finland	Granite	Olkiluoto. ONKALO URL under construction. R&D on site since 1992; the site has now been selected for a repository.
France	Clay/marl Clay	Tournemire. Underground test facility in operation since 1992. Bure-Saudron. URL in operation since 2004.
Germany	Salt (dome) Salt (dome)	Asse. Former mine used for R&D until 1997. Gorleben. Former mine. R&D on site from 1985 until suspended in 2000; suspension lifted in 2010.
Japan	Granite Sedimentary rock	Mizunami. URL in operation since 1996. Horonobe. URL under construction.
Russia	Granite, gneiss	Krasnoyarsk region. URL expected to start operation after 2015. It is planned that URL will be first stage of a repository.
Sweden	Granite Granite	Stripa. Former mine used for R&D from 1976 to 1992. Oskarshamn. Äspö URL in operation since 1995.
Switzerland	Granite Clay	Grimsel. URL in operation since 1983. Mont Terri. URL in operation since 1995.
United States	Salt (bedded) Welded tuff	Carlsbad, New Mexico. Waste Isolation Pilot Plant (WIPP) in operation since 1999 as geological repository for defence-related non-heat generating transuranic waste. Yucca Mountain, Nevada. R&D on site since 1996. Licence application for a repository in 2008, withdrawn in 2010.

Source: NEA, 2008 (updated).

Developing a new generation of nuclear technologies

This roadmap recommends that:

- Governments should continue to support RD&D of advanced nuclear technology to capture its long-term potential to provide sustainable energy with improved economics, enhanced safety and reliability, and stronger proliferation resistance and physical protection.
- The international community should continue to strengthen co-operation on the development of advanced reactor and fuel cycle technologies.
- The nuclear industry and utilities should participate, in co-operation with nuclear research institutes, in the development of next generation nuclear systems to ensure that the designs selected for demonstration are those most suitable for eventual commercialisation.

Nearly all nuclear units in operation or under construction make use of light or heavy water reactors. These established technologies and evolutionary designs based on them are expected to still dominate nuclear capacity in 2050. However, a few advanced systems could be available for commercial deployment in the 2030s, and such systems could become more widely available on the market after 2040.

RD&D efforts on these advanced nuclear systems are being pursued in several countries, mostly in the context of international programmes, in particular the Generation IV International Forum (GIF). Technological progress and some scientific breakthroughs will be needed in various domains (notably in materials science) in order to demonstrate and deploy such systems, which have significantly different characteristics than existing nuclear technologies.

Generation IV nuclear systems

Launched in 2001, GIF is an international project focusing on collaborative research and development (R&D) for selected innovative nuclear systems. Its membership comprises 12 leading nuclear energy countries (including Canada, China, France, Japan, Korea, Russia and the United States) plus Euratom (an arm of the European Union). The major goals set out in the GIF roadmap (GIF, 2002) are in the areas of sustainability, economics, safety and reliability, and proliferation resistance and physical protection (Box 3). The sustainability goals of GIF encompass more effective fuel utilisation and minimisation of waste. The main R&D efforts directed at these goals are described in the following section on advanced fuel cycles.

The economic objective of advanced nuclear systems is to be competitive with alternative energy options that will become available. To this end, the economic goals of GIF include reductions in both levelised lifetime cost of electricity generation and total capital cost. Ways to reduce costs are being integrated into the designs of advanced nuclear systems. Emphasis is being placed on design simplification and standardisation, enhanced construction methods, and factory fabrication of major components and systems.

The rationale behind the safety and reliability goals of GIF is that, although the overall record of nuclear power in these areas is good, public confidence needs to be increased. The aim is to build-in safety features to the designs of Generation IV plants, using advanced risk assessment methods and incorporating “passive” or “inherent” safety characteristics. Similarly, meeting the proliferation resistance and physical protection goal involves design features in reactors and fuel cycles that effectively prevent the misuse of nuclear materials and facilities, and that protect them from theft and terrorism.

The GIF goals were used to guide the selection of six systems for further collaborative R&D (Box 4). Several cross-cutting issues (including advanced fuel cycles) were also identified for horizontal efforts. Within the GIF framework, system arrangements for each selected technology are being established among countries participating in related R&D efforts. More detailed project arrangements for specific R&D areas are also being agreed.

Box 3. Goals for Generation IV nuclear energy systems

Generation IV nuclear energy systems will:

Sustainability

- Provide sustainable energy generation that meets clean air objectives and promotes long-term availability of nuclear fuel and effective fuel utilisation for worldwide energy production.
- Minimise and manage their nuclear waste and notably reduce the long-term stewardship burden, thereby improving protection for public health and the environment.

Economics

- Have a clear life-cycle cost advantage over other energy sources.
- Have a level of financial risk comparable to other energy projects.

Safety and reliability

- Have operations that excel in safety and reliability.
- Have a very low likelihood and degree of reactor core damage.
- Eliminate the need for off-site emergency response.

Proliferation resistance and physical protection

- Increase the assurance that they are a very unattractive and the least desirable route for diversion or theft of weapons-usable materials, and provide increased physical protection against acts of terrorism.

Source: GIF, 2002.

The six systems include technically very different reactor types. However, all are potentially compatible with the GIF goals, with each offering a number of advantages while facing specific R&D challenges. The present status of technological development of the six systems varies (GIF, 2009), with some concepts (notably the SFR and VHTR) having been the subject of significant past RD&D efforts. In addition, some concepts have so far attracted more commitments from GIF members than others.

The intention of pursuing a range of technological options is to allow the most promising systems to emerge over time. The overall aim is to permit demonstration of at least a few of the six systems by 2030, so that the first Generation IV systems will be available for commercial deployment before 2040. However, the scope of co-operation within the GIF framework does not so far extend to the demonstration phase. It is expected that governments, research organisations and industrial partners in participating countries will take separate initiatives at that stage, through either national or international projects.

Efforts to demonstrate VHTR technology are the most advanced, albeit at lower temperatures than those eventually envisaged. Such designs are

particularly suited for heat applications, and are discussed below in the section on non-electricity applications. Of the other technologies, the SFR is expected to be demonstrated first. Prototype SFRs have been built in a few countries in the past, and large operational SFRs exist in Russia and Japan. In 2006, France committed itself to building a demonstration Generation IV SFR, known as ASTRID, that could enter operation in the early 2020s. Japan aims to complete a demonstration Generation IV SFR by 2025.

The Sustainable Nuclear Energy Technology Platform (SNETP), launched in 2007, is a European initiative associated with the European Union's Strategic Energy Technology Plan. It involves research institutes, industry, academia and other stakeholders from across Europe. SNETP objectives include the demonstration of Generation IV nuclear systems and the use of nuclear energy for non-electricity applications. In particular, SNETP has established the European Sustainable Nuclear Industrial Initiative, which aims to design and construct two demonstration Generation IV fast reactors (one SFR and either a GFR or LFR) over the next 10-15 years.

Box 4. Concepts for Generation IV nuclear energy systems selected by GIF

Sodium-cooled Fast Reactor (SFR)

Several prototype SFRs have already been built and operated in a few countries, making it one of the best established Generation IV technologies. SFRs feature a fast neutron spectrum, liquid sodium coolant, and a closed fuel cycle. Full-sized designs (up to 1 500 MW) use mixed uranium-plutonium oxide fuel, with centralised recycling facilities. Small designs in the 100 MW range, using metallic fuel and co-located recycling facilities, are also being considered. SFRs have a relatively low (550 °C) outlet temperature, limiting their use for non-electricity applications. Reducing capital costs and increasing passive safety are important R&D aims, together with the development of advanced fuel reprocessing technologies.

Very High Temperature Reactor (VHTR)

The chief attraction of the VHTR concept is its ability to produce the higher temperatures (up to 1 000 °C) needed for hydrogen production and some process heat applications. However, VHTRs would not permit use of a closed fuel cycle. Reference designs are for around 250 MW of electricity, or 600 MW of heat, with a helium coolant and a graphite-moderated thermal neutron spectrum. Fuel would be in the form of coated particles, formed either into blocks or pebbles according to the core design adopted. VHTR designs are based on prototype high-temperature gas-cooled reactors built in the United States and Germany, and much R&D has been completed. Remaining challenges include developing improved temperature-resistant materials, and the fuel design and manufacture.

Super-Critical Water-cooled Reactor (SCWR)

Of the Generation IV designs, the SCWR is most closely related to existing LWR technology. SCWRs would operate at higher temperatures and pressures, above the thermodynamic critical point of water, allowing design simplification and greatly improved thermal efficiencies. Reference designs provide up to 1 500 MW, use uranium or mixed oxide fuel, and have outlet temperatures up to 625 °C. SCWRs could have either a thermal or a fast neutron spectrum; the latter would use a closed fuel cycle based on centralised fuel facilities. Major R&D challenges involve overcoming safety-related core design issues, as well as developing corrosion-resistant materials.

Gas-cooled Fast Reactor (GFR)

The GFR system reference design includes a 1 200 MW helium-cooled reactor with a fast neutron spectrum and a closed fuel cycle with an on-site spent fuel treatment and refabrication plant. It features a high thermal efficiency direct-cycle helium turbine for electricity generation. The high outlet temperature (850 °C) could also be suitable for hydrogen production or process heat. Key R&D challenges include the development of new fuels (such as ceramic-clad fuels or fuel particles) and materials, as well as the core design and the helium turbine.

Lead-cooled Fast Reactor (LFR)

The LFR system would feature a fast-spectrum liquid metal-cooled reactor and a closed fuel cycle. Molten lead is a relatively inert coolant, offering safety advantages as well as being abundant. Designs being investigated to date include both small (20 MW) and mid-sized (600 MW) designs. The former would be a factory-fabricated plant with a very long refuelling interval (15-20 years). Initially, LFRs would be developed for electricity production, but high temperature versions could allow hydrogen production. Major R&D needs are in fuels, materials and corrosion control.

Molten Salt Reactor (MSR)

In MSRs, fuel materials are dissolved in a circulating molten fluoride salt coolant. The liquid fuel avoids the need for fuel fabrication and allows continuous adjustment of the fuel mixture. The current concept is for a 1 000 MW fast neutron reactor with a closed fuel cycle. This could be used for breeding with fertile thorium or for burning plutonium and other actinides. An Advanced HTR with liquid fluoride salt coolant is also being studied. Molten salt chemistry, handling and corrosion resistance, as well as materials and the fuel cycle, are the main R&D challenges.

Source: GIF, 2002; GIF, 2009.

Advanced fuel cycles

Closed fuel cycles, involving the reprocessing of spent fuel and the recycling of fissile and fertile materials, which are included in most of the Generation IV concepts, hold the promise

of prolonging the lifetime of uranium resources by up to several millennia (Table 4). They could also reduce the need for uranium mining and the volumes of radioactive waste arising per unit of electricity generated. The more advanced cycles could also facilitate waste management by

Figure 8. Concept for a closed fuel cycle including fast reactors and advanced aqueous reprocessing technology

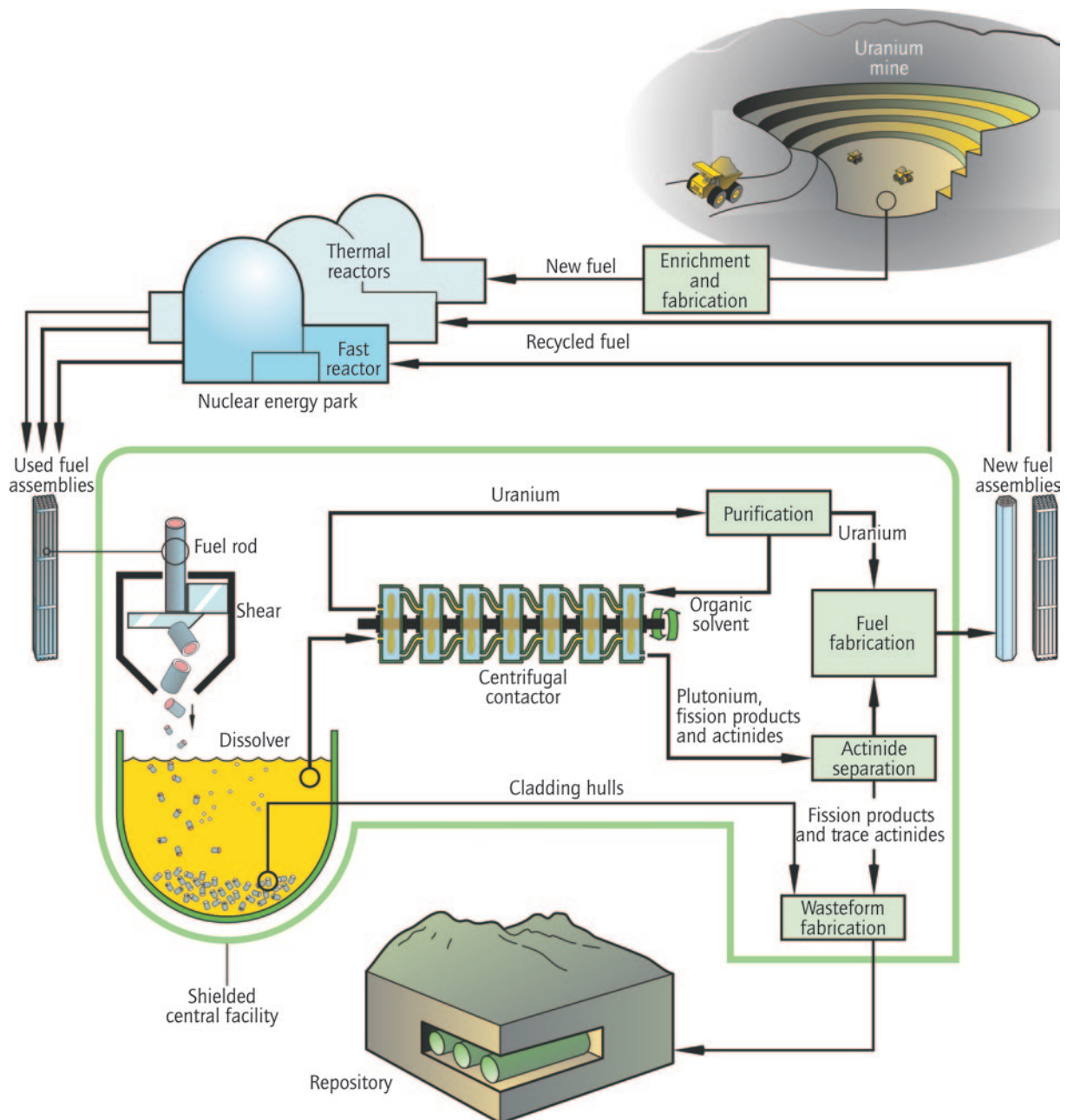

Source: GIF, 2002.

KEY POINT: Closed fuel cycles have the potential to extend uranium resources for several millennia.

reducing long-lived activity and hence minimising the quantities of high-level waste to be placed in geological repositories.

As noted earlier in this roadmap, the technologies for reprocessing spent fuel and recycling the uranium and plutonium it contains in new fuel have already been deployed on a commercial scale in a few countries. However, more advanced reprocessing technologies under development in the context of Generation IV systems could offer significant advantages in terms of economics, proliferation resistance and minimisation of waste. In particular, such technologies could avoid the separation of plutonium, thus easing proliferation concerns.

Several technological routes exist for developing advanced reprocessing/recycling, but two main strands of RD&D are now being pursued. The first is based on further development of present aqueous processes, involving the dissolution of spent fuel in acid and the chemical separation of its recyclable components and waste. Advanced aqueous reprocessing technology would first separate the bulk of the uranium, and then co-separate the remaining uranium along with plutonium and other actinides (Figure 8). The resulting U-Pu mixture would be used directly to fabricate mixed oxide fuel. As this is partly based on existing technology and experience, such advanced aqueous recycling could be ready for demonstration alongside the first Generation IV reactors.

The second major RD&D strand is “pyroprocessing” of spent fuel, involving high temperature non-aqueous techniques. Spent fuel in metallic form would be dissolved in molten salts or liquid metals. Such technology has a number of potential advantages, including the ability to carry out recycling on a small scale at reactor sites, avoiding the need for large centralised reprocessing plants. However, it is at an earlier stage of development, with some steps having only been performed at laboratory scale. Full demonstration is expected to be achieved by around 2030.

Reducing the volumes of high-level radioactive waste for eventual repository disposal depends on the ability of advanced cycles to “burn” (*i.e.* consume through nuclear reactions) the heavy long-lived isotopes (known as minor actinides or transuranics) formed in nuclear fuel during irradiation in the reactor. While highly active but short-lived fission products dominate the activity of spent fuel in the shorter term, minor actinides and a few long-lived fission products dominate in

the much longer timescales relevant for repository disposal. Hence, burning minor actinides can significantly reduce the long-lived component of high-level waste.

Another option for reducing volumes of long-lived waste is “partitioning and transmutation” (P&T). With P&T systems, minor actinides are chemically separated from the uranium and plutonium in recycled fuel. They can then undergo “transmutation”, involving irradiation in a dedicated reactor or a sub-critical accelerator-driven system (ADS). This causes nuclear reactions that change the minor actinides into shorter lived isotopes of lighter elements. The first demonstration of ADS transmutation could take place in the planned MYRRHA facility in Belgium, which is scheduled to begin operation by 2023.

Other initiatives on advanced nuclear systems

Another important international programme to support the development of advanced nuclear technologies is the International Project on Innovative Nuclear Reactors and Fuel Cycles (INPRO), organised by the International Atomic Energy Agency (IAEA), which includes 30 countries, both nuclear technology holders and users. The aim is to promote international and national actions that will support innovations in nuclear reactors, fuel cycles and institutional approaches. In particular, INPRO has defined a set of principles and requirements for assessing the sustainability of innovative nuclear systems, to guide members in their development efforts.

The Global Nuclear Energy Partnership (GNEP), originally launched by the United States in 2006, is a co-operative framework for countries seeking to expand the use of nuclear energy for peaceful purposes, in particular by encouraging the development and deployment of advanced reactors and fuel cycles. It currently has 25 full partner countries, with over 30 countries having observer status. The emphasis of GNEP is particularly on technological approaches to reducing the risk of proliferation of sensitive materials and technologies, while ensuring secure supplies of nuclear fuel. Development work will be carried out under existing and new bilateral arrangements, as well as through the GIF and INPRO frameworks.

Most countries’ RD&D efforts on advanced nuclear systems are being pursued in the context of one or more of the co-operative programmes

described above. India is separately pressing ahead with the demonstration of a sodium fast reactor, with a prototype currently under construction. However, this is not considered to be Generation IV technology. The aim is to follow this with a fleet of larger SFRs within the next 10 to 20 years.

In addition, India is the only country currently developing the potential of thorium fuel cycles, with a demonstration plant planned for around 2020 and a full prototype before 2050. Thorium is thought to be more abundant than uranium in the Earth's crust, and natural thorium (comprising the isotope Th-232) can be irradiated in a reactor to create the fissile isotope U-233. This can be extracted in a reprocessing plant and used to create new fuel. However, thorium fuel cycles have not yet been fully demonstrated at large scale and several important technical challenges remain, particularly in the reprocessing of thorium fuel.

Status and potential of small modular reactors

Designs for small modular reactors (SMRs), with generating capacities ranging from tens to a few hundred megawatts, are being developed in several countries, often through co-operation between government and industry. Countries involved include Argentina, China, Japan, Korea, Russia, South Africa and the United States. SMR designs encompass a range of technologies, some being variants of the six Generation IV systems selected by GIF, while others are based on established LWR technology.

Such reactors could be deployed as single or double units in remote areas without strong grid systems, or to provide small capacity increments on multi-unit sites in larger grids. They feature simplified designs and would be mainly factory-fabricated, potentially offering lower costs for serial production. Their much lower capital cost and faster construction than large nuclear units should make financing easier. Other advantages could be in the area of proliferation resistance, as some designs would require no on-site refuelling, while others would only require refuelling after several years. Some could be used with advanced fuel cycles, burning recycled materials.

Numerous concepts exist for SMRs based on LWR technology. Several such designs are being promoted by nuclear industry companies,

including AREVA, Babcock & Wilcox, General Atomics, NuScale and Westinghouse. Others are being developed by national research institutes in Argentina, China, Japan, Korea and Russia. Two small units designed to supply electricity and heat are under construction in Russia, based on existing ice-breaker propulsion reactors; these will be barge-mounted for deployment to a remote coastal settlement on the Kamchatka peninsula. Some other designs are well-advanced, with initial licensing activities underway. Demonstration plants could potentially be in operation before 2020, if funding becomes available. However, no firm commitments have been made to date.

Several SMR designs are high-temperature gas-cooled reactors (HTRs). The Generation IV VHTR concept is an extension of this technology for even higher temperatures. HTRs and VHTRs are well-suited to heat or co-generation applications, as discussed further in the following section.

There are also several other concepts for advanced SMR designs, including liquid metal-cooled fast reactors. These are generally at an earlier stage of development, with some the subject of GIF collaborative R&D efforts. One of the best developed is the 4S design from Toshiba of Japan, a sodium-cooled "nuclear battery" system capable of operating for 30 years with no refuelling. It has been proposed to build the first such plant to provide 10 MW of electricity to a remote settlement in Alaska, and initial licensing procedures have begun. Other concepts for advanced SMRs have been proposed by commercial and research organisations in several countries, and some aim to commence licensing activities in the next few years. However, no firm plans to construct demonstration plants have yet been announced.

If multiple modular units on a single site were to become a competitive alternative to building one or two large units, then SMRs could eventually form a significant component of nuclear capacity. They could also enable the use of nuclear energy in locations unsuitable for large units, and some designs could extend its use for non-electricity applications. However, whether SMR designs can be successfully commercialised, with an overall cost per unit of electricity produced that is competitive with larger nuclear plants and other generating options, remains to be seen. For the purposes of this roadmap, it is assumed that the great majority of nuclear capacity by 2050 will be provided by larger scale plants.

Nuclear energy as an alternative for heat and transport

Since nuclear power plants are generally operated continuously to produce baseload electricity, they will increasingly contribute to the transportation sector as a low-carbon source of mainly off-peak electricity for charging electric and plug-in hybrid vehicles, as the use of such vehicles grows over the coming decades. The wider use of such vehicles and other electric transport options, and the resulting increased electricity demand, are incorporated into the BLUE Map scenario on which this roadmap is based.

Although the BLUE Map scenario only considers the use of nuclear energy for electricity production, nuclear also has considerable potential to penetrate non-electricity energy sectors in the 2050

timeframe. Possible applications include industrial process heat (including for petro-chemical industries), district heating, seawater desalination, and electricity and heat for hydrogen production.

There are a few examples of heat from nuclear plants being used for such purposes, but the potential of nuclear energy in non-electricity energy markets has so far remained largely unrealised. If this is to change, nuclear energy systems will need to be adapted to the requirements of these markets. In particular, the commercialisation of HTRs could extend the heat applications of nuclear energy. Small prototype HTRs are in operation in China and Japan, and larger prototypes were built in Germany and the United States some years ago.

A pair of demonstration HTRs under construction in China for commissioning in 2013 will provide heat plus 200 MW of electricity. In the United

Figure 9. Schematic for a Generation IV Very High Temperature Reactor (VHTR) used for hydrogen production

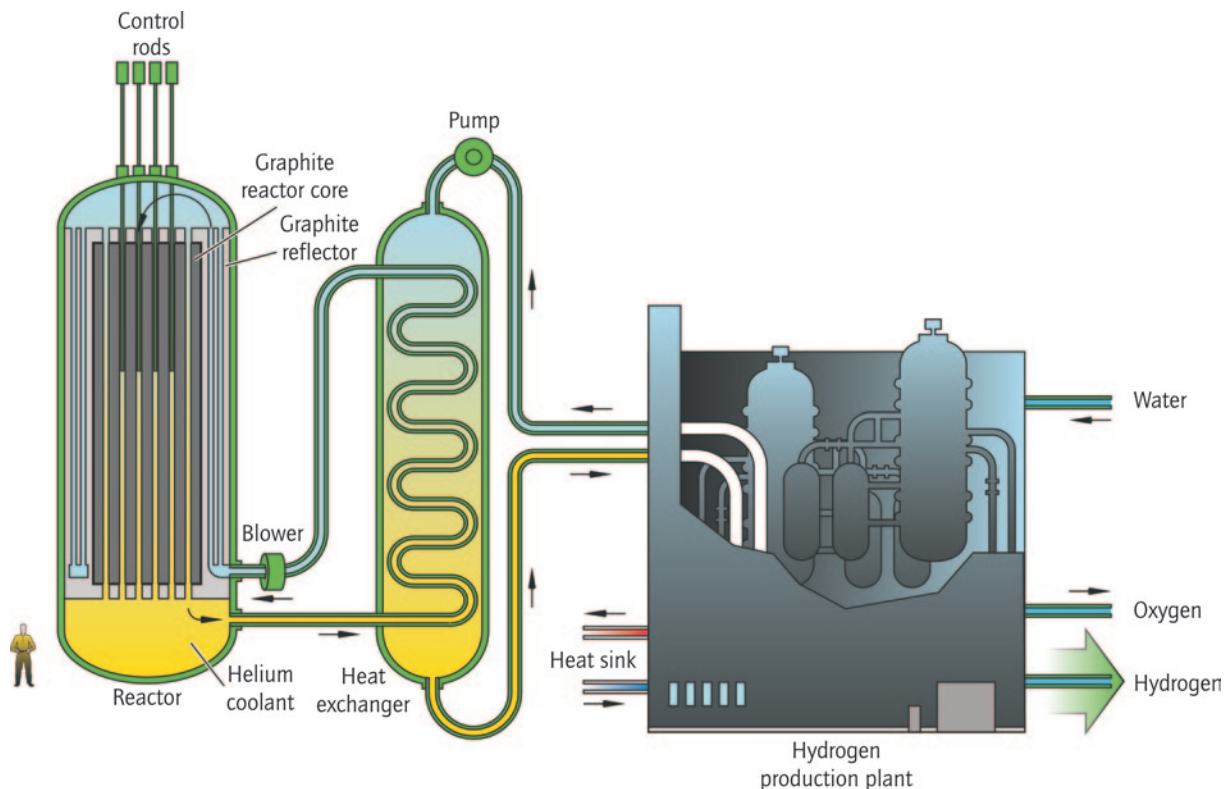

Source: GIF, 2002.

KEY POINT: Some Generation IV designs will provide the high temperatures needed for hydrogen production and other heat applications.

States, the Next Generation Nuclear Plant (NGNP) project aims to demonstrate the feasibility of using HTR technology for hydrogen production and high-temperature process heat. Subject to funding, the NGNP could be in operation before 2025. Development of HTR technology is also being pursued in Japan, Korea and Europe. However, plans to build a demonstration modular HTR in South Africa have been shelved due to lack of financial support.

Among the Generation IV designs selected by GIF for further development, the VHTR is specialised for high-temperature heat applications (Figure 9).

This will be a development of HTR designs, adapted for even higher temperatures. Achieving these higher temperatures will require further R&D, especially of heat-resistant materials. Several other Generation IV designs are also capable of producing higher temperatures than existing reactors, extending the scope of their potential non-electricity applications.

Meeting demand for small-scale non-electricity applications, such as distributed hydrogen production or desalination in sparsely populated areas, could eventually be an important role for the small modular reactors discussed above.

Policy, financial and social aspects: actions and milestones

The importance of strong policy support

For countries pursuing a nuclear programme, this roadmap recommends that:

- Governments should provide clear and sustained political support for the nuclear programme, as part of national strategy to meet energy and environmental policy objectives.
- Governments should work with the nuclear and electricity industries to ensure a co-ordinated approach to overcoming obstacles to nuclear development, especially where nuclear energy is being used for the first time or after a long period with no new nuclear capacity.

Clear and sustained government policy support is an essential prerequisite for a successful nuclear programme. Normally this will be part of the country's overall long-term strategy to meet its energy policy and environmental objectives, including achieving security of energy supply and controlling greenhouse-gas emissions. Examples of countries with such long-term policies to develop nuclear energy include France, Japan, Korea and, more recently, China.

The need for strong policy support applies equally in cases where the electricity supply industry is in the private sector. No investor would contemplate proceeding with a project to construct a nuclear power plant in the face of government opposition, and even a neutral or uncommitted stance from the government is likely to deter investors.

There have been several cases where nuclear power projects were delayed or cancelled, or operating plants were forced to close prematurely, as a result of policy changes regarding nuclear power. Given that the construction period of a nuclear plant may include national elections, and that there will be several changes of government during the plant's operating life, there is likely to be a need not only for policy support from the incumbent government, but also a long-term settled strategy with broad-based political support. Developing such a strategy will involve

conducting public consultations and debates to achieve a national consensus on the way forward.

Launching a new nuclear programme will require the government to take a particularly active role. In some countries, the electricity supply industry is wholly or mainly under state control, and the decision to proceed with a nuclear programme will be taken directly by the government. In other cases, the government will need to work closely with the private and public sector actors involved to ensure that projects can proceed smoothly. This will clearly include establishing the required legal and regulatory frameworks (as discussed below), but it will often be necessary for the government to take a broader role.

Establishing the legal and regulatory frameworks

This roadmap recommends that:

- In countries with existing nuclear programmes, governments should ensure that the system of nuclear energy-related legislation and regulatory oversight makes an appropriate balance between protecting the public and the environment, and providing the certainty and timeliness required for investment decisions.
- In countries launching new nuclear programmes, governments should observe international best practice in developing the necessary nuclear energy legislation and regulatory institutions, to ensure that they are both effective and efficient.
- Governments should facilitate the construction of standardised designs for nuclear power plants worldwide by harmonising regulatory design requirements to the extent possible.

Any country intending to launch a nuclear programme needs to have in place an appropriate legal framework dealing with nuclear-related matters. This includes establishing a system

for regulating, licensing and monitoring nuclear activities and facilities, overseen by an independent and adequately resourced agency. Other necessary legal provisions include defining responsibility for radioactive wastes and decommissioning, establishing a nuclear liability regime (which for many countries includes adherence to international conventions) and a system for physical protection and accounting of nuclear materials. Many countries have a specific “nuclear energy act” that deals with all aspects of the use of nuclear energy.

In addition, environmental and local planning regulations will also be relevant for nuclear projects, and must work effectively. For countries with a federal system of government, a clear division of responsibilities between state and federal levels of government is desirable, to avoid duplication of regulatory hurdles.

In countries with existing nuclear programmes, that have established legal and regulatory systems for nuclear energy, the main issue in contemplating a further expansion of nuclear power is the effectiveness and efficiency with which the existing system works. In some cases, licensing systems and associated procedures have proved to be a source of unnecessary delays in nuclear plant construction, and reforms may be needed to avoid this.

Important reforms to the licensing process in the United States, for example, have resulted in a one-step licensing process, with a combined construction and operating licence. There is also the ability to pre-licence nuclear plant designs and potential sites independently of each other. The first applications under this new system have now been made and are under consideration by the Nuclear Regulatory Commission. Other established nuclear countries have also reformed their licensing systems to some extent, in an attempt to reduce the potential for delays.

Beyond enhancing the effectiveness of national regulatory frameworks, international co-operation could facilitate the licensing of new reactor designs. This could be an important factor in support of the deployment of nuclear power worldwide, allowing established standardised designs to be replicated in different countries with the minimum of design changes.

The Multinational Design Evaluation Programme (MDEP) is an example of international co-operation in the area of nuclear regulation. It is an initiative taken by the national nuclear regulatory authorities of ten countries, with the support of the NEA, aimed at making more effective use of the resources and knowledge of the authorities tasked with the review of new nuclear plant designs (MDEP, 2009). The main objective of the MDEP effort at present is to establish reference regulatory practices. So far, MDEP does not aim to establish any common regulations or binding commitments among its members.

A significant convergence of nuclear regulatory practices and regulations would streamline regulatory reviews of standardised reactor designs and facilitate national licensing processes for imported plants. Such harmonisation is likely to require intergovernmental agreement and stronger organisational arrangements. The eventual aim would be for national regulators to accept the conclusions of design reviews conducted by other regulators without having to duplicate the work themselves. This is an ambitious goal, and its full achievement could take many years. But if a significant degree of harmonisation were in place by the 2020s it could greatly assist the rapid expansion of nuclear energy envisaged in the BLUE Map scenario.

Countries without an existing nuclear regulatory and legal infrastructure that are planning new nuclear programmes have the ability to learn from international best practice. Given that there are different approaches to nuclear regulation and legislation among established nuclear countries, new entrants have sometimes adopted the main principles of the country from which they plan to acquire nuclear technology. This simplifies the licensing process, as the reference plant will normally already have been licensed in its country of origin, so a similar regulatory approach should avoid the need for design changes. However, in the absence of broader international harmonisation, this may make it more difficult to later use alternative suppliers.

Internationally agreed codes and standards on nuclear safety are also important in spreading best practice. The IAEA promotes a global safety regime, covering nuclear power plants, the fuel cycle and radioactive waste, that is underpinned by several international conventions and codes of conduct. These include the Convention on

Nuclear Safety, that establishes benchmarks to which participating countries can subscribe. The European Union's Nuclear Safety Directive enshrines this convention into EU law.

Financing new nuclear power plants

This roadmap recommends that:

- Governments should ensure that the structure of electricity markets and, where appropriate, carbon markets supports the large, long-term investments required in nuclear power plants, providing sufficient confidence of an adequate return on investment.
- Governments should encourage investment in low-carbon electricity sources, including new nuclear capacity, through policies and measures designed to reduce CO₂ emissions, such as carbon trading schemes, carbon taxes or mandates on utilities to use low carbon sources.
- Governments should consider some form of support or guarantee for private sector investment in new nuclear plants, where the risk-reward ratio would otherwise deter potential investors, given that nuclear plants require very large investments with long pay-back periods.
- The global financial community should enhance its ability to assess the investment risks involved in nuclear power projects, to develop appropriate financing structures, and to provide suitable financial terms for nuclear investments.

The total estimated investment required worldwide over the next four decades to expand nuclear capacity in line with the BLUE Map scenario is, on the basis of the assumptions in the IEA's ETP model, almost USD 4 trillion (Table 6). This represents about 19% of the total estimated investment in electricity generating capacity in BLUE Map of USD 21 trillion over the period.

A recent major study by the IEA and NEA of projected electricity generating costs for almost 200 proposed power plants in 17 OECD and four non-OECD countries for commissioning in 2015 found that nuclear electricity is generally competitive with other generating options on a levelised lifetime cost basis (IEA/NEA, 2010). Despite this, in many cases financing the construction of new nuclear power plants is expected to be a challenge, especially in the context of liberalised electricity markets (NEA, 2009).

This is due to several special factors that have an impact on the financial risks of nuclear projects as perceived by potential investors, including:

- The high capital cost and technical complexity of nuclear plants, which present risks during both construction and operation.
- The relatively long period required to recoup investments or repay loans, which increases the risk from electricity and carbon market uncertainties.
- The often controversial nature of nuclear projects, which gives rise to additional political and regulatory risks.

The key to successful financing of nuclear power plants, as with other large infrastructure projects, is first to minimise the financial risks, and then to structure projects using appropriate ownership and contracting models so that the remaining risks are shared among the parties involved. With nuclear, governments will have an important role, at least in the first of these steps.

The streamlining of regulatory regimes to ensure they work effectively and efficiently will go some way to reducing financial risks. Other steps that only governments can take include establishing institutional and financial arrangements for radioactive waste management and disposal and for eventual decommissioning of nuclear plants. In addition, governments will need to ensure that electricity market arrangements provide sufficient investor confidence that long-term price levels will enable an adequate return on investment. The regulated electricity prices in some markets will help provide such confidence, but in liberalised markets price risks will usually be greater. Incentives for investment in low-carbon energy sources, such as carbon trading, carbon taxes or long-term contracts with minimum prices, could also encourage nuclear investments.

Table 6. Estimates from IEA ETP model for investment in nuclear energy in the BLUE Map scenario (constant 2008 USD)

Region/country	Estimated investment required (USD billions)			
	2010-2020	2020-2030	2030-2040	2040-2050
United States & Canada	75	342	243	224
OECD Europe	60	333	105	88
OECD Pacific	68	296	153	97
China	57	193	295	350
India	9	57	91	230
Latin America	11	30	36	39
Other developing Asia	5	39	24	39
Economies in transition	55	156	80	39
Africa & Middle East	2	23	18	12
World	342	1 469	1 045	1 118

Source: IEA, 2010.

The high investment cost of a nuclear plant means that its overall economics, and the feasibility of its financing, depend greatly on the cost of capital (essentially, the interest rate on loans and/or the rate of return on investment). Once supportive policies and measures are in place, in some countries there are very large, well-capitalised electricity utilities that are able to finance nuclear construction, at least for a limited number of plants. Some of these are fully or partly state-owned, while others are vertically integrated (giving them direct access to electricity customers), which should help reduce their cost of capital. To some extent, utilities may be able to share risks with nuclear plant suppliers and other contractors, and with other investors (including banks and investment funds). However, for the present at least, the latter are not expected to have a great appetite for nuclear investments.

In situations where utilities lack sufficient capital and/or electricity markets are more competitive, direct support for nuclear energy investments may be considered by some governments, to give an impetus to new nuclear construction by lowering the cost of capital. One example of this is the loan guarantee programme adopted in the United States, which could provide over USD 50 billion in guarantees to support new nuclear construction in the next few years. Other measures to support

nuclear financing could include government export credits, guaranteed minimum carbon prices, or long-term electricity purchase contracts. In some countries, support from multilateral development banks and agencies could play a role.

Beyond around 2020, provided that construction and early operation of the first-of-a-kind Generation III plants now being built and the immediate follow-on projects are successful, nuclear financing by the private sector may become easier. Indeed, such a development will be necessary if nuclear investment on the scale envisaged in the BLUE Map scenario is to occur. In the meantime, banks and other financial institutions will need to develop their expertise to properly assess the risks of nuclear financing, by studying early projects and by at least limited participation during the next decade.

In the longer term, the creation of a level playing field for all low-carbon energy technologies would be desirable, as these technologies mature and rely less on targeted government support. This will ensure that the most cost-effective options for reducing CO₂ emissions in each country and region are adopted to the maximum extent.

Involvement of civil society

This roadmap recommends that:

- Governments should communicate with stakeholders and the public to explain the role of nuclear energy in national energy strategy, seeking to build public support through involvement in the policy-making process.

Introducing nuclear energy or expanding its role requires building support from all stakeholders in civil society, including the public at large, based upon a rational assessment of its risks and benefits. Although concerns about security of energy supply and the threat of global climate change have tended in recent years to increase public recognition of the benefits of nuclear energy, several factors continue to weaken public support in many countries. These include concerns about nuclear safety, radioactive waste management and disposal, and the potential proliferation of nuclear weapons. Civil society is often reluctant to accept nuclear energy, mainly because its benefits are not perceived to outweigh its drawbacks.

The establishment of communication channels with all stakeholders is a necessary step towards promoting better understanding of the risks and benefits of nuclear energy, and the role it can play alongside other energy options. Beyond provision of information, however, civil society should be engaged in the policy-making process for deciding the future of nuclear energy programmes, in the context of overall national strategy to meet energy and environmental policy goals. Enhancing public involvement in shaping the future of nuclear energy is essential to build trust and ensure broad support.

In addition to nuclear power plants themselves, the siting of related fuel cycle facilities can also lead to public concerns and opposition. In particular, locating radioactive waste storage and disposal facilities has often become highly controversial. In several countries, proposals for such facilities have had to be withdrawn in the face of public opposition.

Lessons have been learned from such setbacks, and radioactive waste management organisations in most countries are now making much greater efforts to engage with local communities potentially affected. In some cases, notably in Finland and Sweden, this approach has resulted

in great progress being made towards the implementation of radioactive waste disposal plans. Other countries will need to adopt similar approaches as they seek to make progress with radioactive waste disposal.

Capacity building in countries planning a nuclear programme

This roadmap recommends that:

- The international community should continue to strengthen co-operation on institution-building in countries planning new nuclear programmes.
- In countries without an existing nuclear industry, governments should provide support to domestic industry in developing capacities and expertise to participate effectively as sub-contractors and component suppliers in nuclear power plant projects both at home and abroad.

If nuclear energy is to play a more significant role in the supply mix worldwide, nuclear power programmes will need to be implemented in an increasing number of newly industrialising countries, where most of the increase in energy and electricity demand will occur. The construction and operation of nuclear power plants in these countries will require technology transfer and capacity building.

The policies of OECD countries and others with established nuclear programmes regarding technical co-operation and assistance in the nuclear field will be very important in this regard. In countries embarking on nuclear power programmes, it is essential to ensure that the necessary regulatory frameworks and legal infrastructures are working effectively before the first units are built and commissioned. New nuclear countries also need to develop a “safety culture” among all those involved, including contractors, sub-contractors and operators, as well as regulators. Clearly, those countries involved in exporting nuclear plants to new nuclear countries have a responsibility to help develop the necessary legal infrastructure and expertise.

There is also an important role here for broader international co-operation, including through intergovernmental agencies. The IAEA in particular has developed a series of guides to assist its member states wishing to embark on nuclear power programmes, based on a set of milestones for the development of national infrastructure (IAEA, 2007). At present, the agency is working with over 30 member states that are considering a future nuclear programme.

For many countries launching a nuclear programme, developing the capabilities of domestic industries and research institutes will be an important consideration. As such, local content requirements will often be part of the tendering process and contract negotiations with nuclear suppliers (who may form consortia with local partners). Aims can range from the establishment over time of a full-scale domestic nuclear industry, to the involvement of local engineering industries as sub-contractors for construction services and components. Once nuclear plants are in operation, some support and maintenance services may also be provided locally. As well as reducing the import costs of nuclear plants, local content can provide a spur to high-technology industrial development. It also helps to broaden global supply chains, as such industries can become exporters at a later stage.

Non-proliferation, physical protection and security of nuclear fuel supply

This roadmap recommends that:

- The international community should maintain and strengthen where necessary co-operation in non-proliferation and nuclear law, physical protection of nuclear facilities and materials, and security of nuclear fuel supply.

Some nuclear technologies and materials have the potential to be misused for non-peaceful purposes. The 1968 Treaty on the Non-Proliferation of Nuclear Weapons (NPT) is the cornerstone of international efforts to combat this threat. In addition, the Nuclear Suppliers Group, an informal association of 46 countries, issues guidelines for the transfer of nuclear equipment, materials and technology between countries.

The great majority of countries adhere to the NPT, which requires them to submit to inspections of their nuclear facilities by the IAEA. However, many countries have not yet adopted a 1997 additional protocol that gives the IAEA strengthened rights to inspect sites and obtain information. There have been a small number of cases where existing non-proliferation controls have not prevented the spread of sensitive technologies, and some countries remain outside their scope, including a few with significant nuclear activities. Particularly if nuclear power is to play a greatly increased role, and is to be used in a wider range of countries, appropriate non-proliferation controls will need to be in place.

Some countries are concerned that stronger non-proliferation controls could restrict their ability to develop their own nuclear fuel cycle facilities, particularly those for uranium enrichment and reprocessing of spent fuel, which use the most sensitive technologies. This could limit their energy independence if they rely extensively on nuclear power. As a result, current efforts are centred on reinforcing security of nuclear fuel supply for countries using or planning to use nuclear energy that have good non-proliferation credentials, thereby removing the incentive for them to develop their own national facilities for enrichment and/or reprocessing.

Several international projects and proposals aimed at achieving this are being promoted by individual countries or groups of countries, and are being considered at the IAEA. These include measures such as the creation of one or more nuclear fuel banks (stockpiles of enriched uranium) under IAEA control, or establishing multilateral fuel cycle facilities. An agreement on setting up the first IAEA fuel bank, to be hosted on Russian territory, was signed in March 2010. Russia is also promoting one of its enrichment sites as a multilateral fuel cycle centre. However, it remains unclear whether such initiatives will become widely accepted and can be implemented on a large scale.

The physical protection and accounting of nuclear materials are primarily the responsibility of each country using nuclear technology. As noted above, appropriate legal and institutional arrangements need to be in place before nuclear activities can begin. However, heightened concerns about terrorism have made the security of nuclear materials an issue for the international community. International co-operation will be needed to spread best practice and to provide confidence that all nuclear materials are secure.

Roadmap action plan

This section summarises the actions identified in this roadmap needed to achieve the target nuclear capacity set out in the ETP BLUE Map scenario. They are sorted to indicate the stakeholders with the lead responsibility for implementation. The timescales given are approximate and will vary from country to country. In particular, countries

without an existing nuclear programme will need to take additional capacity and institution building steps that may require more time. It should be noted that these actions will apply only in countries where a national policy decision has been taken to have a nuclear programme.

Actions led by governments and other public bodies

Policy support	Milestones and actors
<ul style="list-style-type: none"> Provide clear and sustained political support for a nuclear energy programme, as part of a national strategy to meet energy and environmental policy objectives. 	<p>In place in several major countries; for other countries pursuing a nuclear programme, by 2015.</p> <p>Government leaders, energy/ environment departments.</p>
<ul style="list-style-type: none"> Communicate with stakeholders and the public to explain the role of nuclear energy in national energy strategy, seeking to build public support through involvement in the policy-making process. 	<p>Ongoing, as nuclear programmes are launched or re-activated.</p> <p>Political leaders, energy departments.</p>
<ul style="list-style-type: none"> Work with the nuclear and electricity industries to ensure a co-ordinated approach to overcoming obstacles to nuclear development, especially where nuclear energy is being used for the first time or after a long period with no new nuclear capacity. 	<p>Ongoing, as nuclear programmes are launched or re-activated.</p> <p>Energy/industry departments.</p>
<ul style="list-style-type: none"> Given that nuclear power plants require very large investments with long pay-back periods, consider providing some form of government support or guarantee for private sector investment in new nuclear plants, where the risk-reward ratio would otherwise deter potential investors. 	<p>For relevant countries, by 2015.</p> <p>Energy/finance departments.</p>
<ul style="list-style-type: none"> Encourage investment in low-carbon electricity sources, including new nuclear capacity, through policies and measures designed to reduce CO2 emissions, such as carbon trading schemes, carbon taxes or mandates on electricity suppliers to use low-carbon sources. The eventual aim should be to encourage the most cost-effective emissions reductions through technology neutral measures. 	<p>For countries pursuing a nuclear programme, by 2015-20.</p> <p>Energy/environment departments, legislators.</p>
<ul style="list-style-type: none"> Put in place policies and measures to ensure adequate long-term funding for management and disposal of radioactive wastes and for decommissioning, and establish the necessary legal and organisational framework for the development and timely implementation of plans for radioactive waste management and disposal. 	<p>Implemented in many countries with nuclear energy; for other countries pursuing a nuclear programme, in advance of reactor operation, by 2015-20.</p> <p>Energy/environment departments, legislators.</p>

Legal and regulatory frameworks	Milestones and actors
<ul style="list-style-type: none"> For countries with existing nuclear programmes, ensure that the system of nuclear energy-related legislation and regulatory oversight provides an appropriate balance between protecting the public and the environment while providing the certainty and timeliness required for investment decisions, and make reforms if required. Where applicable, this should extend to uranium mining and nuclear fuel cycle facilities. 	<p>Reforms introduced in some countries; others may need to follow by 2015.</p> <p>Energy/legal departments, legislators, nuclear regulators.</p>
<ul style="list-style-type: none"> For countries launching new nuclear programmes, observe international best practice in developing the necessary nuclear energy legislation and regulatory institutions, to ensure that they are both effective and efficient. 	<p>For relevant countries, by 2015-20.</p> <p>Energy/legal departments, legislators, nuclear regulators.</p>
<ul style="list-style-type: none"> Ensure that the structure of electricity markets and, where appropriate, carbon markets supports the large, long-term investments required in nuclear power plants, providing sufficient confidence that income achieved will provide an adequate return on investment. 	<p>As nuclear programmes are launched, by 2015-20.</p> <p>Energy/legal departments, legislators, market regulators.</p>
<ul style="list-style-type: none"> To the extent possible, facilitate the construction of standardised designs for nuclear power plants worldwide by harmonising regulatory design requirements. In particular, countries introducing new nuclear programmes should avoid imposing unique requirements. 	<p>Common requirements should be established from 2020.</p> <p>Energy/legal departments, legislators, nuclear regulators.</p>

Industrial development, education and training	Milestones and actors
<ul style="list-style-type: none"> For countries launching or re-activating nuclear programmes, ensure that suitably qualified and skilled human resources are available to meet the anticipated needs of the nuclear programme, including in government, electricity utilities, industry, and regulatory agencies. Countries with major nuclear industries will also need sufficient human resources to support nuclear exports. 	<p>Action by 2015 to ensure a significant increase before 2020.</p> <p>Education/employment departments, universities.</p>
<ul style="list-style-type: none"> For countries without an existing nuclear industry, provide support to domestic industry in developing capacities and expertise to participate effectively as sub-contractors and component suppliers in nuclear power plant projects both at home and abroad. Given the global nature of supply chains for nuclear construction, almost all countries will require the participation of foreign suppliers. 	<p>For relevant countries, by 2015-20.</p> <p>Energy/industry departments.</p>

Technology development and deployment	Milestones and actors
<ul style="list-style-type: none"> Develop where necessary and implement plans for the long-term management and disposal of all types of radioactive wastes, in particular for the construction and operation of geological repositories for spent fuel and high-level waste. This includes providing support for required RD&D activities. 	<p>The first repositories to be in operation by 2020, with other major nuclear countries following before 2030.</p> <p>Energy/environment departments, radioactive waste management agencies, waste generators.</p>
<ul style="list-style-type: none"> Continue to support RD&D of advanced nuclear technology (reactors and fuel cycles) to capture its long-term potential to provide sustainable energy with improved economics, enhanced safety and reliability, and stronger proliferation resistance and physical protection. 	<p>Demonstrate the most promising next generation nuclear systems by 2030, with full commercialisation after 2040.</p> <p>Energy/research departments, nuclear research institutes.</p>

Actions led by the nuclear and electricity supply industries

Managing the existing nuclear fleet	Milestones and actors
<ul style="list-style-type: none"> While continuing to operate existing nuclear plants safely and efficiently, invest in upgrading and preparing for extended lifetimes where feasible. To this end, ensure that lessons learned are widely disseminated among nuclear plant operators. 	<p>Ongoing, with significant investment needed by 2015.</p> <p>Electricity utilities, nuclear suppliers.</p>
Deploying new nuclear capacity by 2020	Milestones and actors
<ul style="list-style-type: none"> Fully establish the latest nuclear power plant designs by constructing reference plants in a few countries around the world, to refine the basic design and any regional variants, and build up global supply chains and capacities. 	<p>Several new designs now under construction will be in operation by 2015; others to follow in the next few years.</p> <p>Nuclear suppliers, supply chain industries, electricity utilities.</p>
<ul style="list-style-type: none"> Go on to demonstrate that these new designs can be reliably built on time and within expected costs, making continuous efforts to reduce construction times and control costs by using standardised designs to the extent possible, refining the construction process and further strengthening supply chains. 	<p>Demonstrate the ability to build standardised designs on time and to cost by 2020.</p> <p>Nuclear suppliers, supply chain industries, electricity utilities.</p>

Capacity building for rapid expansion after 2020	Milestones and actors
<ul style="list-style-type: none"> Invest in building up industrial capacities in the nuclear and related engineering industries worldwide to increase the global capability to build nuclear power plants, broadening supply chains while maintaining the necessary high quality and safety standards. A commensurate increase in skilled human resources will also be needed. 	<p>Significant investment needed by 2015 if global capacity is to double from present levels by 2020.</p> <p>Nuclear suppliers, supply chain industries, banks and other investors.</p>
<ul style="list-style-type: none"> Expand uranium production and the capacity of nuclear fuel cycle facilities in line with the growth of nuclear generating capacity, including the deployment of more efficient advanced technologies where available. 	<p>Major capacity expansion needed by 2015-20 and beyond.</p> <p>Nuclear fuel suppliers, banks and other investors.</p>

Technology development and deployment	Milestones and actors
<ul style="list-style-type: none"> While capturing the benefits of replicating standardised designs to the extent possible, continue the evolutionary development of reactor and nuclear fuel designs to benefit from experience gained in building reference plants and from technological advances, to ensure that nuclear power remains competitive. 	<p>Lessons learned from reference plants will be available from 2015; major changes to standardised designs unlikely before 2020.</p> <p>Nuclear suppliers, electricity utilities.</p>
<ul style="list-style-type: none"> In co-operation with nuclear research institutes, participate in the development of next generation nuclear systems (reactors and fuel cycles), to ensure that the designs selected for demonstration are those most suitable for eventual commercialisation. 	<p>Demonstrate the most promising systems by 2030, with full commercialisation after 2040.</p> <p>Nuclear suppliers, electricity utilities.</p>

Actions led by other stakeholders

Financing nuclear power plants	Milestones and actors
<ul style="list-style-type: none"> Enhance the ability of the global financial community to assess the investment risks involved in nuclear power projects, to develop appropriate financing structures, and to provide suitable financial terms for nuclear investments. Participation in the financing of early nuclear construction projects will help strengthen nuclear expertise in the financial sector. 	<p>Develop increased expertise by participating in nuclear projects by 2020. Increase the availability of private sector finance after 2020.</p> <p>Banks and financial services companies, export credit agencies, multilateral development banks/ agencies.</p>

<i>International co-operation</i>	<i>Milestones and actors</i>
<ul style="list-style-type: none"> Maintain and strengthen where necessary international co-operation in areas such as institution-building in countries planning new nuclear programmes, harmonisation of regulatory requirements, radioactive waste management and disposal, development of advanced reactor and fuel cycle technologies, non-proliferation and nuclear law, physical protection of nuclear facilities and materials, and security of nuclear fuel supply. 	<p>Important issues need to be addressed in the 2015-20 timeframe if nuclear expansion is to become sufficiently broad-based after 2020.</p> <p>Intergovernmental nuclear and energy agencies (notably the International Atomic Energy Agency and the OECD Nuclear Energy Agency), international non-governmental industry and policy organisations.</p>

References

- GIF, 2002 *A Technology Roadmap for Generation IV Nuclear Energy Systems*. Generation IV International Forum (GIF), 2002. Available at www.gen-4.org/Technology/roadmap.htm.
- GIF, 2009 *Proceedings of the GIF Symposium*, Paris, 9-10 September 2009. Generation IV International Forum (GIF), 2009. Available at www.gen-4.org/GIF/About/index.htm.
- IAEA PRIS *Power Reactor Information System database*. International Atomic Energy Agency, Vienna. Available at www.iaea.org/programmes/a2/index.html.
- IAEA, 2007 *Milestones in the Development of a National Infrastructure for Nuclear Power*. International Atomic Energy Agency, Vienna, 2007.
- IEA, 2009 *World Energy Outlook*. International Energy Agency, Paris, 2009.
- IEA, 2010 *Energy Technology Perspectives*. International Energy Agency, Paris, 2010 (forthcoming).
- IEA/NEA, 2010 *Projected Costs of Generating Electricity, 2010 Edition*. International Energy Agency and OECD Nuclear Energy Agency, Paris, 2010.
- MDEP, 2009 *Multinational Design Evaluation Programme Annual Report 2009*. Available at www.nea.fr/mdep/.
- NEA, 2008 *Nuclear Energy Outlook*. OECD Nuclear Energy Agency, Paris, 2008.
- NEA, 2009 *The Financing of Nuclear Power Plants*. OECD Nuclear Energy Agency, Paris, 2009.
- NEA, 2010 *Uranium 2009: Resources, Production and Demand*. OECD Nuclear Energy Agency (jointly with the International Atomic Energy Agency), Paris, 2010 (forthcoming).
- WNA, 2009 *The Global Nuclear Fuel Market, Supply and Demand 2009-2030*. World Nuclear Association, London, 2009.



International
Energy Agency

Online bookshop

Buy IEA publications
online:

www.iea.org/books

PDF versions available
at 20% discount

Books published before January 2009
- except statistics publications -
are freely available in pdf

International Energy Agency • 9 rue de la Fédération • 75739 Paris Cedex 15, France

iea

Tel: +33 (0)1 40 57 66 90

E-mail:
books@iea.org

For further information on the Energy Technology Roadmaps project and to download other roadmaps, go to www.iea.org/roadmaps.

© OECD/IEA and OECD/NEA, 2010

Please note that this publication is subject to specific restrictions that limit its use and distribution. The terms and conditions are available online at www.iea.org/about/copyright.asp.

This report is the result of a collaborative effort between the IEA, the NEA, their member countries, and various consultants and experts worldwide. Users of this report shall make their own independent business decisions at their own risk and, in particular, without undue reliance on this report. Nothing in this report shall constitute professional advice, and no representation or warranty, express or implied, is made in respect of the completeness or accuracy of the contents of this report. The IEA and NEA accept no liability whatsoever for any direct or indirect damages resulting from any use of this report or its contents. A wide range of experts reviewed drafts. However, the views expressed do not necessarily represent the views or policy of the IEA, the NEA or individual member countries.

2010

2015

2020

2025

2030

